

Chemistry and Technology of Explosives

Vol. III

by

TADEUSZ URBAŃSKI

*Department of Technology, Politechnika
Warszawa*

Authorized translation by

MARIAN JURECKI

edited by

SYLVIA LAVERTON

PERGAMON PRESS

OXFORD · LONDON · EDINBURGH · NEW YORK
TORONTO · SYDNEY · PARIS · BRAUNSCHWEIG

PWN — POLISH SCIENTIFIC PUBLISHERS

WARSZAWA

Pergamon Press Ltd , Headington Hill Hall, Oxford
4 & 5 Fitzroy Square, London W. 1
Pergamon Press (Scotland) Ltd., 2 & 3 Teviot Place, Edinburgh 1
Pergamon Press Inc., 44-01 21 st Street, Long Island City, New York 11101
Pergamon of Canada, Ltd., 6 Adelaide Street East, Toronto, Ontario
Pergamon Press (Aust.) Pty. Ltd., 20-22 Margaret Street, Sydney, N.S.W.
Pergamon Press S. A. R. L., 24 rue des Écoles, Paris 5^e
Vieweg & Sohn GmbH, Burgplatz 1, Braunschweig

Copyright © 1967

by

PAŃSTWOWE WYDAWNICTWO NAUKOWE

PWN – Polish Scientific Publishers

Warszawa

Scan by Amenf

Interim image release.

First English edition 1967

Title of the original volume

Chemia i technologia materiałów wybuchowych

Library of Congress Catalog Card No. 63-10077

C
L
TP 210

Printed in Poland (D. U. A. M.)

1494/67

CONTENTS

Preface to Volume III	Page xiii
---------------------------------	--------------

Part 1

NITRAMINES

CHAPTER I. GENERAL INFORMATION

Structure and chemical properties of nitramines	1
Preparation of nitramines	8
Direct nitration	8
Indirect nitration	10
Nitramines as explosives	13
Literature	13

CHAPTER II. ALIPHATIC NITRAMINES AND NITRAMIDES

Nitramine (nitramide)	15
Methylnitramine	16
Methylenedinitramine	17
Ethylenedinitramine	18
Other nitramines deriving from ethylenediamine	20
Nitrocyanamide	21
Nitroguanidine	22
Physical properties	23
Chemical properties	25
Explosive properties	29
The preparation of nitroguanidine	31
Nitrourea	33
Other aliphatic nitramines	34
Dinitrodimethyloxamide (MNO)	34
Dinitrodiethyloxamide	35
Dinitrodimethylsulphamide	36
Nitrodiethanolamine dinitrate (DINA)	36
Dinitrodi-(β -hydroxyethyl)-oxamide dinitrate (NENO)	37
Dinitrodimethyldiamide of tartaric dinitrate	37
Dinitrodi-(β -hydroxyethyl)-sulphamide dinitrate	38
Literature	38

CHAPTER III. AROMATIC NITRAMINES

Tetryl	40
Nitration of dimethylaniline	41
Nitration of dinitromethylaniline	44
General rules for the preparation of tetryl	47
Physical properties	48
Chemical properties	51
Explosive properties	53
Toxicity	56
Tetryl manufacture	56
Homologues and analogues of tetryl	62
The polycyclic analogues of tetryl	68
Nitramino-esters of nitric acid	70
Nitraminonitrophenols	72
Nitramino-azoxy compounds	73
Nitro methylene blue	73
Literature	74

CHAPTER IV. HETEROCYCLIC NITRAMINES

Cyclonite	77
Physical properties	78
Chemical properties	80
Explosive properties	84
Toxicity	86
Cyclonite manufacture	87
1. The action of nitric acid on hexamine	87
2. Preparation of cyclonite from hexamine, nitric acid and ammonium nitrate	105
3. Preparation of cyclonite from sulphamic acid, formaldehyde and nitric acid	107
4. Preparation of cyclonite from paraformaldehyde, ammonium nitrate and acetic anhydride	109
5. Preparation of cyclonite from hexamine dinitrate, ammonium dinitrate and acetic anhydride	111
The theory of cyclonite formation by methods 4 and 5	113
Octogen	117
Homocyclonite	119
Nitro derivatives of melamine	120
Nitrosamines	121
Literature	125

Part 2

PRIMARY EXPLOSIVES: INITIATORS

CHAPTER I. GENERAL INFORMATION

Literature	131
----------------------	-----

CHAPTER II. FULMINIC ACID AND ITS SALTS

Fulminic acid	132
Mercury fulminate	135

Physical properties	136
Chemical properties	139
Explosive properties	146
Toxicity	149
Mercury fulminate manufacture	149
Other salts of fulminic acid	157
Literature	158

CHAPTER III. HYDRAZOIC ACID AND ITS SALTS

Hydrazoic acid	161
Lead azide	169
Lead azide manufacture	178
The continuous method of lead azide manufacture (according to Meissner)	179
Silver azide	182
Cupric azide	185
Other metal azides	185
Organic azides	191
Literature	196

CHAPTER IV. OTHER INITIATING EXPLOSIVES

Diazo compounds	201
Dinitrobenzenediazo-oxide (dinitrodiazophenol)	201
The derivatives of aminoguanidine	206
Tetrazene	206
Nitrosoguanidine	210
Cyanamide salts	211
Nitrocyanamide salts	211
Nitrophenol salts	212
Lead picrate	212
Lead styphnate	213
Other styphnates	220
Lead dinitroresorcinatate	220
Nitrosophenol salts	221
Nitramine salts	221
"Isonitramine" (nitrosohydroxylamine) salts	221
Salts of metazonic acid	224
Salts of oxalic acid	224
Peroxides	225
Acetylene and its salts (acetylides)	227
Cuprous acetylide	227
Silver acetylide	229
Various initiators	229
Nitrogen sulphide	229
Nitrogen selenide	229
Salts of thiocyanic acid	230
Complex salts	230
Silver perchlorate	232
Initiating compositions	232
The preparation of primer compositions	235
Compositions for explosive rivets	240
Literature	240

Part 3

COMPOSITE EXPLOSIVES

General information	245
-------------------------------	-----

CHAPTER I. HIGH EXPLOSIVES

Fusible explosives	247
Mixtures of nitro compounds	247
Mixtures with ammonium nitrate	253
Manufacture and selection of fusible mixtures	255
The phlegmatization of fusible mixtures	257
Semi-fusible and infusible explosives	258
Mixtures with nitrates—mainly with ammonium nitrate	259
Mixtures with aluminium and other metals	266
Mixtures with chlorates and perchlorates	274
Mixtures with potassium and ammonium perchlorates	278
Plastic explosives	281
Incompatibility in explosive mixtures	283
Literature	285

CHAPTER II. LIQUID EXPLOSIVES

Historical	288
Mixtures with nitrogen dioxide, nitric acid and tetranitromethane	288
Mixtures with hydrogen peroxide	290
Mixtures with liquid oxygen (Oxyliquits)	290
Liquid rocket propellants—propergols	291
Mixtures with nitrogen dioxide	291
Mixtures with nitric acid	292
Hydrogen peroxide H_2O_2	299
Hydrazine	305
1,1-Dimethylhydrazine (UDMH)	308
Mixtures with liquid oxygen and ozone	309
Nitric esters	309
Ethylene oxide	310
Attempts to increase the energy of liquid mixtures for rocket propulsion	310
Mixtures with powdered metals	311
Boron, silicon and beryllium compounds	311
Organometallic compounds	312
Fluorine and its derivatives	312
Mixtures with perchloric acid	313
Reactions of free atoms or radicals	316
General considerations	316
Final remarks	318
Literature	319

CHAPTER III. BLACKPOWDER

Historical	322
Composition of blackpowder	324
Preparation of blackpowder	328

Modified blackpowder	330
Theory of the burning of blackpowder	335
Explosive properties of blackpowder	340
The manufacture of blackpowder	342
Raw materials	342
Milling the ingredients	345
Mixing the ingredients	349
Pressing	352
Corning	354
Finishing	356
Blending	359
Cannon powder	359
Safety in blackpowder factories	361
Literature	363

CHAPTER IV. COMPOSITE PROPELLANTS FOR ROCKETS

General information	365
Mixtures with the salts of perchloric acid	367
Mixtures of perchlorates with elastomers, Thiokol propellants	368
The technology of the manufacture of rocket charges containing composite propellants with thiokol	373
Mixtures of perchlorates with other elastomers	380
Mixtures of perchlorates with plastics	380
Mixtures with ammonium nitrate	383
New method of mixing ingredients of composite propellants	389
Various composite propellants and their characteristics	392
Mixtures with ammonium picrate	393
Explosive properties of composite propellants	393
Literature	393

CHAPTER V. MINING EXPLOSIVES

Research on the safety of mining explosives	396
Safety explosives before World War I	403
Conditions of shotfiring in mines	406
Mining explosives used during World War I	408
Research after World War I	409
General consideration on safety of explosives	413
Fundamental components of mining explosives	420
Oxygen carriers	421
Active ingredients and combustibles	423
Oxygen balance	423
Inert ingredients increasing safety	427
Inert neutralizing agents	432
Tests for mining explosives	433
Transmission of detonation	433
Sensitiveness to detonation	434
Power of explosives	438
Safety tests with methane and coal-dust	439
Application of statistics to gallery testing of explosives	445

Stability of mining explosives	446
Mining explosives used in various countries	446
Belgium	447
Czechoslovakia	448
France	451
Germany	455
Great Britain	461
Hungary	468
Japan	468
Poland	475
U.S.A.	480
U.S.S.R.	484
Combined blasting and water infusion for coal breaking	489
Liquid oxygen explosives (Oxyliquits)	491
Some other peaceful applications of explosives	495
Literature	495

CHAPTER VI. THE MANUFACTURE OF MINING EXPLOSIVES

The manufacture of ammonium nitrate explosives	498
Ammonium nitrate-fuel oil mixtures	508
The manufacture of dynamites	511
The manufacture of chlorate and perchlorate explosives	520
Cardox, Hydrox and Airdox cartridges	521
Literature	526

CHAPTER VII. SMOKELESS POWDER

Historical	528
Properties of smokeless powder	532
Physical properties	532
Explosive properties	532
Mechanical properties	543
Flash and methods for suppressing it	544
Smoke formation	548
Erosiveness of smokeless powder	548
Stability of smokeless powder	550
Stability tests	557
Stabilization of smokeless powder	559
Stabilization with diphenylamine	559
Inorganic stabilizers	563
Organic stabilizers	564
Apparent stabilizers	567
Literature	567

CHAPTER VIII. THE MANUFACTURE OF SMOKELESS POWDER

Introduction	570
Nitrocellulose powder	571
Nomenclature	571
Manufacture of nitrocellulose powder	573
The dehydration of nitrocellulose	573

The preparation of nitrocellulose mixtures	582
Partial dissolution of nitrocellulose	583
Shaping the dough	590
The stabilization of an unstable powder	632
Ball-grain powder	632
Nitrocellulose bulk powder (Schultze powder)	640
Double base powders	641
Nitroglycerine powders with a volatile solvent	642
Solventless nitroglycerine powders	644
Solventless powders with a low content of nitroglycerine	652
The manufacture of solventless powder in German factories	660
Solventless powder in Japan	663
Flashless charges and flashless powders	663
Smokeless powder with penthrite	670
Smokeless powders containing nitroaliphatic compounds	671
Smokeless powders for rockets	671
Cast double base propellants	675
General safety considerations in the manufacture of smokeless powder	682
Literature	686
Author index	689
Subject index	702
Errata to Volumes I and II	715

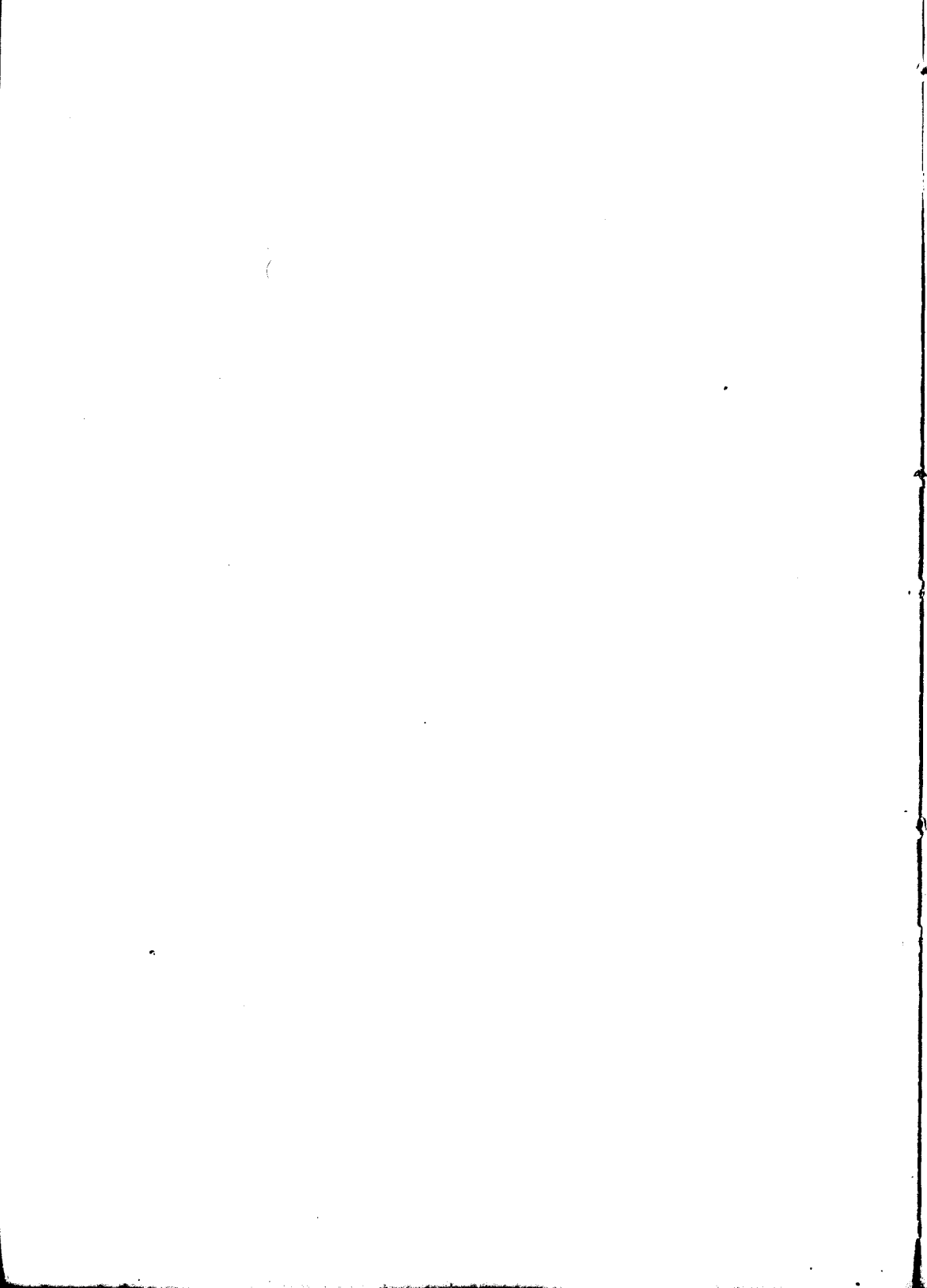

PREFACE TO VOLUME III

THE manuscript of Volume III was submitted to the publishers in 1960. Owing to the rapid progress in the many branches of chemistry and chemical technology that form the scope of this volume, some paragraphs became obsolete and it has therefore been necessary to add some new items and to rewrite certain paragraphs.

The necessary information obtained from the current literature has been supplemented with data from a number of colleagues who kindly made available some less accessible material. It is my pleasant duty to express my thanks to Prof. S. Claesson (Uppsala), Prof. M. A. Cook (University of Utah, Salt Lake City), Prof. W. Cybulski (Mikołów, Poland), Dr. L. Deffet (Sterrebeck, Belgium), Dr. R. W. Van Dolah (Pittsburgh, Pa.), Dr. A. G. Grenier (Dow Chemical International, Midland, Michigan), Prof. J. Hackel (Warsaw), Prof. M. Kryszewski (Łódź), Dr. J. Meissner (Frankfurt a./M.), Prof. H. Sudo (Tokyo), Dr. A. Wetterholm (Gyttorp, Sweden) and to the firms: Draiswerke G.m.b.H., Maschinenfabrik (Mannheim-Waldhof), Olin Industries, Inc. (East Alton, Ill.), H. Orth G.m.b.H. Fachbüro für Verfahrenstechnik (Ludwigshafen-Oggersheim, Pfalz), Werner & Pfleiderer, Maschinenfabriken und Ofenbau (Stuttgart).

Some of the problems, such as safety in coal mines, merit a special monographic treatment which should go far beyond the scope of this volume. Therefore safety in coal mines was tackled only from the point of view of the composition of coal mine explosives.

Another rapidly developing branch of applied science is theory and practice of rocket propulsion. Only general information on composition of rocket propellants is given in the book. This is justified, as several special books on rocket fuel are now available.

My thanks are due to the translator, Mr. M. Jurecki and to Mrs. Sylvia Laverton, F.R.I.C. for tidying up the English text and to Mrs. A. Malawska, M.Sc. for her skilled editorial work.

AUTHOR

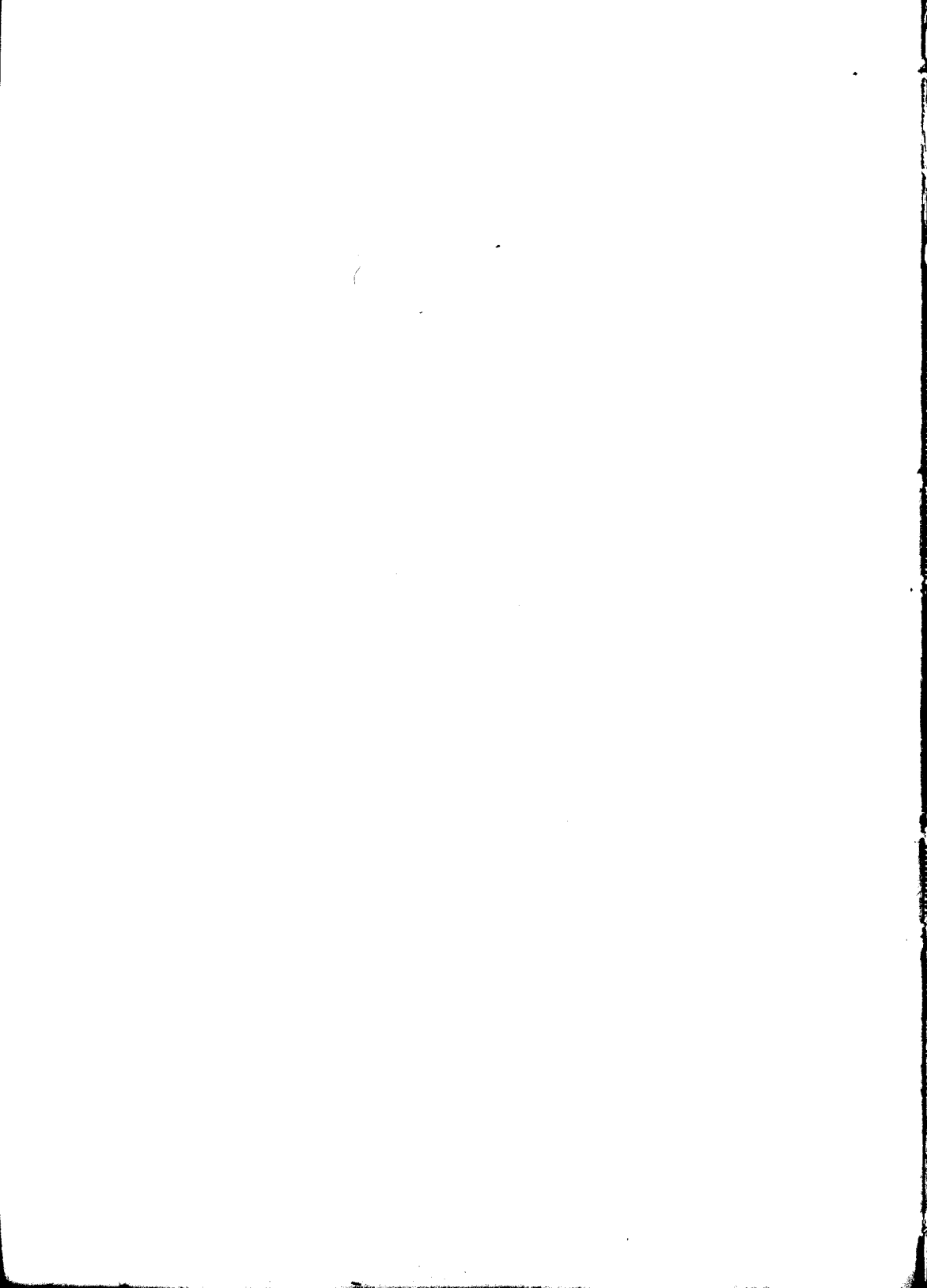

Part 1

NITRAMINES

CHAPTER I

GENERAL INFORMATION

NITRAMINES are substances which contain a nitro group bonded to the nitrogen atom: >N-NO_2 .

In formal terms all nitramines may be regarded as derivatives of the simplest inorganic nitramine, NH_2NO_2 . If only one hydrogen is replaced by an alkyl or aryl group, the resulting substance is a primary nitramine, if two hydrogens are replaced, secondary nitramines are formed:

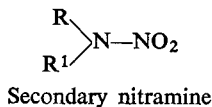
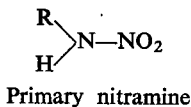

Nitramines may also be said to include nitramides (primary and secondary) which differ from nitramines proper in that one of the groups (R) is acyl or sulphonyl.

STRUCTURE AND CHEMICAL PROPERTIES OF NITRAMINES

The existence of a bond in nitramines linking the nitrogen atom of the nitro group with that of the amino group is proved by the formation of hydrazine derivatives by the reduction of nitramines. Secondary nitramines give a particularly high yield of hydrazine derivatives.

There exists a group of compounds isomeric with primary nitramines, which also yield hydrazine derivatives when reduced. These compounds are nitrosohydroxylamine derivatives:

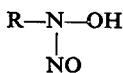

This structure was deduced from their mode of preparation: nitrosohydroxylamines are obtainable by nitrosation, nitramines by nitration. The physical properties of primary nitramines are entirely different from those of nitrosohydroxylamines, so that phenylnitramine $C_6H_5NHNO_2$, for example, differs radically from phenylnitrosohydroxylamine

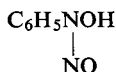

Traube's "isonitramines", which are described later in this volume, are nitrosohydroxylamines.

The existence of an N—N bond in primary nitramines is also proved by the fact that these substances are obtained by the oxidation of diazo compounds. Additional evidence that nitramines contain a nitro and not a nitrite group and hence have a structure different from $R-N-ONO$ is provided by the fact that nitramines are relatively resistant to alkali, whereas nitrous esters are highly unstable.

These inferences concerning the structure of nitramines, based on their chemical properties, are confirmed by the data obtained by X-ray analysis of the simple nitramines: dimethylnitramine and ethylenedinitramine. In particular, Costain and Cox [1], and Llewellyn and Whitmore [2], established that the grouping

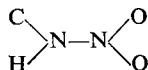

is planar. Bond angles and interatomic distances are shown in Fig. 1.

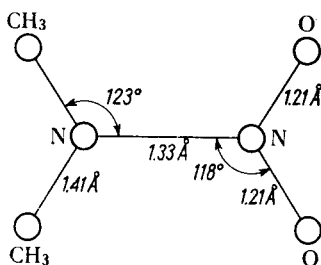

FIG. 1. Structure of the nitramino group, with dimethylnitramine as an example (not to scale).

Thus, in principle, the dimensions of the nitro group in both aromatic and aliphatic nitro compounds are identical.

Nitramines dissolved in water, alcohol or dioxane, give a broad ultra-violet absorption band, the maximum of which lies between 225 and 240 μ .

R. N. Jones and Thorn [3] adduce the two following typical absorption curves for nitramines: a primary — ethylenedinitramine — Fig. 2 and a secondary — 2,5-dinitro-2,5-diazahexane (according to R. N. Jones and Thorn) — Fig. 3. They have also been investigated by Baly and Desch [4], Franchimont and Backer [5], Carmack and Leavitt [6] and Corey, Dekker, Malmberg, Le Rosen, and Schroeder [7].

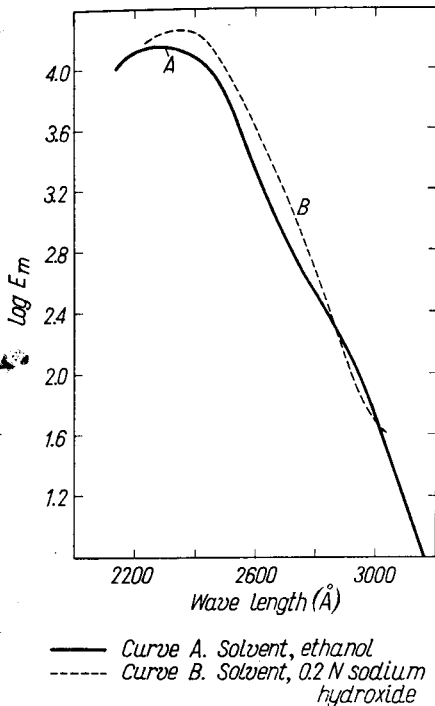

FIG. 2. Spectrum of typical primary nitramine (ethylenedinitramine), according to R. N. Jones and Thorn [3].

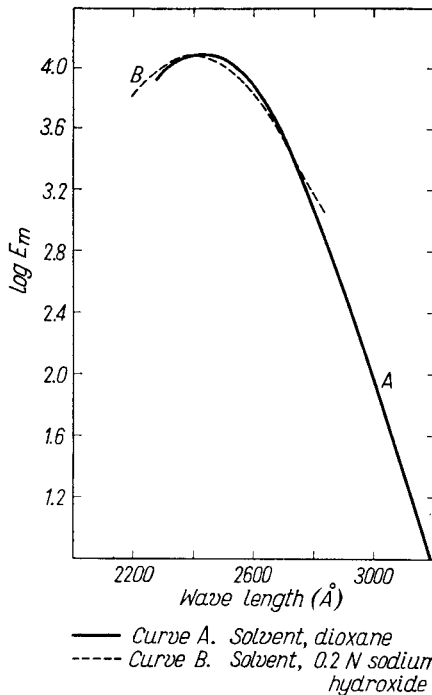

FIG. 3. Spectrum of typical secondary nitramine (2,5-dinitro-2,5-diazaheptane), according to R. N. Jones and Thorn [3].

The ultra-violet absorption spectra of nearly 60 nitramines were examined by R. N. Jones and Thorn, who drew up an interesting rule about the coefficient of extinction for nitramines.

According to this rule, compounds which contain one primary nitramine group show a coefficient of extinction in the maximum of the absorption curve, ϵ_{\max} , equal to approximately 7000. If the molecule contains n primary nitramine groups, ϵ_{\max} increases in proportion to the number of nitramine groups, i.e. $\epsilon_{\max} = 7000 n$. This empirical rule is valid for values of n ranging from 1 to 3. For secondary nitramines, $\epsilon_{\max} = 5500$. If the number of secondary nitramine groups is n , $\epsilon_{\max} = 5500 n$. This rule is valid for values of n ranging from 1 to 4. If both primary and secondary nitramines occur together in a molecule, ϵ_{\max} is the sum of the appropriate multiples of 7000 and 5500.

The infra-red spectra of nitramines show approximately the same frequencies as ordinary nitro compounds (Lieber, Levering and Patterson [8], Salyamon and Yaroslavskii [9], Salyamon and Bobovich [9] and Bellamy [10]).

On the basis of these authors' results, Bellamy states that the nitro group in nitramines has the following vibration frequencies:

- asymmetric $1587\text{--}1530\text{ cm}^{-1}$
- and symmetric $1292\text{--}1260\text{ cm}^{-1}$.

According to Bellamy, these values may be considered as the average for all nitramines except nitroguanidine which, as the investigations of Lieber and his co-workers and of Kumler have shown, has a very high frequency of asymmetric vibration, i.e. ranging 1655–1620 cm^{-1} .

Similar deviations are shown by nitrourea. Presumably these are caused by the existence of tautomeric forms.

Nitramines show no basic properties whatever — indeed, primary nitramines have distinct acidic properties and can form salts with alkalis. Conversely, nitramides may be more strongly acidic than carboxylic acids, as, for example, nitro-urethane, which is a stronger acid than formic acid.

Primary amines react slowly with ammonia in a benzene medium, to form ammonium salts. Hence Hantzsch [11] assumed that primary nitramines (I), like primary and secondary nitroparaffins, are pseudoacids and react in a tautomeric aci-form (II)

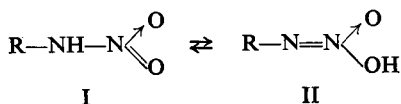

This view was generally accepted. It was based, however, not so much on experimental evidence as on Hantzsch's personal authority. In point of fact Euler [12] found that the rate of formation of the ammonium salt is by no means as slow as Hantzsch believed and expressed doubt as to the existence of the supposed tautomerism. No further evidence confirming the existence of the aci-form was forthcoming until the O-alkyl derivatives, e.g. O-methyl-methylnitramine (III),

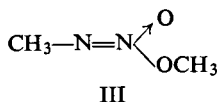

isomeric with dimethylnitramine (Gillibrand and Lambertson [13]), were obtained.

That the compound (III) actually has such a structure is proved by the fact that on hydrolysis with 40% sulphuric acid two molecules of methyl alcohol are formed:

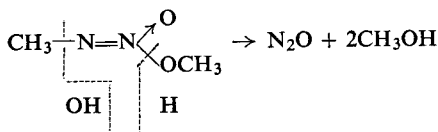

One of the characteristics of nitramines is the ease with which they decompose in sulphuric acid. Primary nitramines undergo decomposition with particular ease; alcohol is formed and N_2O is evolved on boiling in dilute (2%) sulphuric acid (van Erp [14], Backer [15]):



Secondary nitramines are more stable towards sulphuric acid and decomposition rarely occurs until 40% or more sulphuric acid is used at a temperature of 100°C.

Concentrated nitric acid decomposes some primary nitramines; methylnitramine, for example, is decomposed by anhydrous nitric acid, even at a temperature below 0°C, to form methyl nitrate and N₂O (Franchimont [16]).

Rearrangement of primary and secondary aromatic nitramines occurs in an acid medium with the formation of C-substituted aniline derivatives (Bamberger and Landsteiner [17]).

Dinitrophenylmethylnitramine, for example, on treatment with nitric and sulphuric acid, is rearranged to form trinitro-N-methylaniline:

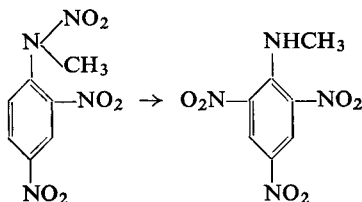

Hughes and Ingold [18] suggest the following explanation of the rearrangement:

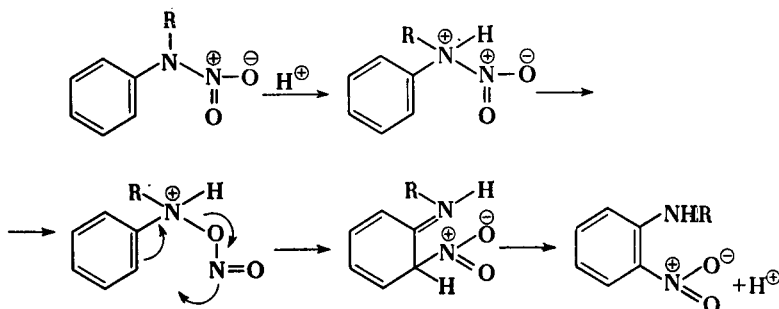

This rearrangement, which is of great importance for the manufacture of tetryl, will be illustrated when the production of this substance is discussed.

The majority of aromatic-aliphatic nitramines undergo denitration on heating with phenol, especially in the presence of sulphuric acid. Tetryl, for example, undergoes the following reaction:

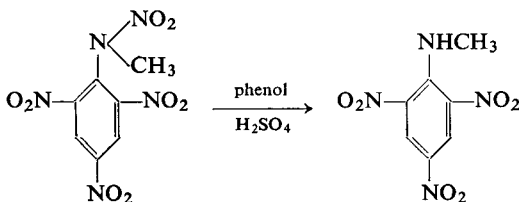

Nitramines dissolved in concentrated sulphuric acid give a blue colour with diphenylamine reagent.

With primary nitramine sulphuric acid may promote the separation of nitric acid, which results in extensive decomposition of the substance. This will be discussed in more detail when dealing with nitroguanidine (p. 26).

There is as yet no evidence that in the presence of sulphuric acid secondary amines lose nitric acid which would be capable of nitrating phenol. Attack by concentrated sulphuric acid, presumably loosens the linkage between the nitrogen atoms, leading to the expulsion of the nitronium ion NO_2^{\oplus} , which is a nitrating agent.

Most nitramines are fairly resistant to alkalis. Some of the primary amines, e.g. the simple aliphatic ones, are not susceptible to decomposition even under the influence of a hot, 20% solution of potassium hydroxide (van Erp [14]). On the other hand, Hantzsch and Metcalf [19] found that N-nitraminoacetic acid is decomposed by sodium hydroxide. According to Barrott, Gillibrand and Lamberton [20] most primary amines undergo decomposition on treatment with a solution containing 0.8–8% of NaOH at a temperature of 95°C. The reaction proceeds according to the formula:

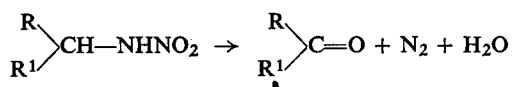

The concentration of alkali required depends on the properties of the radicals R and R¹. The more electrophilic the radicals and the more acidic the nitramine, the easier the course of reaction. Secondary nitramines are decomposed by an aqueous solution of sodium hydroxide. The reaction conditions, including the concentrations of NaOH solutions differ according to the substance. Van Erp and Franchimont [21] found that the reaction proceeded by the following mechanism:

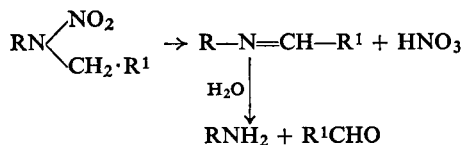

Various products are formed by the reduction of nitramines, depending on the reaction conditions.

Vigorous reduction may involve the rupture of the N—N linkage with the formation of amine and ammonia. Milder reducing agents yield different products, including hydrazine derivatives, e.g.:

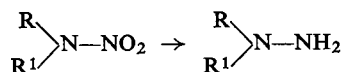

Such a reduction may occur quantitatively and hence may be utilized for analytical purposes. According to Cope and Barab [22], the Schulze-Tiemann ($\text{FeCl}_2 + \text{HCl}$) or Lunge ($\text{Hg} + \text{H}_2\text{SO}_4$) methods are suitable for this purpose. In both cases the reaction proceeds as follows:

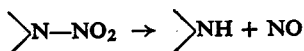

The reaction of primary aromatic nitramines with nitrous acid is specific and leads to the formation of diazonium nitrate (Bamberger [23]). According to Stevens [24] this reaction is also a kind of reduction, and presumably may be represented as follows:

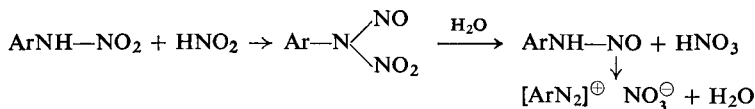

Primary nitramines react with diazomethane to yield N-methyl or O-methyl derivatives.

Thus, methylnitramine is converted into dimethylnitramine and phenylnitramine into phenyl-O-methylnitramine:

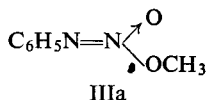

As early as 1910, Franchimont [16] observed that primary nitramines (and nitro-paraffins) react with formaldehyde and secondary amines (e.g. piperidine). The formation of aminomethylnitramines (IV) then occurs:

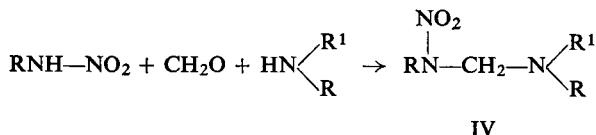

It was shown (Woodcock [25]) that intermediate hydroxymethyl compounds may be formed as for example those of type (V)

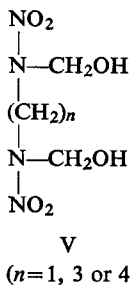

According to Lamberton and his co-workers [26], equilibrium is established in an aqueous solution:

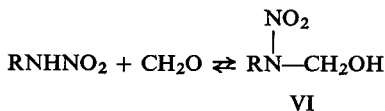

The hydroxymethyl derivative (VI) is, however, more stable in an acid medium. In a neutral medium the equilibrium shifts markedly to the left.

PREPARATION OF NITRAMINES

Nitramines and nitramides arise in various ways depending on the amines and amides subjected to nitration. There are direct and indirect nitration methods.

DIRECT NITRATION

Direct nitration with anhydrous nitric acid (98%) can be accomplished most conveniently in the presence of monosubstituted N-alkylamides. A secondary nitramide is then formed:

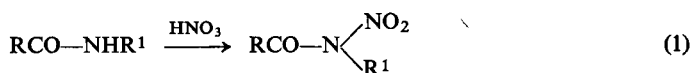

One of the direct methods of nitrating primary amines is based on this reaction. An amine is acylated to form a primary amide which is in turn nitrated according to reaction (1) and then hydrolysed to release the acyl group. This procedure will be discussed more fully in later chapters.

Generally, reaction (1) is not successful with non N-substituted, i.e. primary amides, most of which undergo decomposition when nitrated. Primary aliphatic amines also decompose under the action of concentrated nitric acid.

Similarly, primary aromatic amines undergo complex reactions when heated with nitric acid. The amine derivatives of anthraquinone, pyridine and thiazole are exceptions: the amino group in these compounds is decomposed by the nitrating mixture. This was noticed by Scholl [27], who proposed the following method for nitrating β -aminoanthraquinone:

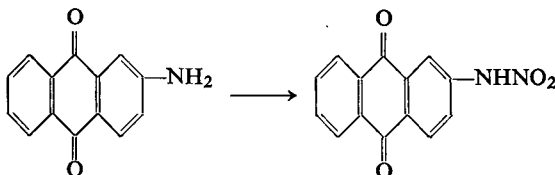

Chichibabin [28] and Razorenov observed that the amino derivatives of pyridine are nitrated in a similar way. For example, a mixture of nitric and sulphuric acids converts α -amino-pyridine into α -nitramino-pyridine.

Ganapathi and Venkataraman [29] found that aminothiazole and its homologues can be nitrated in the same way, using a double excess of nitrating mixture.

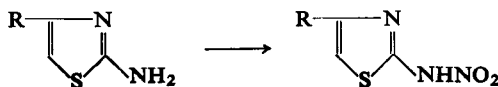

In addition to the compound (I), a certain amount of a compound (II) nitrated in the ring is formed when a stoichiometric quantity of HNO_3 is used. As the investigations of Wright *et al.* [30] subsequently showed, the compound (II) is also obtainable when aminothiazole is treated with a nitrating mixture containing 10–30% of water.

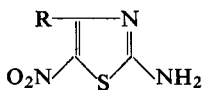

II

At an earlier stage Orton [31] found that some aniline derivatives which are difficult to nitrate in the ring, are liable to form N-nitramines when treated with nitric acid and acetic anhydride. For example, he prepared the corresponding nitramine from 2,4,6-tribromaniline:

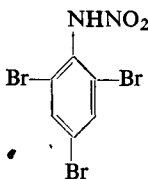

The nitration of secondary amines by the above method is generally successful:

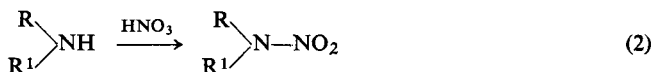

It is noteworthy that the conversion of the group >NH into >N-NO_2 is not always practicable. As early as 1916 Franchimont and Dubsy [32] called attention to the fact that if the group >NH has the properties of an imido group (for example -CO-NH-CO-), it is not susceptible to nitration, while the same group with amido characteristics (for example $\text{-CO-NH-CH}_2\text{-}$) is readily nitrated. Developing this observation, Wright *et al.* [33, 34] were led to the discovery that very weakly basic amines with the >NH group (e.g. in the form of $\text{-CH}_2\text{-NH-CH}_2\text{-}$) are nitrated more readily than strong bases with the same group. Strong bases require the addition of a catalyst for nitration (for example, ZnCl_2 , HCl ; this will be discussed in later chapters) whereas weak bases can be nitrated without a catalyst. Amines of the type $\text{R-CH}_2\text{-NH-CH}_2\text{-R}$, for example, where $\text{R} = \text{CN}$, COOH or CONH_2 , i.e. amines of a considerably diminished basicity, are nitrated relatively easily.

In some more complex cases, secondary amines can be nitrated with nitrating mixtures. Diethanolnitramine dinitrate (DINA), for example, can be prepared by the action on diethanolamine of a mixture of nitric acid, nitric anhydride and zinc chloride (this is dealt with in more detail on p. 10).

Some amines undergo direct nitration during nitrolysis; nitration is then followed by partial degradation involving the cleavage of the bond between the carbon and nitrogen atoms (p. 12).

INDIRECT NITRATION

Nitration by the "dehydration" of the amine nitrate

This method is commonly applied to the nitration of primary amines (3) and in particular the preparation of nitroguanidine, nitrourea etc., as well as in the nitration of secondary amines (4):

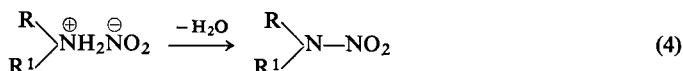
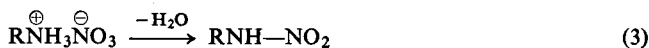

It was applied by Bamberger and Kirpal [35] in the preparation of dimethylnitramine and nitropiperidine with a rather poor yield. They used acetic anhydride as a dehydrating medium.

Wright *et al.* [33, 36] found that the yield of nitramines was considerably improved by adding zinc chloride or hydrogen chloride to the acetic anhydride. Under such conditions dimethylamine yields 65% of dimethylnitramine. It is not impossible that the essence of the action of these additions is to reduce the basicity of the amine and thus facilitate the introduction of a nitro group in accordance with the rule outlined above.

Another method of "dehydration" of the amine nitrate is based on treatment with concentrated sulphuric acid. This is used commercially in manufacturing such primary amines as nitroguanidine (p. 31).

Nitration of primary amines by acylation

This method involves acylation of the primary amine by introducing an acetyl or oxalyl group followed by nitration of the secondary amine so formed in accordance with the reaction (1). The product thus nitrated undergoes alkaline hydrolysis to yield a primary nitramine:

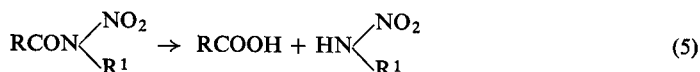

Very frequently the transition through urethanes is employed by treating the primary amine with chloroformate. The N-substituted urethane so obtained is nitrated by substituting the free N-hydrogen and then subjecting the product to alkaline hydrolysis which results in the formation of the salt of a primary nitramine and a base. The free nitramine is obtained by acidification.

This type of reaction can be illustrated by the nitration of methylamine according to Franchimont [37] (6):

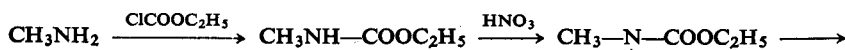

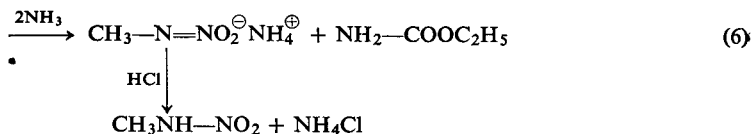

The method was later worked out by Brian and Lamberton [38] to produce previously unobtainable nitramines.

The formation of nitramines through chloramines

This method was originally suggested by Berg [39]. It consists in acting with silver nitrate on chloramines:



Wright *et al.* [40] elaborated a new method of preparing nitramines by acting on chloramines with nitric acid in the presence of acetic anhydride. A typical example is the preparation of *sec*-butylnitramine (III) (Smart and Wright; Suggitt, Myers and Wright [40]) from dichloramine (I):

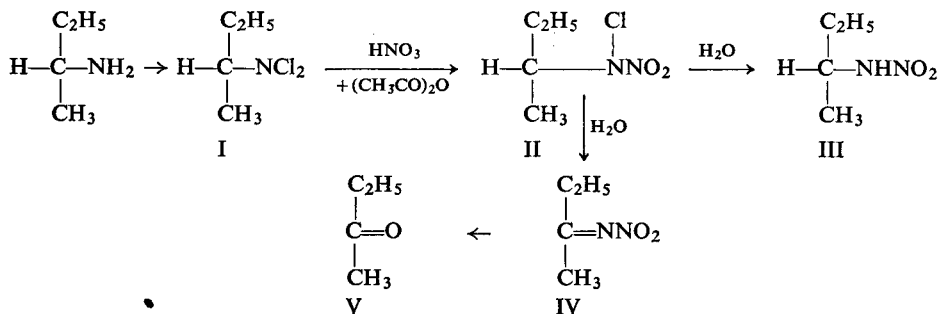

The intermediate (II) is unstable and is hydrolysed in water to form (III) and (IV). The latter (2-butanenitramine) is also unstable and decomposes to butanone-2 (V).

The intermediate formation of chloramine explains the catalytic action of hydrochloric acid in the nitration of amines, as mentioned above. The following reaction mechanism was drawn up by Wright [41]

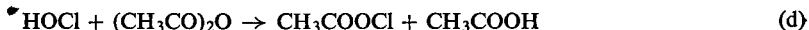
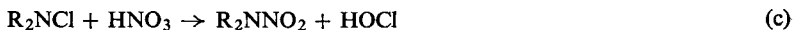

Thus hydrochloric acid reacts in the presence of nitric acid to yield chlorine acetate (a)—a compound with cationic chlorine. The latter in turn forms a chloramine (b) which is nitrated to a nitramine (c).

The mechanism of the nitration of amines has not yet been explained fully. Wright *et al.* [34, 42] suppose that the nitration of secondary amines and probably of

secondary amides takes place by the formation of intermediate complexes between the amine and nitric acid. It is probable that the bond N—N is formed, followed by the loss of HOX (7):

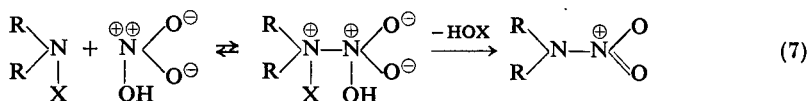

In catalysed reactions X represents Cl, in uncatalysed reactions it represents H.

This scheme, however, has the disadvantage of ignoring the influence of the nitronium ion (NO_2^{\oplus}) on the reaction, whereas, as expounded in the chapter on nitration theories (Vol. I), the nitronium ion is of enormous importance for such a reaction. In this connection Lamberton [43] suggests alternative schemes which appear more probable. Scheme (8) leads to the formation of a nitramine and scheme (9) to a salt of nitric acid:

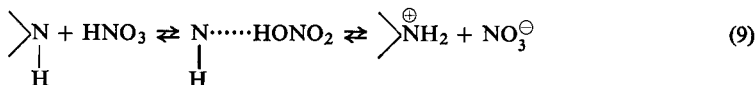
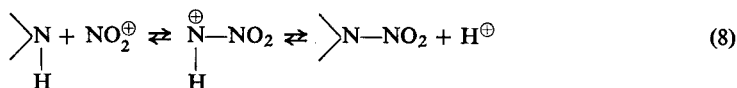

Where there are strong bases which are nitrated with difficulty, reaction (9) predominates over reaction (8). At the same time Lamberton called attention to the reversibility of reaction (9). Indeed, it is known that nitramines such as nitroguanidine or nitrourethanes exhibit nitrating properties in the presence of sulphuric acid, thus behaving as if they can split off the nitronium ion or the nitric acid molecule.

Nitration by nitrolysis

The term "nitrolysis" suggested by Linstead [44] is usually applied to a nitrating mechanism in which both the rupture of C—N bond and the formation of a nitramine occur simultaneously with the formation of alcohol which subsequently undergoes esterification (10):

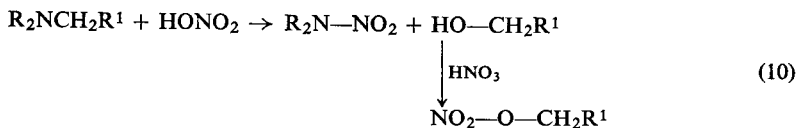

Nitrolysis may also proceed without giving rise to alcohol in accordance with eqn. (11). Nevertheless, a nitric ester is formed by the possible action of the NO_3^{\ominus} ion on a free alkyl cation:

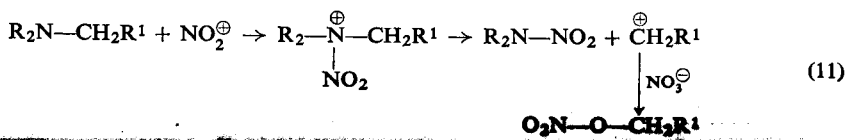

As these equations suggest, the nitration of an amide may lead to a nitramine or a nitramide, according to reaction (12a) or (12b):

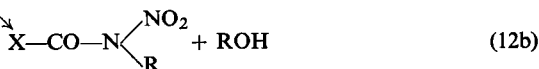
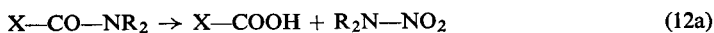

The nitration of hexamethylenetetramine, which contains the grouping

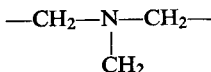

to produce cyclonite, is also a nitrolysis reaction. In addition to cyclonite, a nitrate of methylene glycol is also formed as a result of the cleavage of one of the three linkages between each nitrogen and carbon atom:

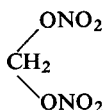

Other methods for the preparation of nitramines

Some nitramines may be prepared without treating amines with nitric acid. The classical example is the so-called "E-method" of cyclonite preparation in which a nitramine is formed by dehydration of a mixture of paraformaldehyde and ammonium nitrate, i.e. without using either amine or nitric acid (this will be discussed more fully on p. 109). When a nitramine is required with a non-nitrated aromatic ring which readily undergoes nitration with nitric acid, Bamberger's method [45], involving the oxidation of diazo compounds (13), may be applied.

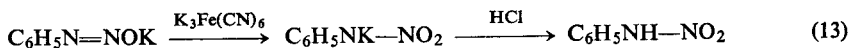

NITRAMINES AS EXPLOSIVES

Nitramines differ from nitro compounds in possessing a somewhat better oxygen balance, due to the fact that the group N—NO₂ gives twice the volume of nitrogen as the group C—NO₂. On the other hand nitramines have a worse oxygen balance than nitric esters.

As regards explosive strength, nitramines occupy a position midway between nitro compounds and nitric esters. They also hold a central position regarding other properties, such as chemical stability and sensitiveness to impact and friction.

LITERATURE

1. W. COSTAIN and E. G. COX, *Nature* **160**, 826 (1947).
2. F. J. LLEWELLYN and F. E. WHITMORE, *J. Chem. Soc.* **1948**, 1316.
3. R. N. JONES and G. D. THORN, *Can. J. Research* **27 B**, 828 (1949).
4. E. C. C. BALY and C. M. DESCH, *J. Chem. Soc.* **93**, 1747 (1908).

5. A. P. N. FRANCHIMONT and H. J. BACKER, *Rec. trav. chim.* **32**, 327 (1913).
6. M. CARMACK and J. J. LEAVITT, *J. Am. Chem. Soc.* **71**, 1221 (1949).
7. B. B. COREY, A. O. DEKKER, E. W. MALMBERG, A. L. LE ROSEN and W. A. SCHROEDER, Report No. P.B. 18856, Dept. of Commerce, Washington D.C.
8. E. LIEBER, D. R. LEVERING and L. J. PATTERSON, *Anal. Chem.* **23**, 1594 (1951).
9. G. S. SALYAMON and N. G. YAROSLAVSKII, *Sbornik Statei Obshch. Khim.* **2**, 1325 (1953); G. S. SALYAMON and YA. BOBOVICH, *ibid.* **2**, 1332 (1953).
10. L. J. BELLAMY, *The Infra-red Spectra of Complex Molecules*, Methuen, London, 1958.
11. A. HANTZSCH and F. E. DOLLFUS, *Ber.* **52**, 258 (1902).
12. H. EULER, *Ber.* **39**, 1607 (1906).
13. M. I. GILIBRAND and A. H. LAMBERTON, *J. Chem. Soc.* **1949**, 1883.
14. H. VAN ERP, *Rec. trav. chim.* **14**, 40 (1895).
15. H. J. BACKER, *Die Nitramine-Ahrens Sammlung* **18**, Stuttgart, 1912.
16. A. P. N. FRANCHIMONT, *Rec. trav. chim.* **29**, 296 (1910).
17. E. BAMBERGER and K. LANDSTEINER, *Ber.* **26**, 490 (1893).
18. E. D. HUGHES and C. K. INGOLD, *Quart. Rev.* **6**, 34 (1952).
19. A. HANTZSCH and W. V. METCALF, *Ber.* **29**, 1680 (1896).
20. J. BARROTT, M. I. GILIBRAND and A. H. LAMBERTON, *J. Chem. Soc.* **1951**, 1282.
21. H. VAN ERP and A. P. N. FRANCHIMONT, *Rec. trav. chim.* **14**, 224 (1895).
22. W. C. COPE and J. BARAB, *J. Am. Chem. Soc.* **38**, 2552 (1916); see also K. LEHMSTEDT and O. ZUMSTEIN, *Ber.* **58**, 2024 (1925).
23. E. BAMBERGER, *Ber.* **30**, 1248 (1897).
24. T. S. STEVENS, according to A. H. LAMBERTON [43].
25. D. WOODCOCK, *J. Chem. Soc.* **1949**, 1635.
26. A. H. LAMBERTON, C. LINDLEY, P. G. OWSTON and J. C. SPEAKMAN, *J. Chem. Soc.* **1949**, 1641.
27. R. SCHOLL *et al.*, *Ber.* **37**, 4427 (1904); R. SCHOLL and A. KRIEGER, *ibid.* **37**, 4681 (1904).
28. A. E. CHICHIBABIN and B. RAZORENOV, *Zh. Russ. Khim. Obshch.* **47**, 1280 (1915).
29. K. GANAPATHI and A. VENKATARAMAN, *Proc. Indian Acad. Sci.* **22 A**, 343 (1945).
30. J. B. DICKEY, E. B. TOWNE and G. F. WRIGHT, *J. Org. Chem.* **20**, 499 (1955).
31. K. J. P. ORTON, *J. Chem. Soc.* **81**, 806 (1902).
32. A. P. N. FRANCHIMONT and J. V. DUBSKY, *Rec. trav. chim.* **36**, 80 (1916).
33. W. J. CHUTE, G. E. DUNN, J. C. MACKENZIE, G. S. MYERS, G. N. R. SMART, J. W. SUGGITT and G. F. WRIGHT, *Can. J. Research* **26 B**, 114 (1948).
34. G. E. DUNN, J. C. MACKENZIE and G. F. WRIGHT, *ibid.* **26 B**, 104 (1948).
35. E. BAMBERGER and A. KIRPAL, *Ber.* **28**, 462, 535 (1895).
36. W. J. CHUTE, K. G. HERRING, L. E. TOOMBS and G. F. WRIGHT, *Can. J. Research* **26 B**, 89 (1948).
37. A. P. N. FRANCHIMONT, *Rec. trav. chim.* **13**, 308 (1894).
38. R. C. BRIAN and A. H. LAMBERTON, *J. Chem. Soc.* **1949**, 1633.
39. A. BERG, *Ann. Chim.* [7] **3**, 358 (1894).
40. J. C. MACKENZIE, G. S. MYERS, G. N. R. SMART and G. F. WRIGHT, *Can. J. Research* **26 B**, 138 (1948); G. S. MYERS and G. F. WRIGHT, *ibid.* **26 B**, 257 (1948); G. N. R. SMART and G. F. WRIGHT *ibid.* **26 B**, 284 (1948); J. W. SUGGITT, G. S. MYERS and G. F. WRIGHT, *J. Org. Chem.* **12**, 373 (1947).
41. G. F. WRIGHT in H. GILMAN's *Organic Chemistry*, Vol. IV, p. 951, J. Wiley, New York, 1953.
42. G. S. MYERS and G. F. WRIGHT, *Can. J. Research* **26 B**, 257 (1948).
43. A. H. LAMBERTON, *Quart. Rev.* **5**, 75 (1951).
44. R. P. LINSTAD, unpublished; quoted by A. H. LAMBERTON [43].
45. E. BAMBERGER and L. STORCH, *Ber.* **26**, 471 (1893); E. BAMBERGER, *ibid.* **27**, 359 (1894); **55**, 3383 (1922).

CHAPTER II

ALIPHATIC NITRAMINES AND NITRAMIDES

NITRAMINE (NITRAMIDE)

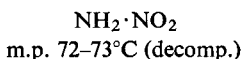

This is one of the simplest nitramines obtained by Thiele and Lachman [1] by the decomposition of nitrourethane:

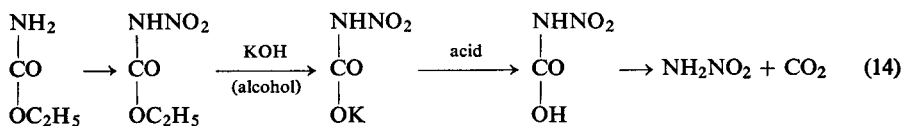

The structure of the compound was the subject of controversy for some time [2]. However, the latest experiments of Clusius [3] with ^{15}N -labelled nitramine have confirmed Thiele's formula [4]:



A carefully-devised method for preparing it was announced by Marlies, La Mer and Greenspan [5]. According to Bell and Wilson [6] the product contains some acidic impurities (about 1%), possibly unchanged nitrourethane.

This substance is an intermediate product of the decomposition of the important explosive nitroguanidine. It is also present in an aqueous solution of nitrourea or a sulphuric acid solution of nitrourea (Davis and Blanchard [7]).

Nitramine is believed to occur in an ammonium nitrate solution in an excess of concentrated sulphuric acid as a result of the dehydration of this salt:



Davis and Abrams [8] report the following experimental observations in support of this supposition. On heating a solution of ammonium nitrate in sulphuric acid to 150°C , nitric acid cannot be distilled, but nitrous oxide is evolved, probably from the decomposition of nitramine. If, however, the solution is kept for a long time between 90 and 120°C , nitric acid can be obtained by distillation. The authors'

conjecture is that the addition of water to the nitramine takes place according to the reaction (16):



Nitramine has explosive properties but it is not of any practical value for many reasons, primarily because of its high reactivity which impairs its chemical stability. It decomposes at a temperature as low as its melting point. At room temperature it decomposes slowly, to form nitrous oxide and water. On heating to 60–65°C decomposition occurs in an aqueous solution. It decomposes explosively on contact with concentrated sulphuric acid.

Bell and Caldin [9] and Caldin and Peacock [10] investigated the decomposition kinetics of nitramine under the influence of alkali in various solvents. Dimethylaniline was used as a base. According to Bell [11] the decomposition of nitramine proceeds through the formation of the aci-form:

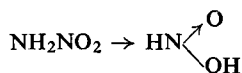

The reaction with a base B would then take the following course:

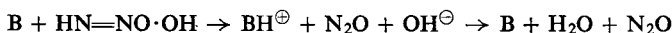

The rate and activation energy of decomposition depend to a great extent on the type of solvent used.

METHYLNITRAMINE



m.p. 38°C

This is a powerful explosive, stronger than tetryl but weaker than cyclonite. It is, however, of no practical value chiefly because its preparation is too expensive, requiring first the conversion of methylamine into urethane and then into its nitro derivative. On hydrolysis the latter yields methylnitramine. Similarly, the hydrolysis of dinitrodimehydroxamide (p. 35) leads to the formation of methylnitramine.

Methylnitramine is very readily soluble in water, alcohol, chloroform and benzene but is less soluble in ether. It is a strong acid which easily forms salts, including explosive ones. It is not decomposed by boiling water, even in the presence of alkalis, but it is liable to destructive distillation yielding dimethylnitramine $(\text{CH}_3)_2\text{N}\cdot\text{NO}_2$, m.p. 57°C, methyl alcohol, nitrous oxide and many other products.

Methylnitramine decomposes explosively in contact with concentrated sulphuric acid. It is evolved when aniline reacts with tetryl, a diphenylamine derivative (p. 51) is produced simultaneously. Methylnitramine reacts with picryl chloride to form tetryl. The structure of tetryl (p. 40) was first proved by this synthesis.

METHYLENEDINITRAMINE

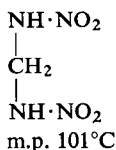

This substance was isolated in the form of its barium salt by Hirst *et al.* [12] when investigating the nitration of hexamethylenetetramine to cyclonite. They found that hexamethylenetetramine, when dissolved in nitric acid at 40°C , yields the product (II) which is hydrolysed by barium hydroxide to form the barium salt of methylenedinitramine. From this the free nitramine may be obtained:

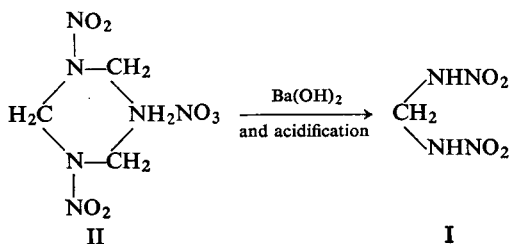

Brian and Lambertson [13] accomplished the synthesis of methylenedinitramine with methylene-bis-N-acetamide (III):

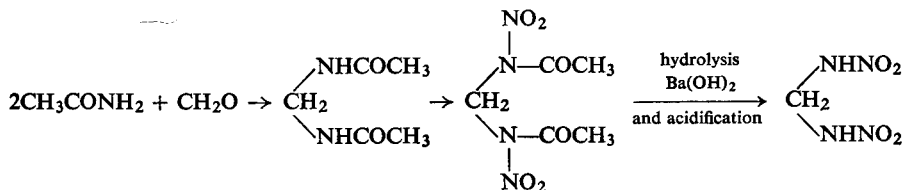

This synthesis served as a basis for the confirmation of the structure of methylenedinitramine.

Methylenedinitramine undergoes decomposition under the influence of strong acids and strong bases. At a pH of about 1.0 and 10.0, however, it is fairly stable although it decomposes readily when the pH ranges between 3 and 8, the maximum of the decomposition rate occurring at pH 5.4 (Lamberton *et al.* [14]). Decomposition is accompanied by the evolution of nitrous oxide and formaldehyde.

The methylenedinitramine homologues with the general formula:

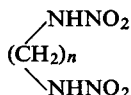

are far more stable.

Traube [15] prepared methylenedi-isonitramine, the isomer of methylenedinitramine, in the form of a sodium salt, by the action of nitric oxide on acetone, in the pres-

ence of sodium alcoholate. As T. Urbański *et al.* [16] showed, this substance can also be obtained by using paraldehyde instead of acetone. The structure of the isonitramino group has now been established as nitrosohydroxylamine. This substance and its salts, which according to T. Urbański *et al.* possess initiating properties, will be more fully described later (p. 221).

ETHYLENEDINITRAMINE

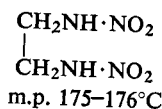

Franchimont and Klobbie [17] prepared ethylenedinitramine (EDNA, Haleite) by the nitration of ethylene urea (2-imidazolidone) with a mixture of nitric and sulphuric acids. (According to Schweitzer [18], ethylene urea is obtainable either by the action of urea on ethylenediamine at 110°C (initially) to 240–250°C (finally) in quantitative yield or by the action of urea on ethylene glycol at 160–240°C in 55% yield. W. E. Bachmann *et al.* [19] prepared ethylene urea by the action of ethyl carbonate on ethylenediamine in approximately 60% yield.) Hydrolysis of the dinitroethylene urea so formed gives ethylenedinitramine. Bachmann recommends nitration with mixed nitric acid and acetic anhydride:

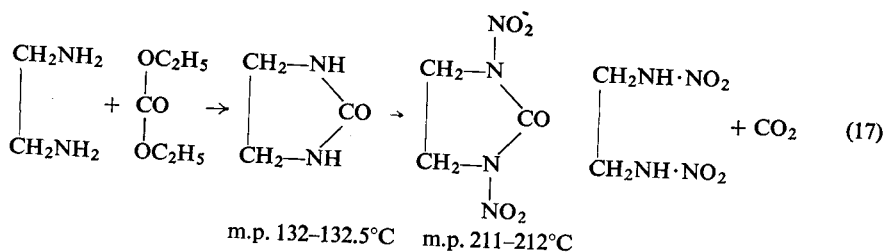

Dinitroethylene urea is highly unstable and readily hydrolysable by heating in water.

Another method of preparing ethylenedinitramine (also by Franchimont and Klobbie [17]), involves the action of chloroformate on ethylenediamine and nitration with nitric acid alone (98%). Bis-urethan after nitration is hydrolysed with ammonia solution (approximately 14%) at about 90°C:

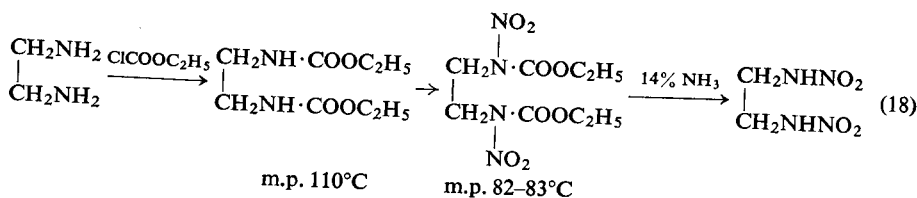

According to W. E. Bachmann *et al.* [19] the second of these methods gives a better yield (87% calculated in relation to the ethylenediamine used).

They found that a good yield of ethylenedinitramine may also be obtained from ethylenediamine through diacetyethylenediamine (ethylene-bis-acetamide). The nitration of the latter involves the use of nitric acid (98%) mixed with acetic anhydride:

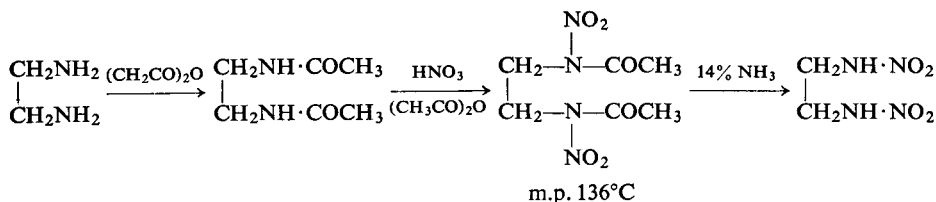

It is important to bear in mind that ethylene-bis-acetamide (earlier prepared by A. W. Hofmann [20]) cannot be nitrated with nitric acid alone or nitric and sulphuric acids. The product of nitration is readily hydrolysed by the action of 30% NaOH solution or *ca.* 15% NH₃ solution at room temperature.

The same authors found that ethylenedinitramine may be obtained in a similar way by promoting the transient formation of ethylene oxamide from ethylenediamine and ethyl oxalate:

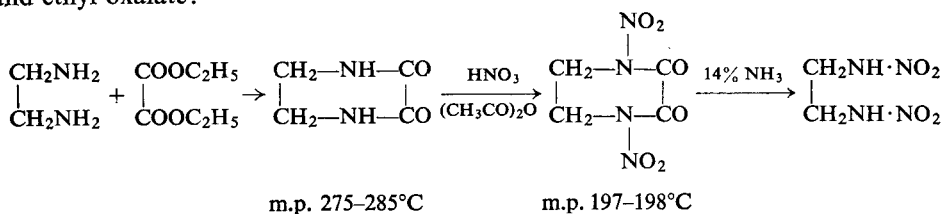

Ethylene oxamide was prepared earlier by van Alphen [21]. It cannot be nitrated either with nitric acid alone (98%) or with mixed nitric and sulphuric acids.

Ethylenedinitramine is produced on a technical scale in the following way:

One part of ethylene urea is introduced at a temperature not higher than 10°C into ten parts of a mixture consisting of:

HNO ₃	15.4%
H ₂ SO ₄	74.0%
H ₂ O	10.6%

After the last portion of ethylene urea has been added, the solution is poured into ice water. The nitroethylene urea thus precipitated is filtered, carefully washed and thrown into boiling water. On hydrolysis carbon dioxide is evolved. Boiling is continued until all the gases have been removed, and then the solution is cooled down. Ethylenedinitramine crystallizes in the rhombic system as white, lustrous crystals, *s.g.* 1.75 which after filtration are washed with cold water and dried at 50°C.

Hale [22] recommended ethylenedinitramine for use as a high explosive. It is insoluble in ether, but soluble in nitrobenzene and dioxane. The solubility of ethylenedinitramine is given in Table 1.

Ethylenedinitramine is non-hygroscopic and picks up only 0.01% of moisture in damp conditions at room temperature. It is a strong acid and easily forms salts. The

potassium salt can be recrystallized from alcohol. The silver and lead salts are highly sensitive to impact (they have a sensitiveness similar to that of mercury fulminate), but have no initiating properties. Ethylenedinitramine is not explicitly toxic.

TABLE 1
SOLUBILITY OF ETHYLENEDINITRAMINE

Temperature °C	Solubility in 100 g of	
	water	95% alcohol
25	0.3	1.25
50	1.25	3.45
75	4.95	10.1
95	16.4	—

Its chemical stability is fairly high and only an insignificant amount decomposes on prolonged boiling in water. Boiling in dilute sulphuric acid causes decomposition with the evolution of nitrous oxide, acetaldehyde and ethylene glycol.

Hale [22] reports that the ignition temperature of ethylenedinitramine is 180°C, i.e. similar to that of nitroglycerine. On heating at 120°C its stability is of the order of that of tetryl.

Ethylenedinitramine is a powerful explosive:

Heat of explosion	1267 kcal/kg
Volume of gases (V_0)	908 l./kg
Rate of detonation at a density of 1.55	7750 m/sec

A. J. B. Robertson [23] found that under a pressure of 100 mm of nitrogen at 174–178°C the thermal decomposition of EDNA is a first order reaction. The activation energy is 30.5 kcal and $\log B = 12.8$.

The substance possesses quite uncommon and valuable explosive properties. It is more powerful than tetryl, and considerably less sensitive to impact (as sensitive as picric acid). However, its acidic properties limit its use to a great extent. In this respect it resembles picric acid. Even so ethylenedinitramine, under the name of Haleite, has been accepted in the United States as a military explosive. During World War II, production in that country was carried out by the method outlined above according to eqn. (17)

OTHER NITRAMINES DERIVING FROM ETHYLENEDIAMINE

A series of new nitramines, the ethylenediamine derivatives, was prepared by Picard and Meen [24] by the action of acetone cyanohydrin on ethylenediamine and its analogues (i.e. diethylenetriamine etc.), followed by the nitration of the products.

obtained with mixed nitric acid and acetic anhydride. In the presence of CH_3COCl or HCl or ZnCl_2 , nitration gives yields as high as 76%. The simplest example of these compounds is the product (II), prepared by the following steps:

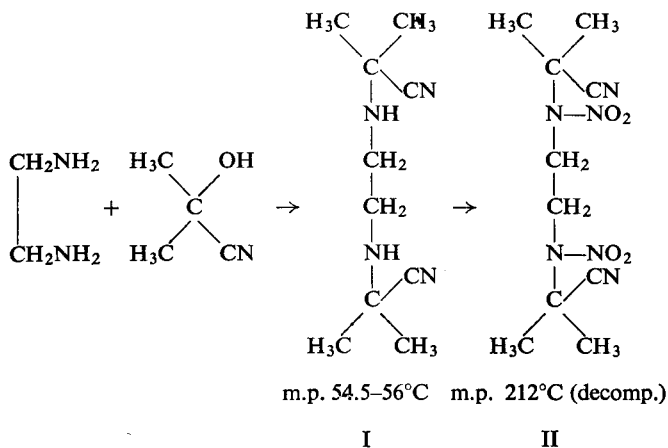

Higher homologues of ethylenedinitramine

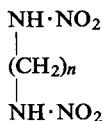

are crystalline substances with the following melting points:

	m.p.
at $n=3$	69°C
$n=4$	163°C
$n=5$	60°C

The explosive properties of these compounds have not been examined.

NITROCYANAMIDE

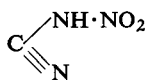

m.p. 137–138°C

Harris [25] isolated this substance by the action of anhydrous hydrogen chloride on the solution of the silver salt of nitrocyuanamide in acetonitrile. It has explosive properties but it is of no practical value due to the difficulty of preparing it. On the other hand its salts may be of practical value. These salts and their preparation will be discussed in the chapters dealing with initiating explosives (p. 211).

NITROGUANIDINE

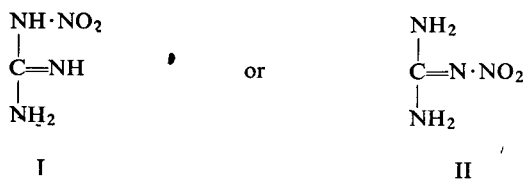

(tautomeric forms)
m.p. 232°C and 257°C

Jousselin [26] prepared nitroguanidine by the action of anhydrous nitric acid or sulphuric acid on guanidine nitrate. The preparation of this substance by the action of sulphuric acid has been developed as an industrial method for the production of nitroguanidine. The method described by Marqueyrol and Loriette [27] follows somewhat different principles. It consists in acting with anhydrous nitric acid on guanidine sulphate which, in turn, is obtained on treating dicyandiamide with sulphuric acid.

Attention has been focussed on the explosive properties of nitroguanidine since the beginning of the present century. Proposals were made for its use as a component of various high explosive mixtures, e.g. fusible ternary mixtures containing ammonium nitrate and guanidine nitrate (Albit) apart from using nitroguanidine itself. Before World War I, detonating fuses filled with nitroguanidine were used in French mines.

As a high explosive nitroguanidine had limited application until World War II, when it acquired a considerable significance owing to the fact that flashless and relatively non-erosive powders containing nitroguanidine, nitrocellulose, nitroglycerine and nitrodiethyleneglycol, were employed very widely. As early as 1901 Vieille [28] pointed out the negligible erosive properties of nitroguanidine as a component of propellant powders. Since that time interest in this substance as a component of propellant explosives has continued to increase. At first, however, nitroguanidine found no practical application since it cannot form a solution with the colloidal propellant and because it remains "foreign" to this colloid it makes the propellant brittle. This is particularly evident in nitrocellulose propellants. Recchi [29], however, called attention to the fact that the incorporation of nitroguanidine into a totally colloidal nitroglycerine propellant is possible without much detriment to its elasticity and mechanical strength. His idea was put into practice when: (1) the production of nitroguanidine from atmospheric nitrogen, starting from cyanamide, was developed and (2) nitrodiethyleneglycol came into use as a component of totally colloidal "double base" propellants, these being notable for their greater elasticity and mechanical strength as compared with propellants containing nitroglycerine.

PHYSICAL PROPERTIES

Nitroguanidine exists in two crystalline forms. The α -form results from the action of sulphuric acid on guanidine nitrate followed by the precipitation of the product with water. This form crystallizes from water in long, fairly flexible needles.

The β -form is produced either alone or together with some of the α -compound, by the nitration of the mixture of guanidine sulphate and ammonium sulphate which results from the action of sulphuric acid on dicyandiamide. The β -form crystallizes from water in thin, elongated plates. It is converted into the α -compound by solution in sulphuric acid and precipitation with water. Both forms of nitroguanidine melt at the same temperature. Several authors quote different melting points: 232, 246, 257°C.

The two forms appear to differ slightly in their solubility in water, neither form being converted into the other. At 25 and 100°C the solubility of the α -form is 4.4 g/l. and 82.5 g/l. respectively. Between these temperatures the β -form appears to be more soluble.

The problem of preparing nitroguanidine in finely powdered form is of great importance, since this is the only form suitable for incorporation into colloidal propellants (nitroglycerine or nitrodiethyleneglycol powders). Rapid cooling of the aqueous solution of nitroguanidine produces very small crystals, but they are still too coarse for use as a component in propellants. The desired fine powder may be obtained by spraying hot nitroguanidine solution onto a cooled, metallic surface, by allowing the spray to drop through a tower in counter current to a stream of cold air and finally, by allowing the product to crystallize from solutions containing substances which regulate the size of the crystals as they are formed.

Pritchard and Wright [30] have described their method for preparing fine-crystalline, free-flowing nitroguanidine. They prepared a hot aqueous saturated nitroguanidine solution which was poured into cold methanol. Ninety per cent of the nitroguanidine precipitated in fine crystals. From the solution containing 10% of nitroguanidine, methanol was distilled off. The remaining aqueous solution was used again for dissolving nitroguanidine. The best ratio (by volume) of water to methanol lies between 1 : 2 and 1 : 1.

The apparent density of the crystals is 0.96, whereas that of ordinary commercial nitroguanidine is about 0.25 and that of the product rapidly crystallized from methanol is about 0.40.

The solubility of nitroguanidine in organic solvents is limited. Desvergnès [31] determined its solubility in various solvents: water, acetone, methyl and ethyl alcohols, ethyl acetate, ether, benzene, toluene, pyridine, chloroform, carbon tetrachloride and carbon sulphide. In all these liquids the solubility of nitroguanidine is negligible, the highest value—for pyridine—being 1.75 g/100 ml at 19°C.

According to Pritchard and Wright 1 part of nitroguanidine is dissolved in 11 parts of water at boiling point and in 375 parts of water at 20°C. The greatest increase of solubility lies between 90 and 100°C.

Nitroguanidine dissolves in concentrated acids yielding labile salts. Its solubility in sulphuric acid has been reported by Davis [32] (see Table 2).

TABLE 2
SOLUBILITY OF NITROGUANIDINE IN SULPHURIC ACID

Concentration of sulphuric acid %	Solubility of nitroguanidine in 100 ml of acid	
	at 0°C	at 25°C
45	5.8	10.9
40	3.4	8.0
35	2.0	5.2
30	1.3	2.9
25	0.75	1.8
20	0.45	1.05
15	0.30	0.55
0	0.12	0.42

T. Urbański and Skrzynecki [33] examined a number of systems containing nitroguanidine and found the following binary and ternary eutectic mixtures—Table 3.

TABLE 3
EUTECTIC MIXTURES WITH NITROGUANIDINE

Components	Content of nitroguanidine in eutectic %	Freezing point of eutectic °C
Nitroguanidine + ammonium nitrate	20	131.5
Nitroguanidine + guanidine nitrate	41	166.5
Nitroguanidine + guanidine nitrate + ammonium nitrate	17.5 and 22.5 of guanidine nitrate	113.2

The ultra-violet absorption spectrum of nitroguanidine was first examined by Baly and Desch [34]. Figure 4 shows a curve plotted according to the investigations of R. N. Jones and Thorn [35]. In a neutral solution with an aqueous solvent the curve shows two maxima at about 210 and 265 μ . The absorption curve is unaffected by the addition of hydrochloric acid but under the influence of 1N NaOH solution the two maxima are converted into one, at about 250 μ . These changes may be caused by the tautomeric modifications of nitroguanidine. However, McKay,

Picard and Brunet [36] suggest that nitroguanidine may be a resonance hybrid. The structure of nitroguanidine will be discussed later. In the infra-red, nitroguanidine gives an absorption band of asymmetric vibrations of the NO_2 group which

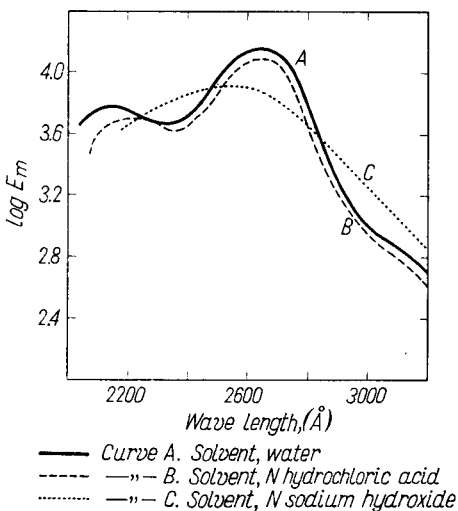

FIG. 4. Spectrum of nitroguanidine, according to R. N. Jones and Thorn [35].

deviates considerably from the average values of the NO_2 group in nitramines (approximately 1635 cm^{-1} instead of normal value 1560 cm^{-1}). The existence of tautomeric forms may explain this deviation (Bellamy [37]).

CHEMICAL PROPERTIES

Jousselin [26] wrongly ascribed to nitroguanidine the formula of an N-nitroso compound. Later Pelizzari [38], Franchimont [39] and Thiele [40] considered it to be nitramine. Franchimont proposed a nitroimine structure (II) (p. 22) and later Thiele deduced that it has the structural formula of a primary nitramine (I) (p. 22) by virtue of its ability to form salts. Much later, T. Urbański, Kapuściński and Wojciechowski [41] prepared the complex mercuric salt by the action of mercuric nitrate on an aqueous solution of nitroguanidine and examined its explosive properties. Nitroguanidine does not form salts with other metals. Later on Wright *et al.* [42, 43] once more expressed the opinion that nitroguanidine has the nitroimine structure (II) taking the form of nitramine only when influenced by alkalis. This new structure was based on the fact that unaltered nitroguanidine is precipitated from solution in concentrated alkalis, not a nitroguanidine salt. Similarly according to these authors potentiometric titration of freshly-prepared nitroguanidine solution in alkalis is indicative of a lack of acidic function. This agrees with the well-known observation that metallic vessels containing nitroguanidine do not corrode. Moreover,

Wright, Barton and Hall [42] found, that on keeping a nitroguanidine solution for a long time (10–20 hr) in dilute alkalis (0.1 *N* solution of NaOH) under reduced pressure in order to remove volatile by-products, such as ammonia, potentiometric titration demonstrates that the dissolved substance behaves as an acid. According to the authors, this is caused by the conversion of the nitroimine form (II) into the nitramine form (I) under the influence of an alkaline medium. Later Kirkwood and Wright [44] and Kumler and Sah [45] came to the conclusion, on the basis of dipole moment measurements, that nitroguanidine has the structure of a nitroimine or forms a resonance hybrid. This view was also confirmed by de Vries and Gantz [46]. On examining the absorption spectrum in the infra-red, Kumler [47] found that a hydrogen bond occurs in nitroguanidine and in a series of its derivatives:

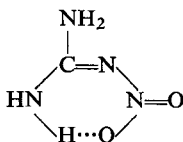

Nitroguanidine has weakly basic properties and this accounts for its ability to form salts with concentrated acids, e.g. it forms a sulphate with concentrated sulphuric acid. Nitroguanidine is hydrolysed on heating with concentrated sulphuric acid evolving nitrous oxide and carbon dioxide, the former probably derived from hydrolysis of nitramine and the latter from hydrolysis of cyanamide. The latter also yields ammonia on decomposition.

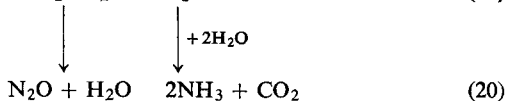
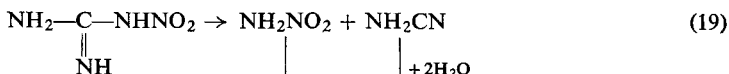

A solution of nitroguanidine in concentrated sulphuric acid also undergoes hydrolysis after standing for some time at room temperature. Then when diluted with water it no longer gives a precipitate of nitroguanidine.

A freshly prepared solution of nitroguanidine in sulphuric acid contains no free nitric acid, but in the presence of substances which are readily nitrated it behaves as if this were so, e.g. the solution nitrates phenol, acetanilide and cinnamic acid and in the presence of mercury reacts in a nitrometer with the evolution of nitric oxide in the same way as nitric acid. Hence in certain cases a solution of nitroguanidine in sulphuric acid may be utilized as a nitrating mixture.

One explanation is that in the presence of these substances nitramine is hydrolysed to form nitric acid [48].



Another, more recent explanation, ascribes to nitroguanidine the ability to liberate the NO_2^\ominus ion under the influence of sulphuric acid [48].

The decomposition of nitroguanidine by the action of ammonia in aqueous solution also proceeds according to equations (19) and (20).

Barton, Hall and Wright [42] found that the action of alkalis on nitroguanidine involves hydrolysis with the formation of ammonia, nitrourea and the products of the decomposition of nitrourea.

Nitroguanidine demonstrates high stability in aqueous solution on boiling, but on long-continued boiling evolves small amounts of ammonia, possibly due to decomposition according to equation (22):

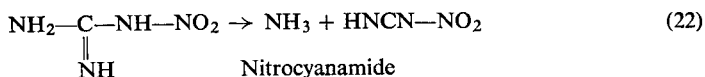

The ammonia so formed causes the decomposition of the nitramine that results from reaction (19).

According to equation (19) decomposition also occurs on boiling nitroguanidine in an aqueous solution of ammonium carbonate, with liberation of nitrous oxide and ammonia. The latter combines with the cyanamide also resulting from reaction (19) and guanidine carbonate is formed in almost quantitative yield.

In the presence of primary aliphatic amines in aqueous solution nitroguanidine undergoes decomposition according to equation (22). Ammonia is then evolved, and nitroguanidine combines with the amine to form alkylnitroguanidine, e.g. N-methyl-N'-nitroguanidine:

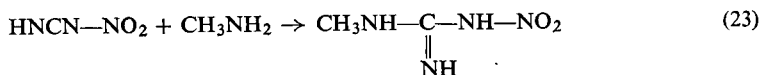

Wright and McKay [49] suggest a different reaction mechanism for the N-methyl-N'-nitroguanidine: in the first stage it involves the addition of methylamine to the nitroimine form of nitroguanidine, and this is followed by the liberation of ammonia and the formation of methylnitroguanidine (I).

Methylnitroguanidine so produced (I) is capable of further reaction with methylamine to yield dimethylguanidine (II).

These reactions may be characterized by the following mechanism (Wright [50]):

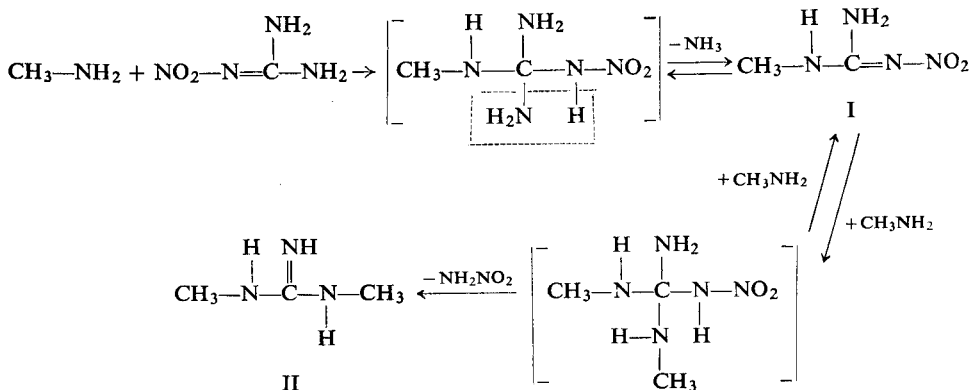

Dimethylguanidine is formed by the liberation of nitramine. The process is irreversible.

The structure of this substance was proved by the facility with which it can be hydrolysed to amine and nitrous oxide (24):

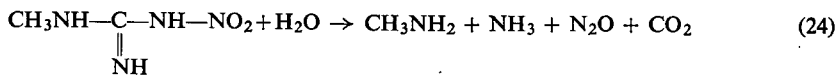

The reaction (24) indicates that the alkyl and nitro groups in N-alkyl-N'-nitroguanidine are linked with different nitrogen atoms.

The same N-alkyl-N'-nitroguanidines are obtainable by the nitration of alkylguanidines (Davis and Elderfield [51]).

With diamines such as ethylenediamine, addition to nitroguanidine leads only to the evolution of ammonia, so that the course of reaction is somewhat different. This will be considered later.

When heated with an aqueous solution of hydrazine (reaction (25)) nitroguanidine yields N-amino-N'-nitroguanidine (II) (Philips and Williams [52]), a white, crystalline substance of marked explosive properties, m.p. 182°C:

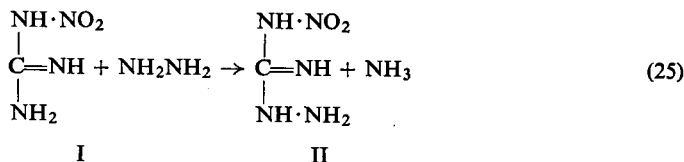

The substance (II) is converted by the action of nitrous acid into nitroguanily azide (IIa) at 0°C or into nitraminetetrazole (IIb) (Lieber *et al.* [53]) at 70°C. Both substances are explosive:

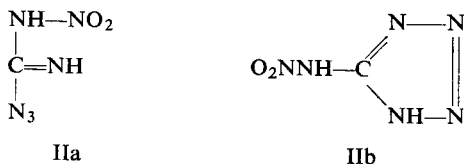

Under the influence of diamines, such as ethylenediamine, nitroguanidine yields cyclic compounds of type III with evolution of ammonia; they are liable to the further nitration through type (IV) up to cyclic nitramides of type (V) (McKay and Wright [54]).

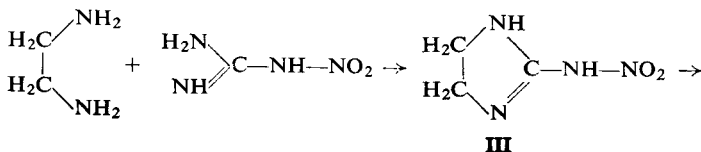

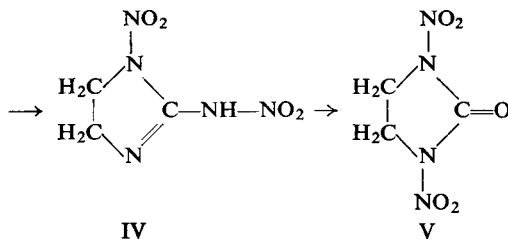

On reduction, nitroguanidine is converted first into nitrosoguanidine and then into aminoguanidine i.e. guanyldiazide. The latter is used for the manufacture of tetrazene (p. 206), and in organic chemistry to form crystalline derivatives from aldehydes and ketones, just as semicarbazide forms semicarbazones.

Nitroguanidine and nitrosoguanidine both give a blue colour with diphenylamine in concentrated sulphuric acid and both give the characteristic reactions described below:

(1) To an approximately 25% solution of nitroguanidine in cold water some drops of saturated ferric ammonium sulphate solution are added, then a 24% solution of NaOH. The filtered solution has a red colour resembling that of fuchsin.

(2) Nitroguanidine is dissolved in acetic acid, diluted to approximately 10%, treated with zinc dust in the cold, set aside for thirteen to nineteen minutes and filtered; 6% cupric sulphate solution is then added to the filtrate. The solution turns intensely blue and on boiling, becomes turbid, gives off gas and deposits a precipitate of metallic copper. If silver acetate is added instead of cupric sulphate a precipitate of metallic silver is deposited on boiling.

EXPLOSIVE PROPERTIES

Nitroguanidine decomposes immediately on melting, evolving ammonia and water vapour and forming solid products. According to Davis and Abrams [8], among the products resulting from the decomposition of nitroguanidine the following substances occur: nitrous oxide, cyanamide, melamine (from the polymerization of cyanamide), cyanic acid (from the decomposition of nitrocyanoamide), cyanuric acid (from the polymerization of cyanic acid), and ammeline (VI) and ammelide (VII) (from the co-polymerization of cyanic acid and cyanamide). The decomposition of the above substances involves the formation of carbon dioxide, urea, nitrogen, hydrogen cyanide, cyanogen and compounds not yet fully defined, such as melam, melem, and mellon probably containing condensed triazine rings.

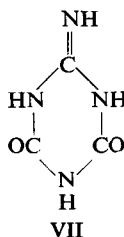
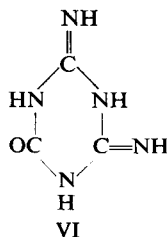

At a temperature below the melting point nitroguanidine is said to be relatively stable—more so than nitric esters and similar in stability to aromatic nitro compounds.

Attention has been paid to nitroguanidine as an explosive since Vieille [28] found that the gases from the decomposition of nitroguanidine are less erosive than those from the decomposition of other explosives of comparable power (Table 4).

TABLE 4
EXPLOSIVE PROPERTIES OF SUBSTANCES CONTAINING NITROGUANIDINE

Substance	Charge g	Pressure _v kg/cm ²	Erosion per g	Specific pressure <i>f</i> m
Nitroguanidine	3.90	2020	2.3	9000
Explosive gelatine	3.35	2460	31.4	10,000
Ballistite with addition of 57% nitroglycerine	3.55	2450	24.3	10,000
Nitrocellulose rifle propellant B ₇	3.55	2240	6.4	9600

Vieille expressed the opinion that nitroguanidine is less erosive than other explosives of the same power due to its low temperature of explosion. On the basis of experiments with a manometric bomb Patart [55] calculated the following data for nitroguanidine as an explosive:

temperature of explosion	907°C
covolume	1.60
specific pressure <i>f</i>	7140 m

Such a low temperature of explosion was very surprising and the author appears to have been in doubt as to its validity. Indeed, Muraour and Aunis [56] have shown that the temperature of explosion of nitroguanidine may, in fact, be much higher. They pointed out that nitroguanidine ignites with difficulty and undergoes incomplete explosive decomposition. That is why the explosion temperature, as reported by Patart, is so low.

Taking into account the results of experiments conducted with a manometric bomb as well as the chemical composition and specific heat of the products of decomposition Muraour and Aunis calculated the following values for the explosion of nitroguanidine:

temperature of explosion	2098°C
covolume	1.077
specific pressure <i>f</i>	9660 m

Urbański and Kapuściński [57] found the following values for the explosive properties of nitroguanidine (Tables 5 and 6).

TABLE 5

EFFECT OF THE COMPRESSION ON THE DENSITY OF NITROGUANIDINE

Pressure kg/cm ²	Density of loading
220	1.18
345	1.28
695	1.40
1040	1.48
1385	1.52
1730	1.57
2080	1.61
2775	1.65
3465	1.69
4160	1.71
4855	1.75

TABLE 6

RATE OF DETONATION OF NITROGUANIDINE

Density of loading	Rate of detonation in an iron pipe 27/34 mm dia.
0.80	4695
0.95	5520
1.05	6150
1.10	6440
1.20	6775
1.30	6195
1.40	3300
1.45	2640
—	—
—	—
—	—

Cook [58] reports the rate of detonation to be 5460 m/sec at a density of 1.0.

Nitroguanidine may be regarded as an explosive which is powerful, but difficult to detonate. This accounts for the considerable fall in the rate of detonation under increased density of loading. The diameter of loading also exerts a great influence on the rate of detonation, behaviour which is also characteristic of explosives which detonate with difficulty. An explosive of density 0.95 in a pipe of 20 mm inner diameter gave a rate of detonation of 4340 m/sec.

According to T. Urbański, Kapuściński and Wojciechowski [41] the silver and mercuric complex salts of nitroguanidine are more sensitive to impact than nitroguanidine itself, e.g., a weight of more than 10 kg must fall 100 cm to explode nitroguanidine, but the mercuric salt detonates when struck by a 10 kg weight falling only 12.5 cm.

THE PREPARATION OF NITROGUANIDINE

Bourjol [59] reviewed various methods of preparing nitroguanidine from guanidine nitrate and sulphuric acid, and also carried out extensive experiments to find the most convenient laboratory method of carrying out the reaction.

The main features of the reaction, according to Bourjol are:

(1) The rate of reaction depends on the ratio $\text{H}_2\text{SO}_4 : (\text{H}_2\text{SO}_4 + \text{H}_2\text{O})$. The higher the ratio the faster the reaction. The rate is considerably reduced when the concentration of sulphuric acid falls to 82% H_2SO_4 , and the reaction practically stops at 79–80% H_2SO_4 . The concentration at the beginning and the end should be 94–95% and 85–88% respectively.

(2) The rate of reaction depends on the size of the guanidine nitrate crystals. It is strongly advisable to grind the guanidine nitrate before introducing it into the sulphuric acid.

(3) It is advisable to use enough sulphuric acid to dissolve the guanidine nitrate completely.

(4) The temperature during the reaction should be kept below 30°C. On the other hand, too low a temperature may not be advisable as the solubility of guanidine nitrate may be reduced and the reaction may be too slow. It is advisable to maintain a temperature of 20–25°C at the beginning of the reaction and to raise it at the end to 35–40°C, but not higher.

(5) The reaction solution should be diluted to 15% H₂SO₄ keeping the temperature below 30°C to ensure full precipitation of the nitroguanidine. The product should be washed with an aqueous solution of ammonium carbonate and then with water at 15–25°C.

According to Bourjol the yield is 92.8%.

Cave, Krottinger and McCaleb [60] worked out a general method for preparing explosives in the form of fine crystals. It consists of introducing a hot solution into a cold diluting liquid.

In the case of nitroguanidine, a hot aqueous solution was introduced into cold methanol. Still finer and more uniform crystals were prepared by introducing a cold solution in n-butanol into carbon tetrachloride. The results are given in Table 7.

TABLE 7

Solvent	Diluting liquid	Average crystal size μ	Limits of the crystal size μ	Ratio (length) (width)
Water	Methanol	55	3–155	30
n-Butanol	Carbon tetra- chloride	1.5	0.2–4.0	11

The method of manufacturing nitroguanidine adopted in Germany during World War II consists of the addition of guanidine nitrate to a nitrator filled with 98% sulphuric acid, while the temperature is maintained below 45°C by cooling. The nitroguanidine sulphate is formed very rapidly and nitroguanidine is then precipitated by introducing the contents of the nitrator into a diluter containing water, the mother liquor and the wash water at 0°C. The suspension of nitroguanidine in 20% sulphuric acid is separated from the latter by centrifuging, washed with water and is centrifuged again to a 25% content of water.

Crude, acidic nitroguanidine is dissolved in a boiling mixture of water and the mother liquor from previous crystallization. To 1 part of nitroguanidine 14–16 parts of solvent are added. The solution is neutralized with ammonia, filtered and chilled by injecting the hot (approximately 100°C) solution into a vessel under reduced pressure: this results in lowering the temperature of the solution to 45°C. A crystalline

suspension of the product is formed and separated in a centrifuge. Thus nitroguanidine containing 6% of water is obtained. The mother liquor is returned for re-use.

Nitroguanidine occurs in a fine-crystalline form in which it is suitable for the manufacture of flashless propellant. A different form of nitroguanidine is used as a high explosive. When it is to be compressed, its solution is rapidly evaporated under reduced pressure to form a specially fine-crystalline product.

Nitroguanidine intended for use in a fusible mixture with trinitrotoluene takes the form of fairly large, very regular crystals. For this purpose a colloidal substance is added to the nitroguanidine solution, which is allowed to crystallize slowly.

In the method outlined above 136 kg of guanidine nitrate and 300 kg of 98% sulphuric acid are used to produce 100 kg of nitroguanidine.

Another method of nitroguanidine preparation is that of Marquoyrol and Lorient mentioned already [27]. According to Aubertein [61], here nitroguanidine is formed by the following reactions: dicyandiamide is heated with 60% sulphuric acid at 150°C to form guanidine sulphate which however is not isolated. Instead, the reaction mixture is treated directly with a 30% excess of anhydrous nitric acid at 25°C. Nitroguanidine, m.p. 257°C, is prepared in this manner in a 91% yield.

NITROUREA

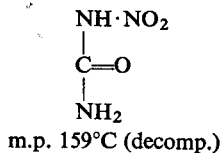

Nitrourea, like nitroguanidine, is prepared by the action of sulphuric acid on urea nitrate. It was recommended as an explosive by Badische Anilin und Soda-Fabrik in 1915 [62] but without success, as it was not sufficiently stable. In the presence of water it decomposes at a little above 60°C with the evolution of nitrous oxide.

Davis and Blanchard [7] found that an aqueous solution of nitrourea or its solution in concentrated sulphuric acid is hydrolysed to nitramine and cyanic acid according to the equation:

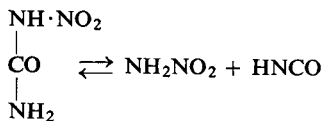

The reaction is reversible since nitramine in aqueous solution combines with cyanic acid to reform nitrourea. Nitrourea is decomposed by gaseous ammonia, a reaction which, according to Watt and Makosky [63] proceeds as follows:



The cyanic acid can react with ammonia to produce ammeline (I) and ammeline (II):

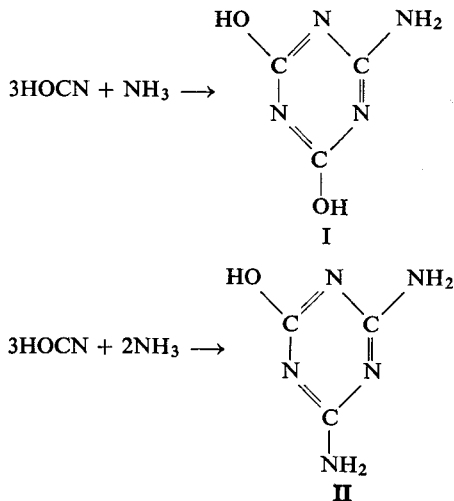

In addition, a polymer with the empirical formula $(\text{C}_5\text{H}_{11}\text{O}_5\text{N}_7)_n$ is produced.

Reaction with liquid ammonia at -33°C probably proceeds in a manner similar to that described by Davis and Blanchard: it is believed that nitramine (decomposing into N_2O and water) and urea (apparently from cyanic acid and ammonia) are formed.

The action of ammonia on nitrourea does not lead to the formation of nitroguanidine.

Urbański, Kapuściński and Wojciechowski [41] showed that nitrourea is a more powerful explosive than nitroguanidine. Its lead block expansion is 310 cm^3 .

As a primary nitramine, nitrourea can form salts. The potassium, silver, mercuric (Thiele and Lachman [64]) and ammonium (Hantzsch and Wiegner [65]) salts are described in the literature.

T. Urbański *et al.* [41] found that the silver and mercuric salts are much more sensitive to impact than nitrourea itself, but have no initiating properties.

OTHER ALIPHATIC NITRAMINES

DINITRODIMETHYLOXAMIDE (MNO)

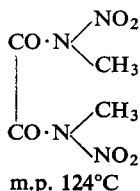

This substance was prepared by Franchimont [66] by the action of anhydrous

nitric acid on N-dimethyloxamide. The latter is obtained readily by the interaction of methylamine with methyl or ethyl oxalate:

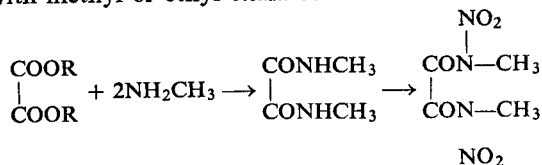

The product of nitration of dimethyloxamide is soluble in nitric acid and is separated by pouring the solution into water. It decomposes on treatment with concentrated sulphuric acid or on boiling with aqueous ammonia or barium hydroxide solution, forming the corresponding methylnitramine salt. Similarly, long-continued boiling in water results in complete decomposition, with the formation of oxalic acid and methylnitramine.

In spite of being hydrolysed so readily its chemical stability is exceptionally high. Haid, Becker and Dittmar [67] report that dinitrodimehyloxamide, like trinitrotoluene, tetryl and penthrite, does not evolve oxides of nitrogen on being heated at 100°C for 30 days.

T. Urbański [68] found the substance to be only slightly sensitive to impact: it does not explode under the impact of a 5 kg weight falling 90 cm. The rate of detonation of dinitrodimehyloxamide was determined by T. Urbański in a tin plate tube 21 mm dia.:

density 0.87	6500 m/sec
density 1.22	6440 m/sec
density 1.33	7130 m/sec

The lead block expansion was 370 cm³.

T. Urbański examined the possibility of mixing this substance with penthrite (PETN) and picric acid to lower the melting points of these explosives.

Dinitrodimehyloxamide forms eutectic mixtures with penthrite and picric acid, as follows:

with 37% penthrite	m.p. 100.5°C
with 45% picric acid	m.p. 78.6°C

DINITRODIETHYLOXAMIDE

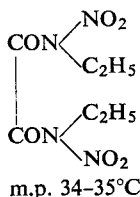

In general this substance has the same chemical properties as its dimethyl homologue, described above. It is a weaker explosive than the dimethyl derivative and shows only slight sensitiveness to impact (less than trinitrotoluene). It gives a lead block expansion of 220 cm³.

DINITRODIMETHYLSULPHAMIDE

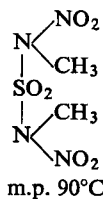

This substance was prepared by Franchimont [69] from dimethylsulphamide obtained by the interaction of methylamine and sulphuryl chloride:

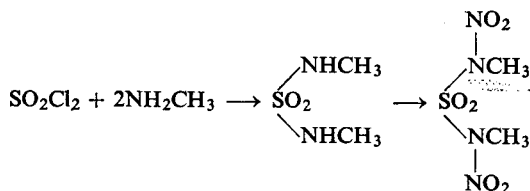

The nitration is carried out with a large excess of anhydrous nitric acid (10 parts of acid to 1 part of sulphamide). The product is precipitated by pouring the nitric acid solution into water.

It dissolves with difficulty in water, moderately well in chloroform and benzene, and readily in hot alcohol. Its ignition temperature is 160°C .

It is a very powerful explosive, as reported by Naoúm and Meyer [70]. It gives a lead block expansion of 395 cm^3 , i.e. similar to that of tetryl, but has the disadvantage of being highly sensitive to impact.

NITRODIETHANOLAMINE DINITRATE (DINA)

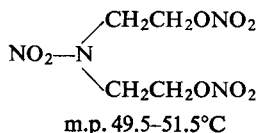

In the inter-war period a certain interest was taken in the nitric esters of amino and amido alcohols. The simplest of these was the product of nitration of diethanolamine, i.e. nitrodiethanolamine dinitrate.

The method of preparation was described by Wright, Chute, Herring and Toombs [71]. They treated diethanolamine with a mixture of nitric acid and acetic anhydride in the presence of hydrogen chloride as a catalyst. Instead of hydrogen chloride, its salts such as zinc chloride may be used. The yield amounts to 90%, but is much lower without a catalyst.

The substance is a very powerful explosive, similar to nitroglycerine in this respect. It is capable of gelatinizing nitrocellulose and hence can be used instead of nitroglycerine in propellants.

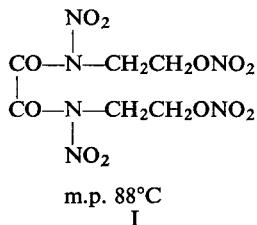
DINITRODI-(β -HYDROXYETHYL)-OXAMIDE DINITRATE (NENO)

This substance was prepared by Herz [72] who recommended it as an explosive. It is obtainable from oxalic ester by the following reactions:



In explosive power, it occupies an intermediate position between penthrite and tetryl. Its lead block expansion is 450 cm³.

According to Domański and Mieszkis [73] the rate of detonation, at a density of loading of 0.93 in a paper tube 10 mm dia., is 5200 m/sec (under the same conditions the rate of detonation of penthrite was approximately 6000 m/sec). Cook [58] found the rate of detonation to be 5530 m/sec at a density of loading of 1.0. The substance is similar to tetryl in sensitiveness to impact. Its chemical stability is slightly less than that of tetryl. Its ignition temperature ranges from 165 to 170°C.

In spite of many advantages, this substance has not achieved practical application due to its high cost.

DINITRODIMETHYLDIAMIDE OF TARTARIC DINITRATE

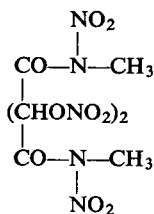

m.p. 114°C (decomp.)

T. Urbański [74] prepared this substance by the nitration of the dinitrodimethyldiamide of tartaric acid with a mixture of nitric acid and acetic anhydride at a temperature below -2°C . It is capable of gelatinizing nitrocellulose.

It is a very powerful explosive (the rate of detonation at a density of 0.80 in a cartridge 10 mm dia. is 4060 m/sec, and the lead block expansion is 390 cm³) but it is not sufficiently stable since its ignition temperature is only slightly above its melting point. It is also very sensitive to impact—like nitroglycerine.

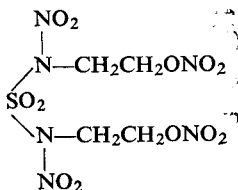
DINITRODI-(β -HYDROXYETHYL)-SULPHAMIDE DINITRATE

Herz [72] described the preparation of this substance by the action of ethanolamine on sulphuryl chloride, followed by the nitration of the dihydroxyethylsulphamide so obtained.

In explosive properties and explosive power it is similar to dinitrodi-(β -hydroxyethyl)-oxamide, described above.

LITERATURE

1. J. THIELE and A. LACHMAN, *Ann.* **288**, 267 (1895).
2. A. HANTZSCH, *Ann.* **292**, 340 (1896).
3. K. CLUSIUS, *Helv. Chim. Acta* **44**, 1149 (1961).
4. J. THIELE, *Ann.* **296**, 100 (1897).
5. C. A. MARLIES, V. K. LA MER and J. GREENSPAN, *Inorganic Synthesis*, Vol. I, p. 68, McGraw-Hill, New York, 1939.
6. R. P. BELL and G. L. WILSON, *Trans. Faraday Soc.* **46**, 407 (1950).
7. T. L. DAVIS and K. C. BLANCHARD, *J. Am. Chem. Soc.* **51**, 1790 (1929).
8. T. L. DAVIS and A. J. J. ABRAMS, *J. Am. Chem. Soc.* **47**, 1043 (1925); *Proc. Amer. Ac. Sci.* **61**, 437 (1926).
9. R. P. BELL and E. F. CALDIN, *Trans. Faraday Soc.* **47**, 50 (1952).
10. E. F. CALDIN and J. PEACOCK, *Trans. Faraday Soc.* **51**, 1217 (1955).
11. R. P. BELL, *Advances in Catalysis* **4**, p. 170, Interscience, New York, 1952.
12. E. L. HIRST *et al.*, according to A. H. LAMBERTON, *Quart. Rev.* **5**, 75 (1951).
13. R. C. BRIAN and A. H. LAMBERTON, *J. Chem. Soc.* **1949**, 1633.
14. A. H. LAMBERTON, C. LINDLEY and J. C. SPEAKMAN, *J. Chem. Soc.* **1949**, 1650.
15. W. TRAUBE, *Ann.* **300**, 81 (1898).
16. T. URBANSKI and J. ZACHAREWICZ, *Wiad. Techn. Uzbr.* **18**, 16 (1932); T. URBANSKI and T. WESOŁOWSKI, *ibid.* **18**, 28 (1932).
17. A. P. N. FRANCHIMONT and E. A. KLOBBIE, *Rec. trav. chim.* **5**, 280 (1886); **7**, 17, 239 (1888).
18. C. E. SCHWEITZER, *J. Org. Chem.* **15**, 471 (1950).
19. W. E. BACHMANN, W. J. HORTON, E. L. JENNER, N. W. MACNAUGHTON and C. E. MAXWELL, *J. Am. Chem. Soc.* **72**, 3132 (1950).
20. A. W. HOFMANN, *Ber.* **21**, 2333 (1888).
21. J. VAN ALPHEN, *Rec. trav. chim.* **54**, 937 (1935).
22. G. C. HALE, *J. Am. Chem. Soc.* **47**, 2754 (1925); U.S. Pat. 2011578 (1935).
23. A. J. B. ROBERTSON, *Trans. Faraday Soc.* **44**, 627 (1949).
24. J. P. PICARD and R. H. MEEN, *Can. J. Chem.* **30**, 102, (1952).
25. S. R. HARRIS, *J. Am. Chem. Soc.* **80**, 2302 (1958).
26. L. JOUSSELIN, *Compt. rend.* **85**, 548 (1877); **88**, 814, 1086 (1879); *Bull. soc. chim. France* [2], **30**, 186 (1878).
27. M. MARQUEYROL and P. LORIETTE, *Swiss Pat.* **87384** (1917).

28. P. VIEILLE, *Mém. poudres* **11**, 173 (1901).
29. V. RECCHI, *Z. ges. Schiess- u. Sprengstoffw.* **1**, 286 (1906); *VI Intern. Chem. Congress, Rome* **2**, 580 (1906).
30. E. J. PRITCHARD and G. F. WRIGHT, *Can. J. Research* **25 B**, 257 (1947).
31. L. DESVERGNES, *Mém. poudres* **19**, 217 (1922); *Chimie et industrie* **22**, 37 (1930).
32. T. L. DAVIS, *J. Am. Chem. Soc.* **44**, 868 (1922); *The Chemistry of Powder and Explosives*, J. Wiley, New York, 1943.
33. T. URBAŃSKI and J. SKRZYNECKI, *Roczniki Chem.* **16**, 353 (1936).
34. E. C. C. BALLY and C. M. DESCH, *J. Chem. Soc.* **93**, 1747 (1908).
35. R. N. JONES and G. D. THORN, *Can. J. Research* **27 B**, 828 (1949).
36. A. F. MCKAY, J. P. PICARD and P. E. BRUNET, *Can. J. Chem.* **29**, 746 (1951).
37. L. J. BELLAMY, *The Infra-red Spectra of Complex Molecules*, Methuen, London, 1958.
38. G. PELIZZARI, *Gazz. chim. ital.* **21**, II, 405 (1891).
39. A. P. N. FRANCHIMONT, *Rec. trav. chim.* **10**, 231 (1891); **13**, 308 (1894).
40. J. THIELE, *Ann.* **270**, 1 (1892).
41. T. URBAŃSKI, Z. KAPUŚCIŃSKI and W. WOJCIECHOWSKI, *Wiad. Techn. Uzbr.* **IV**, 35 (1935).
42. S. S. BARTON, R. H. HALL and G. F. WRIGHT, *J. Am. Chem. Soc.* **73**, 2201 (1951).
43. A. A. AMOS, P. D. COOPER, E. NISHIZAWA and G. F. WRIGHT, *Can. J. Chem.* **39**, 1787 (1961).
44. M. W. KIRKWOOD and G. F. WRIGHT, *J. Org. Chem.* **18**, 629 (1953).
45. W. D. KUMLER and P. P. T. SAH, *J. Org. Chem.* **18**, 669, 676 (1953).
46. J. H. DE VRIES and E. S. C. GANTZ, *J. Am. Chem. Soc.* **76**, 1008 (1954).
47. W. D. KUMLER, *J. Am. Chem. Soc.* **75**, 3092 (1953); **76**, 814 (1954).
48. T. URBAŃSKI, *Teoria nitrowania*, PWN, Warszawa, 1954.
49. A. F. MCKAY and G. F. WRIGHT, *J. Am. Chem. Soc.* **69**, 3028 (1947).
50. G. F. WRIGHT in H. GILMAN'S, *Organic Chemistry*, Vol. IV, p. 951, J. Wiley, New York, 1953.
51. T. L. DAVIS and R. C. ELDERFIELD, *J. Am. Chem. Soc.* **55**, 731 (1933).
52. R. PHILIPS and J. F. WILLIAMS, *J. Am. Chem. Soc.* **50**, 2465 (1928).
53. F. LIEBER, E. SHERMAN, R. A. HENRY and J. COHEN, *J. Am. Chem. Soc.* **73**, 2327 (1951); F. LIEBER, E. SHERMAN and S. H. PATINKIN, *ibid.* **73**, 2329 (1951).
54. A. F. MCKAY and G. F. WRIGHT, *J. Am. Chem. Soc.* **70**, 430 (1948).
55. G. PATART, *Mém. poudres* **13**, 153 (1905/6).
56. H. MURAOUR and G. AUNIS, *Mém. poudres* **25**, 91 (1932/33).
57. T. URBAŃSKI and Z. KAPUŚCIŃSKI, *Wiad. Techn. Uzbr.* **38**, 525 (1939).
58. M. A. COOK, *The Science of High Explosives*, Reinhold, New York, 1958.
59. G. BOURJOL, *Mém. poudres* **32**, 11 (1950).
60. G. A. CAVE, N. J. KROTINGER and J. D. MCCAULEB, *Ind. Eng. Chem.* **41**, 1286 (1949).
61. P. AUBERTEIN, *Mém. poudres* **30**, 143 (1948).
62. Badische Anilin u. Soda-Fabrik, Ger. Pat. 303929 (1915).
63. G. W. WATT and R. C. MAKOSKY, *Ind. Eng. Chem.* **46**, 2599 (1954).
64. J. THIELE and A. LACHMAN, *Ann.* **288**, 267 (1895).
65. A. HANTZSCH and G. WIEGNER, *Z. physik. Chem.* **61**, 485 (1908).
66. A. P. N. FRANCHIMONT, *Rec. trav. chim.* **2**, 96 (1883); **4**, 196 (1885); **13**, 308 (1894).
67. A. HAID, F. BECKER and P. DITTMAR, *Z. ges. Schiess- u. Sprengstoffw.* **30**, 66, 105 (1935).
68. T. URBAŃSKI, *Wiad. Techn. Uzbr.* **IV**, 3 (1935).
69. A. P. N. FRANCHIMONT, *Rec. trav. chim.* **2**, 96 (1883).
70. PH. NAOUËM and K. F. MEYER, Ger. Pat. 505852 (1929).
71. W. J. CHUTE, K. G. HERRING, L. E. TOOMBS and G. F. WRIGHT, *Can. J. Research* **26 B**, 89 (1948).
72. E. HERZ, Brit. Pat. 367713 (1932).
73. T. DOMAŃSKI and K. MIESZKIS, *Wiad. Techn. Uzbr.* **44**, 309 (1939).
74. T. URBAŃSKI, *Roczniki Chem.* **16**, 334 (1936).

CHAPTER III

AROMATIC NITRAMINES

TETRYL

THE key representative of aromatic nitramines is the trinitro derivative of phenylmethylnitramine—tetryl. This is 2,4,6-trinitrophenylmethylnitramine or picrylmethylnitramine or N-2,4,6-trinitro-N-methylaniline.

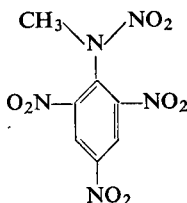

Tetryl is a widely-used explosive. It is also known under the names of Pyronite, Tetrylit, Tetralite, Tetralita. In England it has been known for some time as Composition Exploding—CE. The incorrect name—tetranitromethylaniline—may sometimes be encountered in the literature.

Tetryl, known since 1877, has been used as an explosive since 1906. During World War I because of its explosive power and sensitiveness to initiation it was employed in the filling of blasting caps and as a “priming” to fill detonating gains (boosters). It is still used for the same purpose, although to a much lesser extent since the introduction of PETN and cyclonite. During World War II tetryl was also utilized as a component of high explosive mixtures.

Mertens [1] was the first to obtain tetryl in 1877 by the action of fuming nitric acid on a dimethylaniline solution in sulphuric acid or by boiling a dinitrodimethylaniline solution in fuming nitric acid. Soon afterwards Michler *et al.* [2] prepared it by the action of fuming nitric acid on quaternary dimethylaniline salts. Neither of these authors gave the correct structure of the product. Romburgh [3] later explained more precisely the conditions of tetryl formation from methyl- and dimethylaniline. He also postulated and then proved its structure by synthesizing it from potassium methylnitramine and picryl chloride:

The last step (V) to (I) is reversible: if tetryl is dissolved in concentrated sulphuric acid and allowed to stand the N-nitro group is expelled and trinitromethylaniline (V) is formed (cf. p. 5).

The empirical equation for the preparation of tetryl from dimethylaniline is as follows:

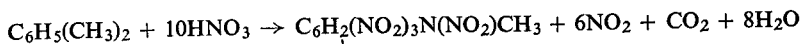

Hodgson and Turner [5] examined the action of various concentrations of nitric acid alone on dimethylaniline, by nitrating 5 g test specimens of the latter on a laboratory-scale.

They prepared tetryl by treating dimethylaniline with a 20-fold volume of nitric acid, s.g. 1.52 at -5 to 0°C .

They also obtained a lower-nitrated product by employing nitric acid, s.g. 1.42 at 0°C . Later authors (Clarkson, Holden and Malkin [4]) found that this product was N-2,4-trinitroethylaniline. At room temperature the reaction proceeds violently and decomposition with a tendency to explosion readily occurs in the nitrator. Nitric acid of lower concentrations, s.g. 1.34 and 1.254, gives 2,4-dimethylaniline at 0°C in quantitative yield. At a higher temperature they obtained a mixture of this compound with 2,4-dinitromethylaniline.

The oxidizing action of nitric acid predominates when a still lower concentration is used—specific gravity 1.12. In this case, originally described by Mertens [6] (who suggested a wrong structure) and fully described by Romburgh [7] 3,3',5,5'-tetranitrotetramethylbenzidine is formed as well as 2,4-dinitrodimehtylaniline. Nitric acid, s.g. 1.024 does not react with dimethylaniline, but in the presence of nitric oxides, or NaNO_2 , leads to the formation of *p*-nitrosodimehtylaniline.

Recently, T. Urbański and Semeńczuk [8] made it clear that tetryl may be safely prepared by nitrating dimethylaniline with nitric acid, s.g. 1.40. Essential safety precautions for the procedure are:

- (1) The use of a large excess of nitric acid

$$\left(\frac{\text{nitric acid}}{\text{dimethylaniline}} = \text{ca. } 40 \text{ by weight} \right)$$

- (2) The conduct of the reaction in two stages.

In the first stage dimethylaniline is dissolved in nitric acid, the temperature not being allowed to exceed 7°C . It is then gradually raised to 80°C . When the vigorous reaction has subsided, the mixture is heated at 90°C .

On cooling, the solution deposits crystals of tetryl. To obtain complete precipitation of the product, water may be added to the solution. The yield of tetryl is 78%.

The reaction can also be carried out by dissolving dimethylaniline first in an excess of nitric acid, s.g. 1.40 (e.g. in the weight ratio of nitric acid to dimethylaniline of approximately 15 : 1) then adding excess nitric acid, s.g. 1.50 to this solution, until the final weight ratio is approximately 25 : 1, finally proceeding as above. In this way tetryl, m.p. 129.5°C is obtained in approximately 83% yield.

This method is suitable for continuous operation in a series of small nitrators. A higher temperature is maintained in each successive nitrator, e.g. from 5 to 90°C. By thus dividing production among a large number of reactors, an acceptable degree of safety is achieved.

T. Urbański and Semeńczuk found that tetryl prepared with nitric acid alone is of high purity, possibly because it is not contaminated with 2,4,6-trinitro-N-methylaniline formed from tetryl as a result of the loss of the N-nitro group on heating with sulphuric acid, present in an ordinary nitrating mixture.

Developing their method further, Semeńczuk and T. Urbański [9] devised a way of nitrating dimethylaniline with nitric acid alone in the presence of an organic solvent inert to nitric acid. This has two advantages: by diluting nitric acid with a solvent, the course of the reaction is moderated; and by using a relatively low-boiling solvent, e.g. chloroform, a "thermostatic" medium is created, the upper temperature of which is limited by the boiling point of the solvent.

As early as 1938, Shorygin and Topchiyev [10] nitrated dimethylaniline with a solution of nitrogen dioxide in chloroform, but they were only able to obtain 4-nitrodimethylaniline with a small amount of 3-nitrodimethylaniline. No demethylation of the N-dimethylamino group occurred.

Semeńczuk and T. Urbański found that the following solvents may be used: dichloromethane, chloroform, carbon tetrachloride and tetrachloroethane. Their nitration method consisted of introducing a solution of dimethylaniline into fuming nitric acid diluted with the same solvent, maintaining a temperature of approximately 5°C. The mixture was then warmed cautiously to 40°C. On approaching this temperature, strong evolution of nitrogen dioxide occurred and the temperature rose. When chloroform or dichloromethane was used, the solvent distilled off at 61°C. The remaining solution, free from solvent, was warmed to 80°C until a light orange colour was established. When the reaction was complete, water was added to precipitate tetryl. The yield was high, 98% of theoretical and the purity of the product was very satisfactory, m.p. 129°C. When carbon tetrachloride was used, it was removed either by decantation or by distillation at about 77°C. Higher boiling solvents such as tetrachlorethane should be removed only by decantation, after which the acid layer should be diluted with water as described above.

Semeńczuk and T. Urbański also showed that dimethylaniline may be nitrated to tetryl by a mixture of nitric acid with acetic acid or acetic anhydride. As yet the only other results mentioned in the literature with reference to this method are those of Orton [11]. He asserted that dimethylaniline gives no N-nitro derivative when reacted with a mixture of nitric acid with acetic anhydride or acetic acid; he obtained only 2,4-dinitromethylaniline.

Semeńczuk and T. Urbański employed various proportions of nitric acid, s.g. 1.50, to acetic anhydride or acetic acid. The best results were obtained when the volume ratio was used

$$\frac{\text{nitric acid}}{\text{acetic anhydride or acetic acid}} = \frac{50}{50}$$

The spontaneous reaction which occurred after introducing dimethylaniline into the nitrating mixture caused the temperature to rise to about 40°C. After the reaction subsided, it was necessary to warm the reaction mixture and to keep it at 80°C until the reaction was complete.

Water was added to the cooled reaction solution and pure N-2,4,6-trinitromethylaniline precipitated. The yield was 90% of theoretical.

Thus, Orton's statement should be limited to the specific experimental conditions which he himself used.

NITRATION OF DINITROMETHYLANILINE

The conditions of nitration of dinitromethylaniline with nitric acid were recently studied by Lang [12]. He explained that in order to introduce the N-nitro group it is necessary to use nitric acid with a concentration of more than 70%. The nitration then proceeds as follows:

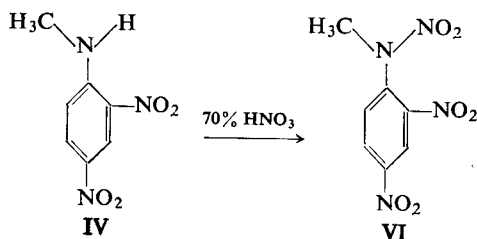

In the presence of nitrogen dioxide, the reaction proceeds differently, and the N-nitroso derivative is formed. When 99% nitric acid is used together with NO₂, a mixture of di- and trinitro nitroso derivative is produced, while 40% nitric acid gives only a dinitro derivative

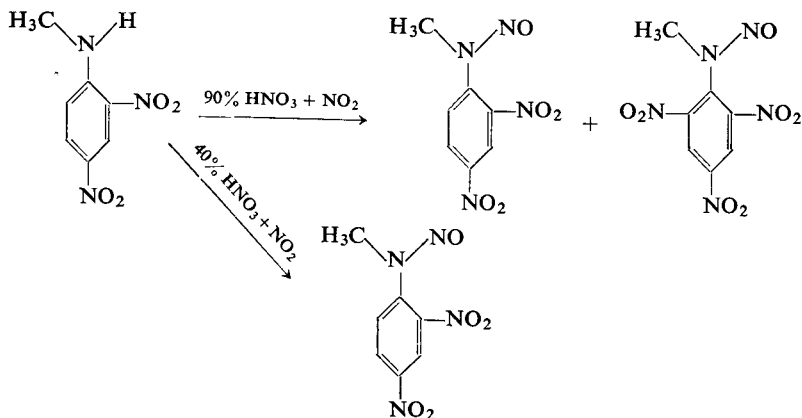

The nitration of 2,4-dinitromethylaniline to tetryl with nitric acid alone was also studied by Isoire and Burlet [13]. These authors found that nitration may be carried out by means of nitric acid, s.g. 1.44 (75% concentration) and over. When using nitric acid, s.g. 1.44–1.46 (75–80% concentrations) the temperature of nitra-

tion should be maintained above 70°C. The final temperature may be lower if the final concentration of acid in the nitrator is higher than 85%. For instance when using 95% nitric acid (s.g. 1.50) in such quantity that by the end of nitration the concentration is less than 85%, it is sufficient to maintain a temperature of 50°C during that latter period.

The authors obtained a quantitative precipitation of tetryl by diluting the contents of the nitrator to a 50–55% concentration of HNO₃. Tetryl is practically insoluble in such dilute acid hence the precipitation is quantitative.

Tetryl prepared in this way was contaminated by the following substances:

(1) chlorodinitrobenzene occurring in dinitromethylaniline obtained by the action of methylamine on chlorodinitrobenzene;

(2) 2,6-dinitromethylaniline which also contaminates technical dinitromethylaniline.

Issoire and Burlet found that 2,6-dinitromethylaniline is nitrated with much greater difficulty than the 2,4-isomer. To obtain tetryl from the 2,6-isomer, nitration should be carried out with nitric acid, s.g. 1.50, i.e. a concentration higher than 95%.

The evolution of heat resulting from the introduction of the nitro group into methylaniline was calculated by Garner and Abernethy [14] as follows. On transition of:

methylaniline to *p*-nitromethylaniline 36.4 kcal/mole,
p-nitromethylaniline to 2,4-dinitromethylaniline 25.2 kcal/mole,
 2,4-dinitromethylaniline to 2,4,6-trinitromethylaniline 11.9 kcal/mole,
 2,4,6-trinitromethylaniline to tetryl 1.0 kcal/mole.

By-products formed during the preparation of tetryl

Apart from tetryl a number of other substances may be found in the products of the reaction. One of them is 2,3,4,6-tetranitrophenylmethylnitramine, *m*-nitrotetryl (VII). This compound was originally reported by Romburgh [15] as accompanying tetryl. Romburgh originally thought that *m*-nitrotoluene is particularly readily formed when tetryl is prepared from methylaniline, due to the fact that the nitro group is directed to the *meta* position by the methylamino group:

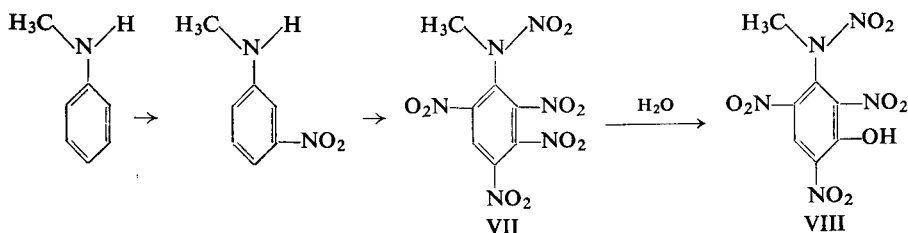

A nitro group at the *meta* position is readily hydrolysed in water to the phenolic group with the formation of the nitro derivative of *N*-methyl-*m*-aminophenol (VIII). Since technical dimethylaniline usually contains a certain amount of methylaniline,

its nitration product always contains a small quantity of the product (VII). This substance may be removed by boiling in water in order to hydrolyse it to the compound (VIII).

Later Romburgh and Schepers [16] explained that the substance (VII) is also formed from dimethylaniline if nitration is carried out in the presence of a large excess of sulphuric acid (20-fold with respect to dimethylaniline). It is evident that the presence of this substance is undesirable owing to the poor stability of the nitro group in the *meta* position and to the formation of metal salts of the substance (VIII) which are sensitive to impact.

According to Desvergnès [17] methylaniline does not form *m*-nitrotetryl when nitrated first with dilute acids and then with more concentrated ones.

Recently, Bogdał and D. Smoleński [18] made an extensive investigation of the conditions of formation of *m*-nitrotetryl. Contrary to the previous work of Romburgh [15] they found that *m*-nitrotetryl was formed in larger quantity when dimethylaniline was nitrated. Methylaniline yielded a smaller amount of *m*-nitrotetryl under identical nitration conditions.

According to these authors the following conditions lead to the formation of *m*-nitrotetryl:

(1) If nitrating mixtures (nitric and sulphuric acids) are used for nitrating dimethyl- and methylaniline dissolved in sulphuric acid, the percentage of *m*-nitrotetryl is higher than when nitrating with nitric acid alone: the figures observed were 39 and 16% respectively.

(2) As the concentration of nitrating mixture falls, the percentage of *m*-nitrotetryl is considerably reduced, e.g. when the water content is 20–25%, the percentage of *m*-nitrotetryl falls to below 1%. This agrees with Desvergnès [17].

(3) A lower temperature of nitration favours the formation of *m*-nitrotetryl, e.g. when dimethylaniline is nitrated at 65 and 0°C the corresponding percentages of *m*-nitrotetryl are 11 and 30%, respectively.

Bogdał and Smoleński [18] also found that the nitration of methylaniline with less concentrated nitration mixtures readily led to formation of oxidation products.

The other substances which are formed apart from tetryl are the benzidine derivatives (IX), (X), and (XI).

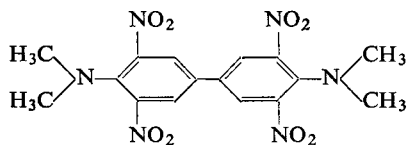

IX, decomposition at 272°C

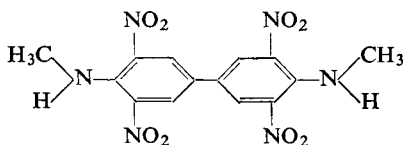

X, decomposition above 200°C

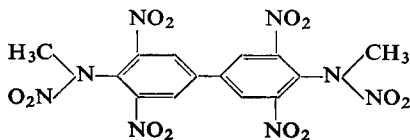

XI, m.p. 222°C (with decomp.)

These substances are insoluble in benzene and hence easily removable from tetryl by crystallization in this solvent. They are fine-crystalline products of a yellowish colour. They increase with the amount of water contained in the nitrating acid. Michler and Pattison [19] proved that N-tetramethylbenzidine is formed by heating dimethylaniline with sulphuric acid.

The same reaction undoubtedly occurs when dimethylaniline is nitrated. Mertens [6] isolated all three substances from the reaction of nitric acid with dimethylaniline and the substances (X) and (XI) by the treatment of methylaniline with nitric acid. Van Romburgh [7, 20] elucidated the structure of these compounds, in particular the position of nitro groups.

The presence of undesirable impurities such as *m*-nitrotetryl and substances which are insoluble in benzene necessitates fairly laborious purification of tetryl. The by-products are formed at the very beginning of the nitration process, before the formation of dinitrodimethylaniline (II). Nitration of highly pure dinitrodimethylaniline yields tetryl containing no such impurities.

GENERAL RULES FOR THE PREPARATION OF TETRYL

In technical operations dimethylaniline is employed as a starting material chiefly because it is obtainable more easily and is much cheaper than methylaniline. Moreover, tetryl prepared from dimethylaniline is purer than that from methylaniline. Hence the preparation of tetryl from dimethylaniline is more economic, in spite of the greater consumption of nitric acid by dimethylaniline which uses up nitric acid to oxidize one of the N-methyl groups. The yield is not higher than 80%, due to the side-reactions.

Since methylamine prepared from methyl alcohol and ammonia has become available commercially, the preparation of tetryl from dinitromethylaniline obtained from chlorodinitrobenzene and methylamine has been widely used.

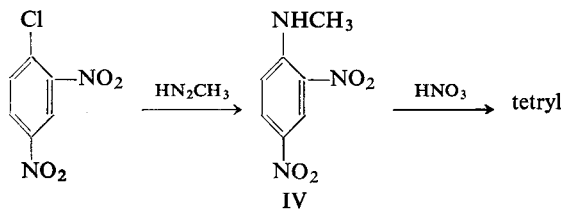

The yield of nitration of dinitromethylaniline amounts to 95%, hence this method is the more economic.

Nitration is usually carried out in such a way that the solution of dimethylaniline in sulphuric acid is introduced into a nitrating mixture rich in nitric acid. The nitration reaction proceeds vigorously, and it is therefore most important to control the reaction temperature. Formerly it was believed that for safety's sake the lowest possible temperature of nitration should be maintained. Later it became clear that at such a temperature nitration is not brought to completion and a large quantity of incompletely nitrated products accumulates, which may lead to an

accident since at a certain moment these products begin to react, emitting a great amount of heat and so creating the possibility that the contents of the nitrator may explode. Thus, too low a temperature of nitration of dimethylaniline is considered to be unsafe.

The nitration of dimethylaniline is now conducted at 68–72°C, with very vigorous stirring. It is usually carried out by pouring gradually a sulphuric acid solution of dimethylaniline sulphate into the nitrating mixture. Due to the high temperature and vigorous stirring the nitration reaction proceeds at once so that there is no danger of the accumulation of under-nitrated products.

Some of the older factory regulations drew attention to the possibility of resinification of the product when a high nitration temperature was used and therefore recommended maintaining a low temperature, i.e. 30–45°C. It was found, however, that resinification of the product can be avoided by very vigorous stirring at high temperatures and by employing a nitrating mixture fairly rich in nitric acid, e.g. 66.5% HNO_3 , 16% H_2SO_4 , 17.5% H_2O .

The nitration method described above is particularly suitable for use in a continuous system.

The purification of tetryl aims at removing by-products such as tetranitro derivative (VII), substances insoluble in benzene and the spent acid occluded by the crystals. The product is washed with cold water and then treated with hot water. This brings about the conversion of compound (VII) to (VIII)—the latter is soluble in hot water. The tetryl is then dissolved in benzene and insoluble constituents removed by filtration. The resulting solution is washed with water until it is completely free from acid. Alternatively, tetryl may be dissolved in acetone, precipitated with water, and finally deacidified.

PHYSICAL PROPERTIES

Tetryl crystallizes in the form of crystals which are colourless immediately after preparation and crystallization but which rapidly turn yellow under the influence of diffused light. The technical product is usually pale yellow.

Chemically pure tetryl melts at 129.45°C although for technical purposes a melting point of 128.8 or 128.5°C is acceptable.

Its crystals belong to the monoclinic system. The product used in industrial practice should be crystalline in form and be easily pourable into a mould for compression. According to Davis [21] a product with mixed, i.e. relatively large and small crystals (Fig. 5), is best suited for this purpose.

Such a product may be prepared by various methods, e.g. by mixing a coarse crystalline substance derived from crystallization in benzene with a fine crystalline one obtained by the precipitation of tetryl with water from an acetone solution. Another method (according to Crater [22]) consists of pouring the benzene solution into water heated to above the boiling point of benzene. Alternatively, crystallization from dichlorethane (according to Rinckenbach and Regad [23]) may produce an acceptable form of tetryl.

The specific gravity of the crystals is 1.73, whereas the product, when fused and poured into a mould, solidifies to a mass with a density of 1.62. Under a pressure of 2000 kg/cm² a density of 1.71 can be attained.

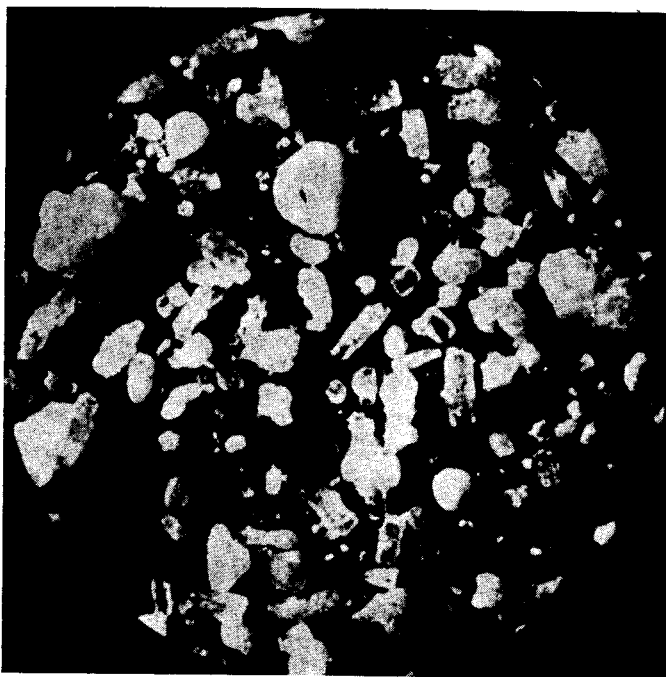

FIG. 5. Tetryl in a free-flowing form, according to Davis [21].

The specific heat of tetryl is as follows (C. A. Taylor and Rinkenbach [24]):

at 0°C	0.213 cal/g°C
at 20°C	0.217 cal/g°C
at 50°C	0.223 cal/g°C
at 80°C	0.228 cal/g°C
at 100°C	0.231 cal/g°C
at 120°C	0.234 cal/g°C

Belayev and Matyushko [25] give 0.225 as the specific heat of tetryl.

Tetryl has a heat of fusion of 20.6 kcal/kg, a heat of combustion of 854.3 kcal/mole, hence the calculated heat of formation ΔH_f is +7.5 kcal/mole (Garner and Abernethy [26]) or +23.7 kcal/mole (Kast [27]).

According to Prentiss [28] the thermal conductivity of tetryl at 25°C is 0.00088. Belayev and Matyushko [25] give 0.00023.

Tetryl is virtually insoluble in water. It dissolves moderately well in concentrated mineral acids, but in spent acid its solubility is barely 0.3%. Conversely, concentrated nitric acid is a good solvent for tetryl. When a solution in concentrated nitric acid is diluted slowly with water, for instance by placing it in a moist atmosphere, gradual precipitation of tetryl occurs. Tetryl dissolves very readily in acetone.

Its solubility in benzene varies [29] depending on whether the substance is heated with benzene to a given temperature (A) or the solution, saturated at a high temperature, is cooled to a given temperature (B). The corresponding values are given in Table 7.

TABLE 8
SOLUBILITY OF TETRYL IN BENZENE

Solubility	Temperature °C				
	15	25	35	45	55
(A) Heating in 100 g of benzene	3.9	5.5	7.4	9.7	13.25
(B) Cooling a saturated solution	10.2	12.2	14.9	18.25	22.5

The big difference between the two states of equilibrium is presumably accounted for by the formation of tetryl solvates with benzene at higher temperatures and their greater solubility in benzene.

The solubility of tetryl in other solvents based on the data of various authors, mainly those of C. A. Taylor and Rinckenbach [24] is tabulated below [21]:

TABLE 9
SOLUBILITY OF TETRYL (g IN 100 g OF SOLVENT)

Temperature °C	Water	Alcohol 95%	Carbon tetrachloride	Chloroform	Dichloroethane	Carbon disulphide	Ether
1	2	3	4	5	6	7	8
0	0.0050	0.320	0.007	0.28	1.5	0.0090	0.188
5	0.0058	0.366	0.011	0.33	—	0.0120	0.273
10	0.0065	0.425	0.015	0.39	—	0.0146	0.330
15	0.0072	0.496	0.020	0.47	—	0.0177	0.377
20	0.0075	0.563	0.025	0.57	3.8	0.0208	0.418
25	0.0080	0.65	0.031	0.68	—	0.0244	0.457
30	0.0085	0.76	0.039	0.79	—	0.0296	0.493
35	0.0094	0.91	0.048	0.97	—	0.0392	—
40	0.0110	1.12	0.058	1.20	7.7	0.0557	—
45	0.0140	1.38	0.073	1.47	—	0.0940	—
50	0.0195	1.72	0.095	1.78	—	—	—
55	0.0270	2.13	0.124	2.23	—	—	—
60	0.0350	2.64	0.154	2.65	18.8	—	—
65	0.0440	3.33	0.193	—	—	—	—
70	0.0535	4.23	0.241	—	—	—	—
75	0.0663	5.33	0.237	—	—	—	—
80	0.0810	—	—	—	—	—	—
85	0.0980	—	—	—	—	—	—
90	0.1220	—	—	—	—	—	—
95	0.1518	—	—	—	—	—	—
100	0.1842	—	—	—	—	—	—

CHEMICAL PROPERTIES

Tetryl is highly resistant to the action of dilute mineral acids. For instance long-continued boiling with dilute sulphuric acid fails to decompose it, whereas in concentrated sulphuric acid the N-nitro group is split off with the formation of trinitromethylaniline (N-methylpicramide) (V) and nitric acid, as shown by Davis and Allen [30] and later confirmed by Lang [12]. This reaction proceeds fairly quickly at elevated temperatures (e.g. 60°C and above) but slowly at room temperature. A solution in sulphuric acid, when brought into contact with mercury, reacts as nitric acid: in the presence of mercury the N-nitro group is reduced to nitric oxide. This enables tetryl to be determined quantitatively in the nitrometer.

When tetryl is boiled with a solution of sodium carbonate or a dilute (e.g. 2%) aqueous solution of potassium or sodium hydroxide, the nitramino group is hydrolysed as follows [3, 6, 31]:

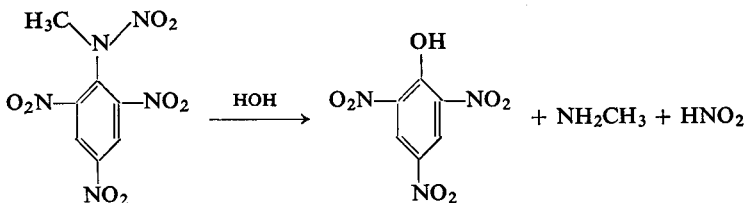

The products obtained are picric acid (in the form of the corresponding picrate), methylamine, and nitrous acid (as nitrite).

On heating with alcoholic ammonia a picramide is formed [3]:

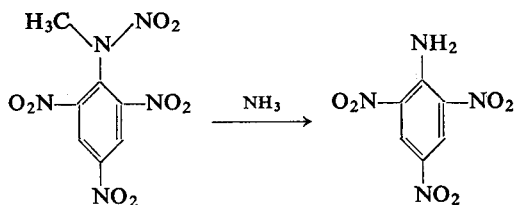

Tetryl combines with aniline in benzene solution even at room temperature to form 2,4,6-trinitrodiphenylamine (XII) and methylnitramine:

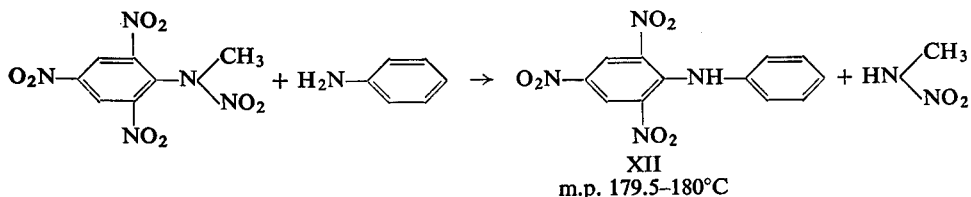

The substance (XII) is precipitated as red crystals, and methylnitramine can be extracted from the solution with water.

The conversion of tetryl into picric acid or methylpicramide (V) may also proceed under milder conditions. Thus Farmer [32] and Desvergnès [33] found that picric

acid can be formed simply by heating tetryl for a prolonged period of time, e.g. at 120°C. According to some authors heating in high-boiling solvents (e.g. in xylene) leads to the conversion of tetryl into N-methylpicramide (V) and picric acid, together with resinous products and unidentified crystalline products.

When heated with phenol, tetryl is converted into trinitrophenylmethylamine (V) (Romburgh [7]; cf. p. 5).

With tin and hydrochloric acid, tetryl is reduced and hydrolysed to form 2,4,6-triaminophenol.

Tetryl combines with an excess of sodium sulphide to form a 13% solution. Even at room temperature the nitro groups are reduced with the formation of a non-explosive substance. This reaction is exploited for the destruction of waste tetryl.

Tetryl is reduced at 80–90°C by the action of a 10% sodium sulphite solution to form a non-explosive product. In a similar manner tetryl reacts with sodium thio-sulphate to yield yellow-coloured, unidentified products.

Yefremov *et al.* [34] studied systems containing tetryl by thermal analysis and found that it forms additive compounds with phenanthrene, fluorene or retene in the mole ratio 1 : 1 which do not melt uniformly. It also forms an additive compound in the same ratio with naphthalene, m.p. 86.8°C.

According to Yefremov and Khaibashev [35], Giua [36], C. A. Taylor and Rinckenbach [37], tetryl and trinitrotoluene form an additive compound in the ratio of one mole of tetryl to two moles of trinitrotoluene which readily dissociates and melts at 61.1°C (Taylor and Rinckenbach report m.p. of the addition compound as 68°C).

Tetryl also forms an ordinary eutectic mixture with 76.5% trinitro-*m*-xylene, m.p. 118.8°C and with 29.5% trinitroanisole, m.p. 22.8°C [35].

At room temperature tetryl appears to be perfectly stable. At 100–120°C the methylnitramino group of tetryl decomposes slightly giving off a certain amount of formaldehyde and nitrogen oxides. On studying the decomposition of tetryl at 120°C under reduced pressure, Farmer [32] found that in 40 hr 1.5–3.0 cm³ of gases are evolved. He also examined its decomposition at lower temperatures and found that the temperature coefficient of decomposition is 1.9 cm³/5°C. By extrapolating the curve in the system: decomposition rate–temperature, Farmer calculated that a decomposition lasting 40 hr at 120°C would take 1700 years at 20°C.

Tests lasting for many years have shown that 20 years of storage, at room temperature involve no discernable changes in tetryl, nor was any distinct decomposition of tetryl observed at 65°C after 12 months; at 75°C after 6 months and at 100°C after 100 hr.

The decomposition rate of tetryl increases sharply (approximately 50-fold) at its melting point. If tetryl contains admixtures which lower its melting point, it begins to decompose at a lower temperature corresponding to the melting point of the mixture. For example, addition of TNT to tetryl markedly increases its rate of decomposition at the melting point of the mixture. This is probably due to the more energy rich and less stable liquid state (see Vol. II, p. 182). When studying

the decomposition kinetics of pure tetryl or of tetryl containing an admixture of picric acid at 140–150°C, Hinshelwood [38] came to the conclusion that the speeding up of the reaction rate results in the formation of picric acid due to the hydrolysis of tetryl at that temperature. The larger the amount of picric acid so formed, the higher is the decomposition rate of the molten tetryl.

Desvergnès [33] found that when tetryl having a m.p. 128.5°C was heated for 24 hr at 100°C its m.p. was lowered by 0.4°C after 600 hr of heating the m.p. had fallen to 71°C.

On heating tetryl at 120°C at reduced pressure (a few mm Hg) the gas evolved in the early stages of the experiment consisted almost entirely of nitrogen and carbon monoxide.

Towards the end of the test appreciable quantities of carbon dioxide were produced. No nitric oxide was detected at any stage of the experiment.

According to van Duin [39] the ignition temperature of tetryl is 196°C; when it is heated from 100°C at the rate of 20°/min, ignition occurs at 187°C.

T. Urbański and Schuck [40] found that tetryl explodes when dropped onto a heated copper surface:

at 236°C after 6.2 sec
 at 260°C after 2.0 sec
 at 280°C after 1.1 sec
 at 302°C after 0.4 sec
 at 310°C instantly

According to Farmer [32] the activation energy of the thermal decomposition of tetryl $E=60.0$ kcal and $\log B=27.5$. Hinshelwood [38] reports similar values. A. J. B. Robertson [41] found, however, that at higher temperatures (211–260°C) $E=38.0$ kcal and $\log B=15.4$. According to Szyk-Lewańska [42] at still higher temperatures (260–300°C) the activation energy is even lower, viz. E =approximately 20.0 kcal (based on the data given above [40]).

Roginskii and Lukin [43] found that tetryl is not liable to explode when heated at 150°C in a sealed ampoule, though at temperatures above 150°C, e.g. between 150 and 170°C, explosion may ensue as result of chain reactions occurring during decomposition on long-continued heating.

EXPLOSIVE PROPERTIES

Lenze [44] was the first to examine the explosive properties of tetryl. It is a more powerful explosive than TNT (its strength, depending on the method of investigation applied, ranges between 110 and 130% of that of TNT). Its sensitiveness to impact and friction, particularly to rifle fire, is higher than that of TNT.

The explosive decomposition of tetryl, like that of other explosives, depends on the method of initiation, density etc. Haid and Schmidt [45] give the following equation for the decomposition of tetryl, at a density of 1.56:

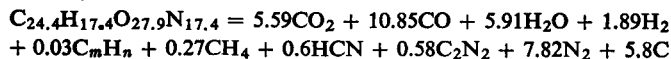

The heat of explosion is 1095 kcal/kg, the volume of gases 750 l./kg, the temperature of explosion 3530°C.

Kast [27] gives similar values: 1090 kcal/kg, 710 l./kg, 3370°C respectively.

According to Carlton Sutton [46], depending on its density tetryl may explode or detonate with widely varying intensity and therefore with different heats of explosion or detonation:

at a density of 0.9 and less with 935 kcal/kg (explosion)
 at a density of 1.1–1.3 with 1070 kcal/kg
 at a density of 1.45–1.71 with 1160 kcal/kg (detonation)

The sensitiveness of tetryl to impact, as reported by several authors, may be expressed as 70–80% of the impact energy necessary to cause the explosion of picric acid.

According to a number of authors, the explosive power of tetryl, determined in the lead block, varies between 340 and 390 cm³, i.e. between 114 and 120% of the value for picric acid.

The rate of detonation of tetryl is reported by various authors as follows:

at a density of 1.0 and 1.53 5450 m/sec and 7215 m/sec
 respectively (J. Marshall [47])
 at a density of 1.0 5600 m/sec (Cook [48])
 at a density of 1.43 6425 m/sec (Selle [49])
 at a density of 1.63–1.65 7200 m/sec (Kast [27])
 at a density of 1.63–1.65 7520 m/sec (R. Robertson [50])
 pressed pellets (no density 7230 m/sec (Koehler [51])
 given)

E. Jones and Mitchell [52] found that under the influence of a standard No. 6 detonator, a charge of tetryl at a loading density of 0.94 and 25 mm dia. initially detonates at a low rate which increases after a certain distance (the authors give no figures).

The explosive power of tetryl at a loading density of 0.3, was compared with that of other explosives in a manometric bomb by Koehler [51] who determined the following pressure values from which the temperatures of explosion have been computed:

TABLE 10

Explosive	Pressure kg/cm ²	Temperature of explosion °C
Tetryl	4684	2911
Picric acid	3638	2419
Trinitrotoluene	3749	2060
Trinitrobenzene	3925	2356

When confined in a 24 mm diameter tube, tetryl is capable of burning. According to Andreyev [53], at a density of 0.9, the rate of burning of tetryl can be expressed as a function of temperature by the equation:

$$\frac{1}{u_m} = 31.50 - 0.055 T_0$$

The diagram (Fig. 6) shows the dependence of u_m and $\frac{1}{u_m}$ on temperature.

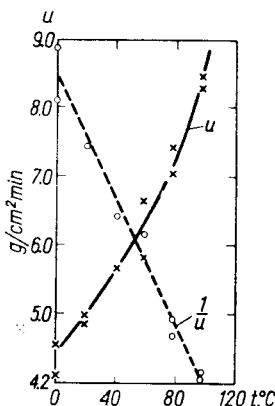

FIG. 6. Rate of burning of tetryl against initial temperature, according to Andreyev [53].

A very important property of tetryl is its sensitiveness to initiation by a primer—hence its rapid rise in importance as an explosive for use in detonating caps, gains (boosters) etc. Martin [54] gives the following figures comparing the sensitiveness to initiation of tetryl and trinitrotoluene, under the influence of various primary explosives (Table 11).

TABLE 11

Primary explosive	Minimum charge (grammes) for detonation of	
	Trinitrotoluene	Tetryl
Mercury fulminate	0.36	0.29
Silver fulminate	0.095	0.02
Lead azide	0.09	0.025
Silver azide	0.07	0.02

W. Taylor and Cope [55] determined the minimum charge of a mixture of mercury fulminate (90%) and potassium chlorate (10%) necessary to detonate mixtures of trinitrotoluene and tetryl (Table 12).

TABLE 12

Composition of mixture per cent		Weight of initiator g
Trinitrotoluene	Tetryl	
100	0	0.25
90	10	0.22
80	20	0.21
50	50	0.20
0	100	0.19

TOXICITY

Tetryl is a toxic substance. Breathing its dust induces symptoms of poisoning. A concentration of 1.5 mg/m³ of tetryl dust in the air is reported noxious (Troup [56]) but a lower concentration may be toxic. Tetryl has a particularly potent effect on the skin, producing symptoms of an allergic character: the skin turns yellow and dermatitis develops. Thus workers employed in production, especially those engaged in handling tetryl, should be provided with protective clothing. Parts of the body exposed to tetryl dust should be protected by barrier cream containing 10% of sodium perborate. Daily baths are essential. The presence of tetryl dust in the air often causes irritation of the upper respiratory tract. Tetryl poisoning is also accompanied by general symptoms such as lack of appetite, insomnia, giddiness etc.

The symptoms usually occur 2–3 weeks after beginning work with tetryl. In many cases (60–68%) some adaptation occurs and the effects of the poison appear less pronounced.

Witkowski *et al.* [57] report that in one factory in the U.S.A. during World War II out of 1258 workers engaged in handling tetryl 944 fell ill, while in another, 404 out of 800–900 were affected.

TETRYL MANUFACTURE

Nitration of dimethylaniline

According to Sokolov [58] dimethylaniline used for the manufacture of tetryl should be a pale-yellow liquid, s.g. 0.955–0.960 at 15°C, b.p. 192–194°C, not less than 95% of the substance distilling between 192.7 and 193.7°C. It must not contain water or aniline. Only traces of methylaniline are permissible.

The nitric and sulphuric acids should be purified to the extent usually required for nitrating acids. Nitric acid of 92–98% concentration, containing not more than 3% of nitric oxides is commonly utilized. The concentration of sulphuric acid may vary between 96 and 99%. The nitrating mixture should be rich in nitric acid, i.e. **containing not less than 65% of HNO₃.**

The production of dimethylaniline sulphate

In the manufacture of tetryl, it is usual not to nitrate dimethylaniline directly, but to dissolve it first in concentrated sulphuric acid and then to nitrate the dimethylaniline sulphate so obtained. Straightforward nitration of dimethylaniline proceeds so violently, that it can be carried out only under the special conditions described on pp. 42–43. Many years' experience of tetryl manufacture has shown that the ratio of sulphuric acid to dimethylaniline should not be lower than 3 : 1, a smaller amount of sulphuric acid may be detrimental to the nitration process. (Nitration by a periodic (discontinuous) method may cause ignition in the nitrator due to the fact that

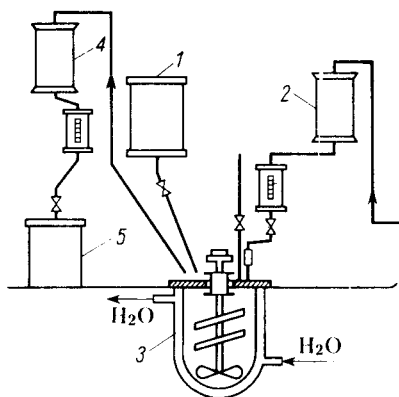

FIG. 7. Flow diagram of plant for dissolving dimethylaniline in sulphuric acid, according to Sokolov [58].

a portion of dimethylaniline was not previously converted into sulphate.) The proportion of sulphuric acid to dimethylaniline should not however be too high, e.g. a ratio of 100 : 1 has a detrimental effect on the yield of tetryl. While the dimethylaniline is dissolving the temperature should be maintained between 20 and 45°C, but not higher, to avoid sulphonation of the benzene ring.

The lay-out of a plant for dissolving dimethylaniline in sulphuric acid (according to Sokolov [58]) is shown, with some modifications, in Fig. 7. It comprises a dosing tank (1) for sulphuric acid and dosing tank (2) for dimethylaniline. First, 14,400 kg of 96% sulphuric acid are poured into reactor (3) followed by 1000 kg of dimethylaniline maintaining the temperature between 25 and 30°C. The dimethylaniline is poured in over a period of about 3 hr, and the contents of the reactor are then maintained for 30 min at 40°C and finally cooled to 20°C. The solution of dimethylaniline sulphate so obtained is pumped over to container (4), whence it flows down to nitrator (5).

Before nitration the solution of dimethylaniline sulphate is tested for the presence of free dimethylaniline by treating a test sample with a large amount of water. If free dimethylaniline is present the solution is cloudy. This test is of great importance (see above).

Nitration (see Bain [59] and Rinckenbach [29]). A continuous method of nitration at 70°C is the safest and most advantageous. The lay-out shown diagrammatically in Fig. 8 is typical.

The nitrating acid is metered in the dosing tank (1) and the dimethylaniline solution in the dosing tank (2). Both liquids are introduced into the nitrator I, their

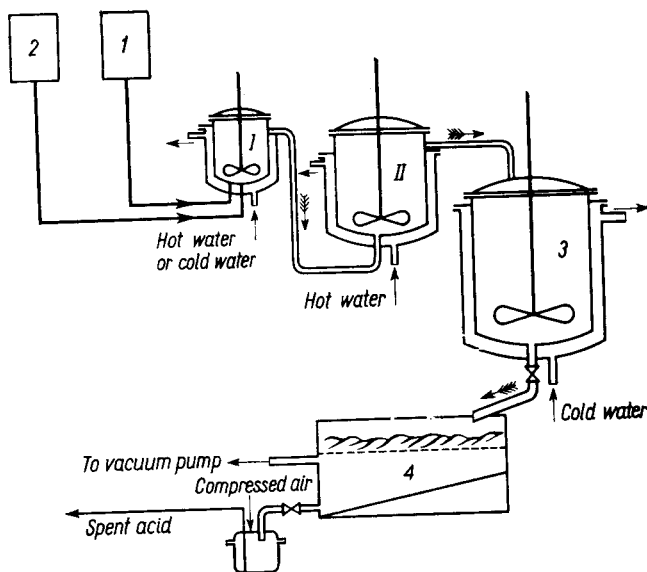

FIG. 8. Flow diagram of plant for continuous nitration of dimethylaniline.

rate of inflow being so regulated that 15.4 parts of the dimethylaniline solution in sulphuric acid mix with 9.2 parts of nitrating mixture composed of:

HNO ₃	67%
H ₂ SO ₄	16%
H ₂ O	17%

The contents of the nitrator are heated to a temperature of 68°C and heating is then discontinued and the temperature in the nitrator maintained at 60 to 72°C. The nitrator is cooled externally, if necessary. For safe and efficient nitration very vigorous stirring is essential to ensure that the reacting liquids are mixed almost instantaneously. Since the mixture is kept in nitrator I for a very short period, reaction may be incomplete. Its contents are discharged via an overflow to a larger reactor II, also provided with a stirrer. In reactor II the same temperature (70°C) is maintained by heating. Here the reaction is completed and the liquid, together with the partly crystallized product, is allowed to run into crystallizer (3) in which the whole is cooled to 20°C and afterwards discharged to the vacuum filter (4). Tetryl is collected on the filter and the spent acid is passed on to be denitrated.

Here, as in other continuous processes involving rather risky exothermic reactions, the following precautions for ensuring the safety of personnel are of utmost importance:

(1) A stainless steel cooling coil should be fitted inside the nitrator to make possible a rapid heat removal to enable the contents to be cooled very rapidly (the coil is not shown in Fig. 8).

(2) Vigorous and reliable stirring is essential. The stirrer should be provided with a spare d.c. motor driven by a battery, to replace the main motor in case of damage. A compressed air pipe should also be fitted to supply air to the nitrator as a last resort.

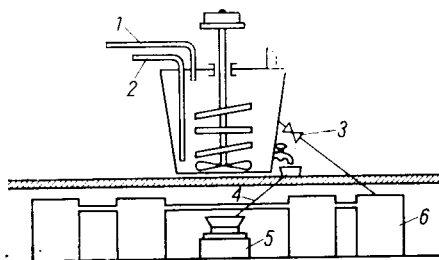

FIG. 9. Flow diagram of plant for washing tetryl, according to Sokolov [58].

On nitration, carbon dioxide and nitrogen dioxide are evolved. These gases are passed to water absorption towers where considerable amounts of nitric acid are recovered.

Washing the tetryl. The filtered product is despatched in aluminium barrels from the nitration department to a special room where it is poured into a washing tank (Fig. 9). The tank of 1350 l. capacity, fitted with a stirrer, may be of wood lined with stainless steel. It is fed with water through pipe (1), and is heated by direct steam injection through pipe (2).

The contents of the tank are stirred with water for 30 min and allowed to stand for 30–40 min. The aqueous layer is decanted through the top valve (3) into a number of settling tanks (6). The tetryl is washed first with cold water, and then by a succession of washings at increasing temperatures: 40, 60, 80, and 90 or 100°C.

After washing the product is discharged through a wide valve and channel (4) to a vacuum filter (5). After filtration and the removal of water, wet tetryl containing 16–18% of water is passed on for crystallization. Tetryl is also collected from the settling tanks every 10 days. This tetryl may contain sand and other mechanical impurities, and must therefore be crystallized.

Washed tetryl should not contain more than 0.015% of acid (calculated as H_2SO_4). If the acidity is higher, the product is given an additional wash. Washed tetryl crystallizes into yellow or reddish-yellow crystals.

Crystallization from benzene. For crystallization wet, freshly washed, deacidified tetryl is used. It is introduced into container (1) (Fig. 10) equipped with a mixer, a heating jacket and a reflux condenser (2). Container (1) is filled with benzene. The whole is heated, while stirring, until the tetryl is dissolved. The solution is then passed through the warmed filter (3). The products insoluble in benzene are retained

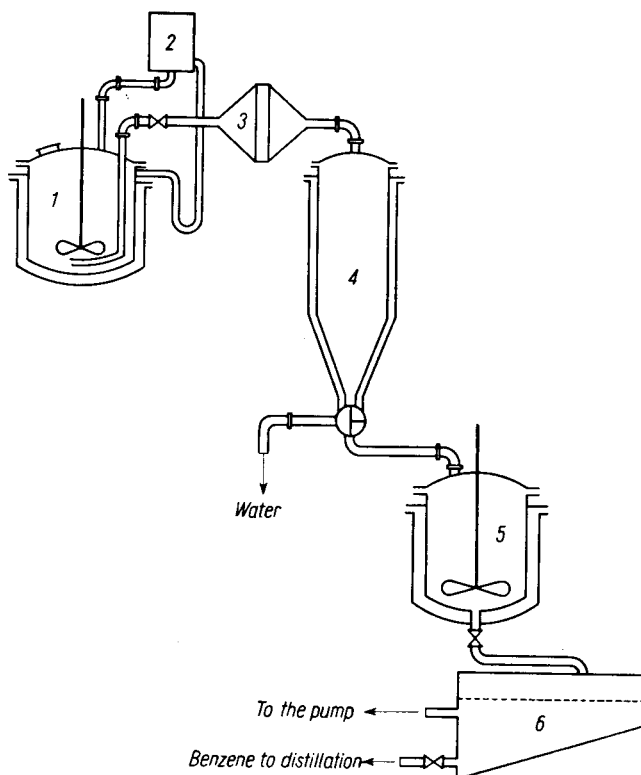

FIG. 10. Flow diagram of plant for the crystallization of tetryl.

on the filter. The clarified benzene solution, with an aqueous layer, is conveyed to the warmed separator (4) in which the lower aqueous layer is separated. The aqueous layer contains the residual acid washed out of the benzene solution of tetryl. The benzene solution is transferred to the crystallizer (5) in which the crystallization of tetryl takes place on cooling. The crystals of tetryl are then separated from the mother liquor on the vacuum filter (6). Tetryl should not be separated in centrifuge, as this is considered too dangerous.

The tetryl is then dried for 24 hr in a shelf drier at 55–60°C. This period, however, may be reduced to 12 hr if a vacuum drier is employed.

All possible safety measures usually employed with sensitive and dangerous explosives must be taken in the drier, e.g. the frequent dusting of heaters, sweeping of floors etc.

The dried, crystalline tetryl is sifted on vibrating, well-earthened copper screens.

Crystallization from acetone. Tetryl may be crystallized from acetone by cooling, but crystallization by precipitation with water is preferable, as this permits removal of traces of acid and gives a very fine crystalline product which, when mixed with the product prepared by crystallization from benzene, forms a free-flowing mixture. The plant is, in principle, similar to that represented in Fig. 10, except that separation is unnecessary and a much larger crystallization vessel is needed to hold both the solution and the added water.

According to the Soviet standard specification WST 5, top-grade tetryl should meet the following requirements:

Freezing point, min.	127.7°C
Moisture and volatile matter, max.	0.02%
Substances insoluble in acetone, max.	1 %
Acidity (calculated as H ₂ SO ₄), max.	0.01%

According to U.S. requirements [59], high grade tetryl should possess the following characteristics:

M.p.	128.5–129.1°C
Acidity	not more than 0.08% (H ₂ SO ₄)
120°C vacuum test not more than 4.0 cm ³ of gas evolved in 40 hr.	

Nitration of dinitromethylaniline

According to the German (Griesheim) method [60] tetryl is manufactured in two stages: first dinitromethylaniline is prepared and this is then nitrated.

Dinitromethylaniline is produced by the reaction of chlorodinitrobenzene with methylamine in the presence of sodium hydroxide. A solution is prepared consisting of 300 l. of water, 1140 l. of 35% aqueous sodium hydroxide solution and 1225 kg of 25% aqueous methylamine solution. This solution is added over a period of 12 hr to a vigorously stirred suspension of 2000 kg of chlorodinitrobenzene in 1350 l. of water heated to 95–100°C.

All is stirred for one hour longer and then the product is cooled (still stirring). After being allowed to crystallize, it is centrifuged. The dinitromethylaniline so obtained is nitrated in a similar manner to dimethylaniline. Nitration proceeds without such an abundant evolution of gaseous products, it is less violent and may be conducted at a lower temperature.

According to Desseigne [61] the reaction is carried out with a 20% excess of HNO₃. The concentration of sulphuric acid employed for dissolving the dinitromethylaniline and in the nitrating mixture is so matched that the nitrating mixture always contains 16% of water as the sulphuric solution of dinitromethylaniline is poured into the nitrator during nitration. The composition of the nitrating mixture is:

HNO ₃	78%
H ₂ SO ₄	6%
H ₂ O	16%

To dissolve dinitromethylaniline in sulphuric acid a mixture of 860 parts of spent acid from a previous nitration is used, together with 168.5 parts of 95% sulphuric acid and 117.5 parts of 20% oleum. The spent acid contains:

HNO ₃	1.0%
NO ₂	0.5%
H ₂ SO ₄	82.5%
H ₂ O	16.0%

The dinitromethylaniline solution in sulphuric acid is introduced slowly into the nitrator containing the nitrating mixture. The addition takes about 1 hr and the temperature of the mixture is maintained at 30°C.

The precipitation of tetryl begins about 10 min after the reaction has started.

After mixing the two solutions, the temperature is raised to 50–55°C and maintained thus for 40 min. The presence of crystals in the semi-liquid mixture results in a violet colour which gradually changes to grey and then to yellow. Nitration is judged to be complete when the colour turns pale-yellow. The contents of the nitrator are then cooled to 20°C and the product is filtered off on a vacuum filter. Spent acid (1290 parts) is drawn off, $\frac{2}{3}$ of it returning to nitration and $\frac{1}{3}$ going to denitration.

The filtered tetryl is added to water (500 parts) so heated that on the addition of tetryl its temperature is 50°C. The mixture is then stirred for 10–15 min, and the tetryl filtered and washed with cold water until free of acid (helianthine test). After washing, the tetryl is dried at 70°C.

From 100 parts of dinitromethylaniline 138.6 parts of tetryl can be obtained, i.e. 95.3% of the theoretical yield. The m.p. of the tetryl so produced is 128.4°C. If necessary, it can be re-crystallized.

The raw material consumption per 1000 kg of tetryl produced is:

720 kg of dinitromethylaniline
617 kg of 95% sulphuric acid
642 kg of 20% oleum
507 kg of nitrating mixture containing 87% of HNO ₃ and 5% of H ₂ O
165 kg of 50% nitric acid.

HOMOLOGUES AND ANALOGUES OF TETRYL

2,4,6-Trinitro-3-methylphenylmethylnitramine (methyltetryl, tolyltetryl)

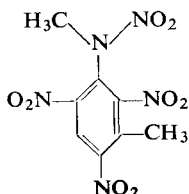

m.p. 101–101.5°C

Romburgh [62] prepared this product by the nitration of *N*-dimethyl-*m*-toluidine, British authors [63] obtained it in the following manner during World War I using the product of sulphitation of γ -trinitrofluene, the main isomer of α -trinitrotoluene (Vol. I):

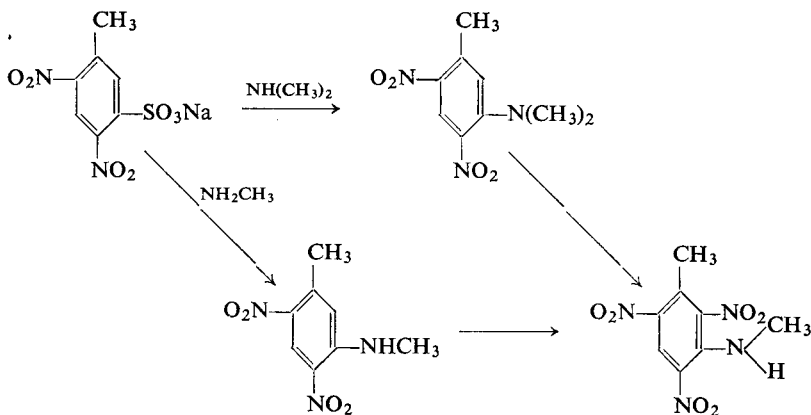

This course of reaction was confirmed by T. Urbański and Schuck [40] who also found that the final product is somewhat more stable to heat than tetryl. Instantaneous explosion, for example, occurred on contact with a metal surface heated to 320°C (tetryl explodes at 310°C).

It is an explosive of approximately the same power as picric acid.

2,3,4,6-Tetranitrophenylmethylnitramine and its derivatives

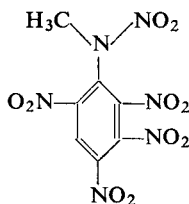

m.p. $146\text{--}147^\circ\text{C}$

VII

According to Romburgh [64, 16] this substance is thought to be an impurity of tetryl arising during the nitration of dimethylaniline and, with peculiar ease, when methylaniline is nitrated. This is due to the fact that from the beginning of nitration the nitro group may take the *meta*-position with respect to the methylamine group.

The formation of this substance by the nitration of *m*-nitromethylaniline was examined by Blanksma [65] and the conditions of its conversion into a number of other substances by the substitution of the nitro group at the *meta*-position with

the OH, OCH₃, NH₂, NHCH₃ groups were elucidated by van Duin and van Lennep [66]:

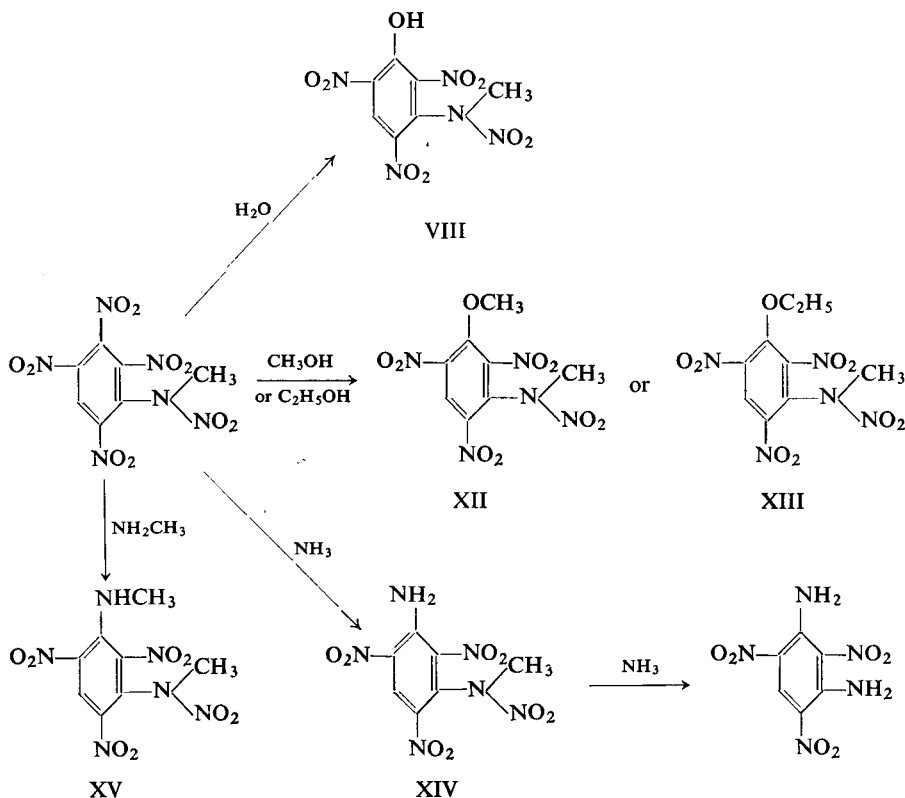

These are the following compounds:

- (VIII) 2,4,6-trinitro-3-methylnitraminophenol (m.p. 183°C)
- (XII) 2,4,6-trinitro-3-methylnitraminoanisole (m.p. 96–97°C)
- (XIII) 2,4,6-trinitro-3-methylnitraminophenetole (m.p. 98–99°C)
- (XIV) 2,4,6-trinitro-3-methylnitraminoaniline (m.p. 188°C; under the prolonged influence of more concentrated ammonia 2,4,6-trinitro-*m*-phenylenediamine is formed; Vol. I)
- (XV) 2,4,6-trinitro-3-methylnitramino-*N*-methylaniline (m.p. 190–192°C).

All these substances have been examined [66] with reference to their sensitiveness and stability (Table 13).

Owing to the presence of the phenolic group, the substance (VIII) forms explosive salts. Its lead salt, however, is of no practical value owing to its hygroscopicity.

The substance (XV) is susceptible to further nitration resulting in the formation of a dinitramine described below (so-called ditetryl).

TABLE 13

Substance	Sensitiveness to impact Maximum height of drop (cm) not causing explosion		Ignition temperature °C	Stability
	2 kg	10 kg		
VIII	30-33	—	197	Stable at 95°C for 3 days
XII	—	15-16	198	Decomposition at 90°C after 2 hr
XIII	—	16-19	202	Decomposition at 90°C after 2 hr
XIV	43-45	—	201	Stable at 95°C for 30 days
Tetryl (standard)	50-51	14	196	Stable at 95°C for 185 days

2,3,4,5,6-Pentanitrophenyl-N-methylnitramine (N-2,3,4,5,6-hexanitro-N-methylaniline)

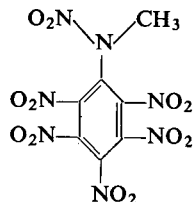

m.p. 132°C (decomp.)

This substance was obtained by Blanksma [67] by the nitration of a mixture of 3,5-dinitro-N-methylaniline and 3,5-dinitro-N,N-dimethylaniline.

It is unstable and decomposes readily above its m.p. or when boiled in water.

2,4,6-Trinitro-1,3-di(methylnitramino)-benzene (ditetryl)

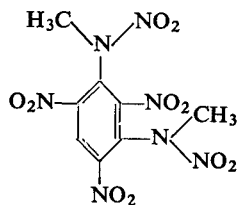

m.p. 206°C

Romburgh [68] was the first to prepare this explosive compound by the nitration of N,N'-dimethyl- or N,N'-tetramethyl-*m*-phenylenediamine. A more practical method was developed by van Duin and van Lennep [66] who started from tetranitrophenyl-methylnitramine (VII) (p. 63):

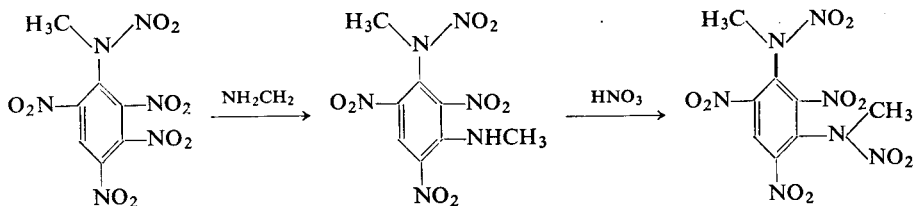

Its chemical properties are very similar to those of tetryl.

Ditetryl is more sensitive to impact than tetryl (it is exploded by a 2 kg weight falling 21–26 cm as compared with 49–51 cm for tetryl). Its ignition temperature is 214°C (that of tetryl is 196°C). It is much less stable than tetryl: decomposition occurred on heating at 95°C for 4 days (tetryl withstands 185 days heating [66]).

2,4,6-Trinitro-1,3,5-tri(methylnitramino)-benzene (tritetryl)

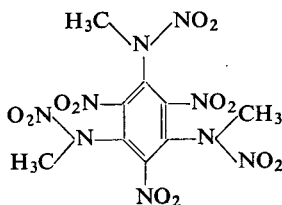

m.p. 280°C (decomp.)

This product was prepared by Blanksma [69] by the nitration of 2,4,6-trinitro-1,3,5-trimethylaminobenzene. The latter was obtained from 3,5-dichloro-(or di-bromo)-2,4,6-trinitroanisole by the action of an alcoholic solution of methylamine.

T. Urbański [70] reported a more convenient method of tritetryl preparation, starting from symmetrical trichlorotrinitrobenzene:

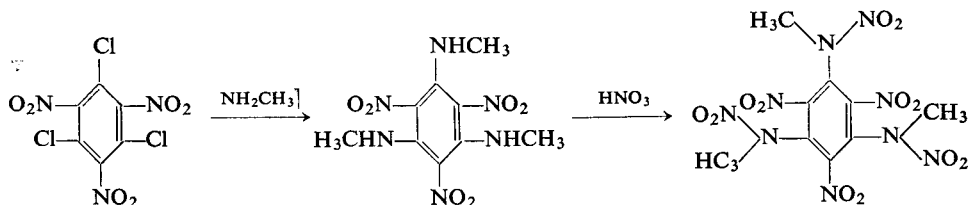

m.p. 268–270°C

T. Urbański investigated its explosive power in a manometric bomb at a density of 0.05 and found it to be more powerful than trinitrotoluene (by about 46%):

Trinitrotoluene	– pressure 420 kg/cm ²
Tetryl	– pressure 580 kg/cm ²
Tritetryl	– pressure 613 kg/cm ²

According to Médard [71] tritetryl gave a lead block expansion of 130 (taking the value for picric acid as 100). Under a pressure of 1500 kg/cm², a density of 1.43 was obtained.

2,4,6-Trinitrophenylethylnitramine (ethyltetryl)

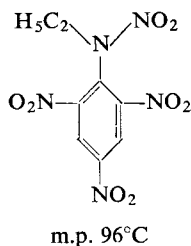

Romburgh [3] was the first to prepare this substance both by nitrating ethylaniline and by nitrating diethylaniline. It is comparable to tetryl in its physical and chemical properties. As an explosive it is weaker than tetryl. Its sensitiveness to impact and its explosive power, measured in the lead block, are somewhat greater than those of picric acid.

According to Médard [71] ethyltetryl gave a lead block expansion of 104 (taking the value for picric acid as 100). Under a pressure of 1500 kg/cm³, a density of 1.63 was obtained.

2,4,6-Trinitrophenyl-n-butyl nitramine (butyltetryl)

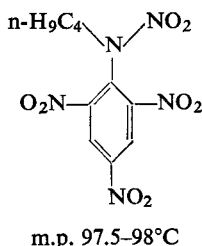

This product has been prepared both by the nitration of N-n-butylaniline and by the action of n-butylamine on chlorodinitrobenzene followed by nitration of dinitro-N-n-butylaniline.

Tetryl and butyltetryl are alike in their physical and chemical properties. The latter is notable for its low sensitiveness to impact, very similar to that of trinitrotoluene. Since it is slightly more powerful than trinitrotoluene and at the same time highly sensitive to detonation by mercury fulminate, it was suggested (Davis [72]) for use in detonators, gains (boosters) and other initiating or priming charges.

THE POLYCYCLIC ANALOGUES OF TETRYL

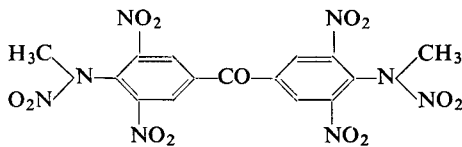
3,5,3',5'-Tetranitro-4,4'-di(methylnitramino)-benzophenone

m.p. 200°C

Romburgh [73] prepared this substance by nitrating Michler's ketone. Galinowski and T. Urbański [74] obtained the same substance by nitrating auramine with a mixture of nitric and sulphuric acids. On heating with 2% KOH the substance was converted into the corresponding nitrophenol.

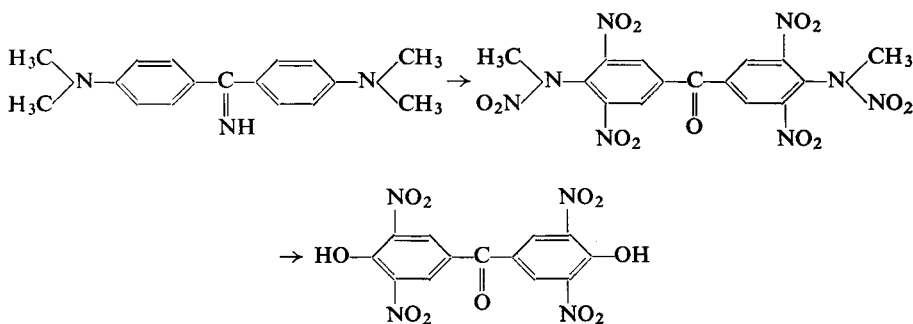
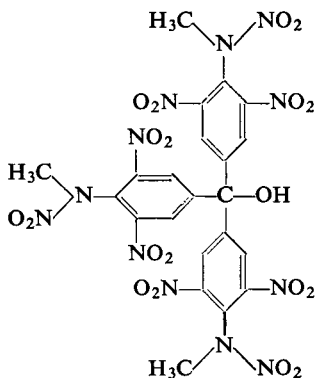
**3,5,3',5',3'',5''-Hexanitro-4,4',4''-tri(methylnitramino)-triphenylcarbinol**

I, decomposition 228°C

Galinoski and T. Urbański [74] prepared this substance by nitration of crystal violet with a mixture of nitric and sulphuric acids. On heating with 2% KOH two products were formed: a semi-quinone (II) and a phenol (III).

Compound (II), on treatment with concentrated nitric acid, adds a molecule of nitric acid and reverts to compound (I):

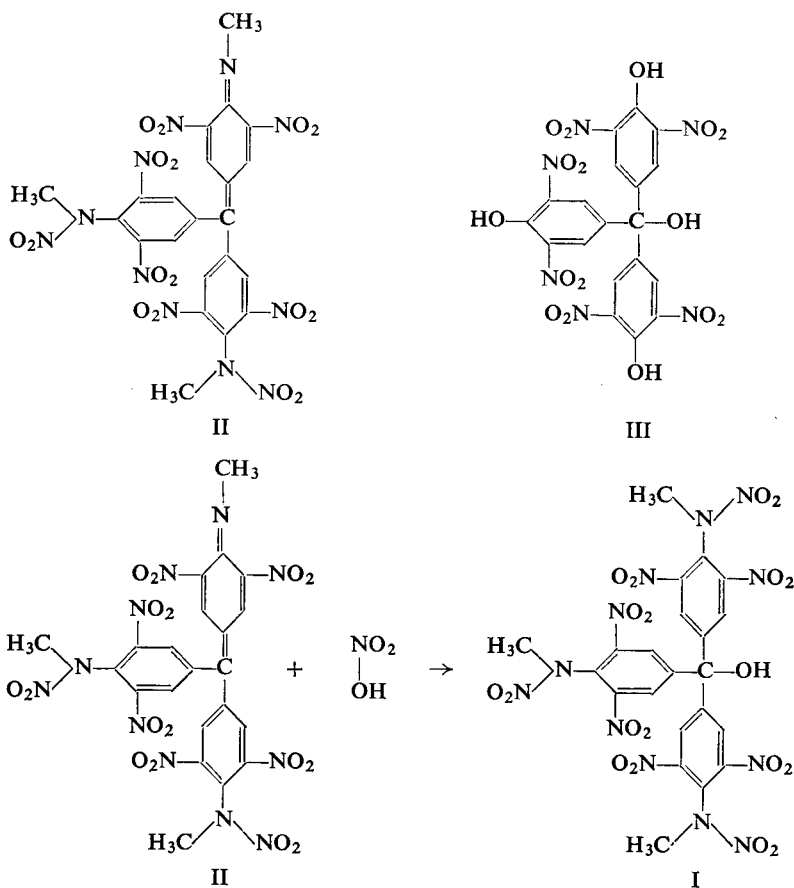

Hexanitrodiphenylethylenedinitramine (also called *diteteryl**, *biteteryl*, or *octyl*)

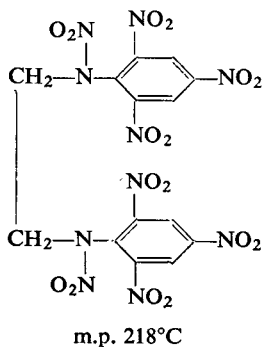

* The same name is applied to the compound described on p. 65.

It seems probable that this compound may find a practical application. It was first prepared by Bennett [75] by the nitration of diphenylethylenediamine with a mixture of concentrated sulphuric acid and anhydrous nitric acid at 30–35°C. Later Cox [76] worked out a practical method for its use in detonators.

It is most conveniently prepared by the interaction of ethylenediamine and chlorodinitrobenzene, followed by the nitration of the amine so obtained:

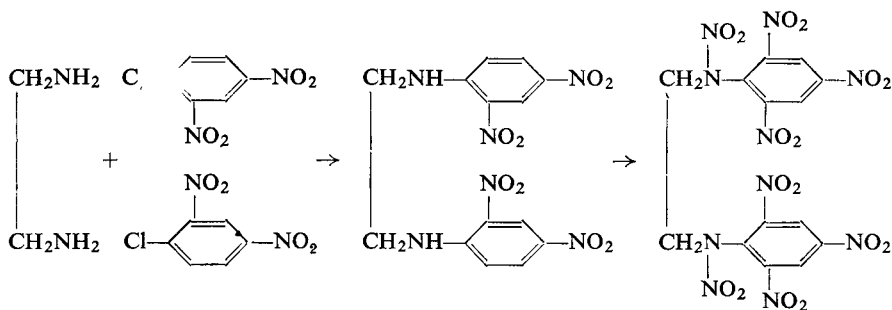

The substance is fairly stable. It resembles tetryl in its explosive power, but is more like penthrite in its sensitiveness to impact.

According to Médard [71] compression under 1500 kg/cm² gives a density of 1.50. Its rate of detonation at a density of 1.60 is 7.350 m/sec and its lead block expansion is 115 (taking the value for picric acid as 100).

NITRAMINO-ESTERS OF NITRIC ACID

Trinitrophenyl-β-hydroxynitraminoethyl nitrate (pentryl, pentyl)

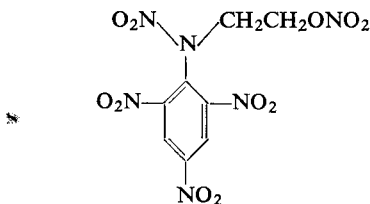

m.p. 126°C

This is a crystalline product readily soluble in most organic solvents, including nitroglycerine. It was prepared and recommended as an explosive by Moran [77], and later examined in detail by Clark [78] and Romburgh [79].

Pentryl has been prepared by two methods: (a) from aniline and ethylene oxide (according to Herz [80]) and (b) from chlorodinitrobenzene and ethanolamine (according to Moran) with the subsequent nitration of N-hydroxyethylaniline or its dinitro derivative:

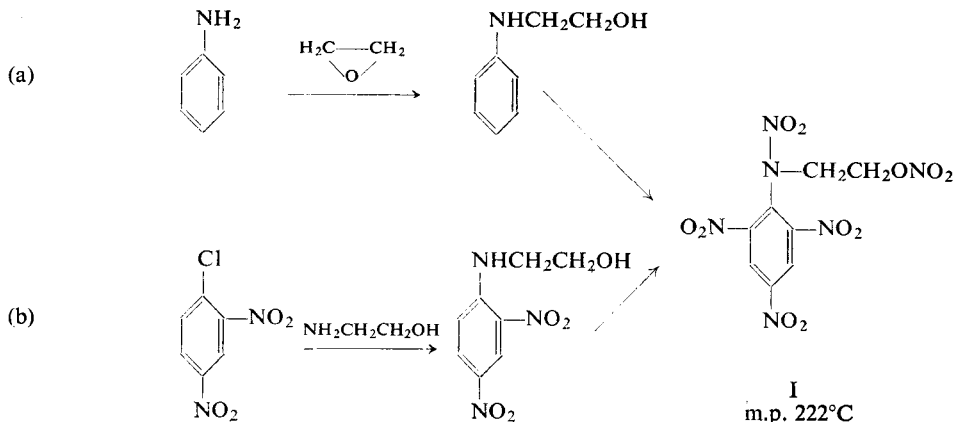

When using method (b) a certain amount of the diphenylamine derivative (II) is also formed as a by-product:

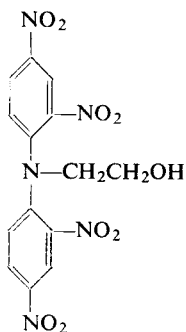

II

The specific gravity of pentryl is 1.82, and its apparent density 0.45. Under a pressure of about 230 kg/cm² a density of 0.74 may be obtained.

In contact with a metal surface heated to 235°C, pentryl explodes in 3 sec. The chemical stability of pentryl is considered satisfactory.

Pentryl is remarkable for its high explosive power which, according to various authors, is equal to or slightly higher than that of tetryl. For instance it gives a lead block expansion 20% larger than that of tetryl. At a density of 0.80 its rate of detonation is 5400 m/sec, that of trinitrotoluene being 4450 m/sec (for an equal sized charge).

Pentryl is less sensitive to impact than tetryl (according to Clark, the maximum height causing no explosion in the drop test is 50 cm for pentryl, whereas for tetryl it is 27.5 cm and for picric acid 42.5 cm).

Médard [71] reports that pentryl, at a density of 1.56, detonates at the rate of 7180 m/sec and its lead block expansion is 114 (taking the value for picric acid as 100). Under a pressure of 1500 kg/cm², a density of 1.68 is obtained.

The minimum initiating charges for pentryl as compared with other explosives (according to Clark [78]) are listed in Table 14.

TABLE 14

Substance	Mercury fulminate g	Lead azide g
Pentryl	0.150	0.025
Tetryl	0.165	0.03
Picric acid	0.025	0.12
Trinitrotoluene	0.240	0.16

Hexanitrodiphenyl- β -hydroxynitraminoethyl nitrate

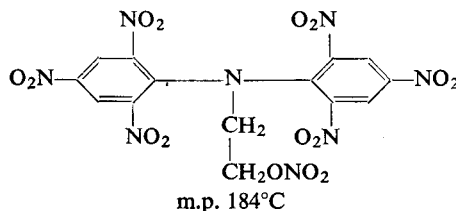

According to Clark [81] this compound is obtained by the nitration of tetra-nitrodiphenyl- β -hydroxyaminoethane (II) which is formed as a by-product when preparing dinitrotriphenyl- β -hydroxyaminoethane from chlorodinitrobenzene and ethanolamine (see above, p. 71).

The explosive properties of hexanitrodiphenyl- β -hydroxynitraminoethyl nitrate are similar to those of pentryl. It is slightly more stable on heating; its ignition temperature lies between 390 and 400°C. It is somewhat less sensitive to impact than pentryl and rather more powerful (by 3%) in the lead block test. It requires a stronger initiator than pentryl, tetryl or picric acid, but a weaker one than trinitrotoluene.

NITRAMINONITROPHENOLS

The only compound of this type described in the literature is 2,6-di-(methylnitraminomethyl)-4-nitrophenol (I). The location of the C-nitro group has not been determined so that a formula with NO₂ at the *ortho* position with respect to the phenol group is also possible.

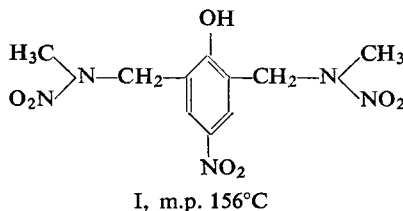

This compound has been described by Semeńczuk [82]. It was prepared by the nitration of 2,4,6-tri-(dimethylaminomethyl)-phenol (II) with nitric acid, s.g. 1.40,

at 40°C. The starting substance was obtained by the condensation of phenol with formaldehyde and dimethylamine, according to Bruson and MacMullen [83].

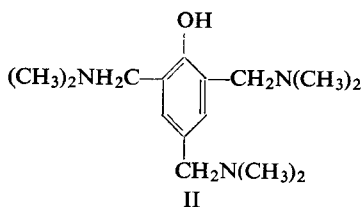

Vigorous reaction with nitric acid, s.g. 1.40, e.g. at 80°C, for 2 hr, causes the substance (I) to undergo nitrolysis and nitration to form picric acid.

The substance (I) is a moderately powerful explosive: it gives an expansion of 250 cm³ in the lead block. It is less sensitive to impact than trinitrotoluene. Its ignition temperature (195–200°C) is about the same as that of tetryl. It forms inflammable salts. The lead, thallose and potassium salts burn violently with a sharp report.

NITRAMINO-AZOXY COMPOUNDS

By the nitration of bis(4,4'-dimethylamino)-azoxybenzene T. Urbański and J. Urbański [84] obtained a hexanitroazoxy derivative (azoxytetryl) of the structure (I) i.e. 3,3',5,5'-tetranitro-bis(4,4'-nitromethylamino)-azoxybenzene

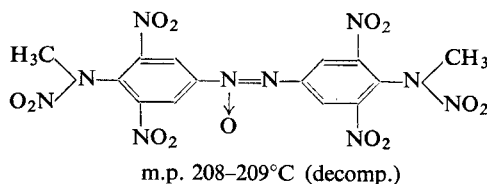

NITRO METHYLENE BLUE

A few nitro derivatives of methylene blue have been described. By introducing one nitro group under mild conditions (nitric acid of *ca.* 20% and sodium nitrite) methylene green was obtained [85].

According to Gnehm [86] methylene blue, when subjected to the action of nitric acid (density 1.33, i.e. 52%) in presence of acetic acid diluted to 50%, yields "dinitrodimethylthionine" nitrate of suggested structure (I).

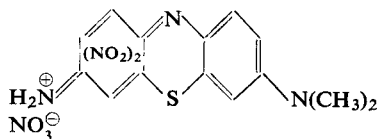

The position of two nitro groups was unknown.

According to the author mentioned, one of the two dimethylamino groups was fully demethylated.

Experiments carried out by T. Urbański, Szyć-Lewańska and Kalinowski [87] suggest the structure of 2,4-dinitro-3-(methyl)nitramino-7-(dimethyl)amino-5,5-dioxyphenothiazine (II) for the Gnehm product. The phenol produced by alkaline hydrolysis has the structure of 2,4-dinitro-3-hydroxy-7-(dimethyl)amino-5,5-dioxyphenothiazine (III)

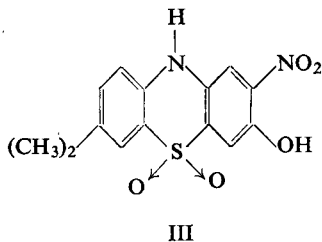
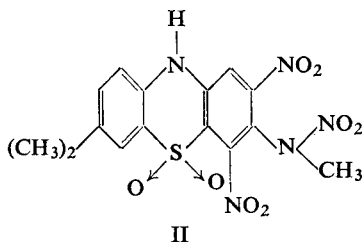

According to the same authors [87] energetic nitration of methylene blue may yield 2,4,6,8-tetranitro-3,7-di(methylnitramino)-5,5-dioxyphenothiazine (IV). This substance, when warmed with a 2% solution of NaOH, underwent the usual hydrolysis of the nitroamino group, placed in *ortho* position, to two nitro groups and yielded phenol (V).

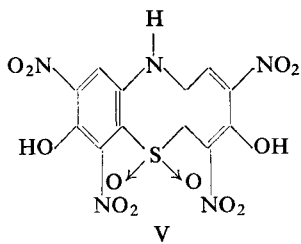
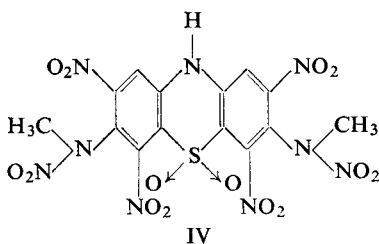

The product of Gnehm forms an intermediate stage between methylene blue and product (IV).

The nitro compound (IV) possesses interesting properties: it burns readily without melting.

LITERATURE

1. K. H. MERTENS, *Ber.* **10**, 995 (1877).
2. W. MICHLER and F. SALATHÉ, *Ber.* **22**, 1790 (1889).
3. P. VAN ROMBURGH, *Rec. trav. chim.* **2**, 31, 103, 304 (1883); **3**, 392 (1884); **8**, 215 (1889).
4. C. E. CLARKSON, I. G. HOLDEN and T. MALKIN, *J. Chem. Soc.* **1950**, 1556.
5. H. H. HODGSON and J. TURNER, *J. Chem. Soc.* **1942**, 584.
6. K. H. MERTENS, *Ber.* **19**, 2123 (1886).
7. P. VAN ROMBURGH, *Rec. trav. chim.* **5**, 240 (1886); **6**, 251 (1887).
8. T. URBAŃSKI and A. SEMEŃCZUK, *Bull. Acad. Polon. Sci., Cl. III*, **5**, 649 (1957).

9. A. SEMEŃCZUK and T. URBAŃSKI, *Bull. Acad. Polon. Sci., Cl. III*, **6**, 309 (1958).
10. P. P. SHORYGIN and A. V. TOPCHIYEV, *Zh. obshch. khim.* **8**, 981 (1938).
11. K. J. P. ORTON, *Ber.* **40**, 370 (1907).
12. F. M. LANG, *Compt. rend.* **227**, 1384 (1948).
13. J. ISSOIRE and G. BURLET, *Mém. poudres* **39**, 65 (1957).
14. W. E. GARNER and C. L. ABERNETHY, *Proc. Roy. Soc. (London)* **99**, 213 (1925).
15. P. VAN ROMBURGH, *Rec. trav. chim.* **6**, 251 (1887); **8**, 273 (1889).
16. P. VAN ROMBURGH and SCHEPERS, *Verslag Gewone Vergader. Afdel. Natuurk., Nederland. Akad. Wetenschap.* **22**, 293 (1913).
17. L. DESVERGNES, *Chimie et industrie*, **24**, 785, 1304 (1930).
18. S. BOGDAŁ and D. SMOLEŃSKI, *Bull. Inst. Appl. Chem.* **10**, 3 (1956); *Vlith Jubilee Congress of the Polish Chem. Soc.*, Warsaw, 1959, p. 180.
19. W. MICHLER and S. PATTISON, *Ber.* **14**, 2161 (1881).
20. P. VAN ROMBURGH, *Rec. trav. chim.* **41**, 38 (1922).
21. T. L. DAVIS, *The Chemistry of Powder and Explosives*, J. Wiley, New York, 1943.
22. W. C. CRATER, U.S. Pat. 1996146 (1936).
23. W. H. RINKENBACH and E. D. REGAD, U.S. Pat. 1940811 (1934).
24. C. A. TAYLOR and W. H. RINKENBACH, *J. Am. Chem. Soc.* **45**, 104 (1923).
25. A. F. BELAYEV and N. MATYUSHKO, *Dokl. Akad. Nauk. SSSR* **30**, 629 (1941).
26. W. E. GARNER and C. L. ABERNETHY, *Proc. Roy. Soc. (London)* **99**, 213 (1921).
27. H. KAST, *Spreng- u. Zündstoffe*, Vieweg & Sohn, Braunschweig, 1921.
28. A. M. PRENTISS, *Army Ordnance* **4**, 242 (1923/24); *Phys. Ber.* **5**, 1469 (1924).
29. W. H. RINKENBACH, *Kirk & Othmer Encyclopedia of Chemical Technology*, Interscience, New York, **6**, 51 (1951).
30. T. L. DAVIS and C. F. H. ALLEN, *J. Am. Chem. Soc.* **36**, 1063 (1924).
31. A. P. N. FRANCHIMONT and H. J. BACKER, *Rec. trav. chim.* **32**, 327 (1913).
32. R. C. FARMER, *J. Chem. Soc.* **117**, 1432, 1603 (1920).
33. L. DESVERGNES, *Mém. poudres* **19**, 217 (1922).
34. N. N. YEFREMOV and A. TIKHOMIROVA, *Ann. inst. anal. phys. chim. (U.S.S.R.)* **3**, 269 (1926); **4**, 92 (1928); A. BOGOYAVLENSKII and N. N. YEFREMOV, *ibid.*, **3**, 299 (1926).
35. N. N. YEFREMOV and O. K. KHAIBASHEV, *Ann. inst. anal. phys. chim. (U.S.S.R.)* **17**, 130 (1949).
36. M. GIUA, *Gazz. chim. ital.* **45**, II, 32 (1915).
37. C. A. TAYLOR and W. H. RINKENBACH, *Ind. Eng. Chem.* **15**, 73 (1923).
38. C. N. HINSHELWOOD, *J. Chem. Soc.* **120**, 721 (1921).
39. C. F. VAN DUIN, Thesis, Utrecht, 1918.
40. T. URBAŃSKI and M. SCHUCK, unpublished.
41. A. J. B. ROBERTSON, *Trans. Faraday Soc.* **44**, 667 (1948).
42. K. SZYC-LEWAŃSKA, unpublished.
43. S. Z. ROGINSKII and A. YA. LUKIN, *Acta physicochim. U.S.S.R.* **2**, 385 (1935).
44. F. LENZE, *Jahresber. Mil. Vers. Amt.* **2**, 6 (1895); **3**, 54 (1895); **4**, 10 (1897); F. LENZE and H. KAST, *ibid.* **6**, 21 (1899).
45. A. HAID and A. SCHMIDT, *Z. ges. Schiess- u. Sprengstoffw.* **26**, 253, 293 (1931).
46. T. CARLTON SUTTON, *Trans. Faraday Soc.* **34**, 992 (1938).
47. J. MARSHALL, *Ind. Eng. Chem.* **12**, 336 (1920).
48. M. A. COOK, *The Science of High Explosives*, Reinhold, New York, 1958.
49. H. SELLE, *Jahresber. Chem.-Techn. Reichsanstalt* **8**, 121 (1929).
50. R. ROBERTSON, *J. Chem. Soc.* **119**, 1 (1921).
51. A. KOEHLER, according to L. DESVERGNES, *Mém. poudres* **19**, 217 (1922).
52. E. JONES and D. MITCHELL, *Nature* **161**, 98 (1948).
53. K. K. ANDREYEV, *Thermal Decomposition and Burning of Explosives* (in Russian), Gosenergoizdat, Moskva-Leningrad, 1957.

54. F. MARTIN, *Über Azide u. Fulminate* (Habilitationsschrift), Darmstadt, 1913.
55. W. TAYLOR and W. C. COPE, U.S. Bureau of Mines Techn. Paper 145 (1916); *J. Soc. Chem. Ind. (London)* **35**, 1181 (1916).
56. H. B. TROUP, *Brit. J. Ind. Med.* **3**, 20 (1946).
57. L. J. WITKOWSKI, C. N. FISCHER and H. D. MURDOCK, *J. Amer. Med. Assoc.* **119**, 17 (1942).
58. A. M. SOKOLOV, *Manual of Manufacture of Explosives*, Ushakov and Lebedev (Ed.), (in Russian), Goskhimizdat, Moskva-Leningrad, 1934.
59. C. J. BAIN, *Army Ordnance* **6**, 435 (1925/26).
60. I.G. Farbenindustrie Manufacture of Intermediates for Dyestuffs, BIOS Final Report No. 986, Part II.
61. G. DESSEIGNE, *Mém. poudres* **28**, 156 (1938).
62. P. VAN ROMBURGH, *Rec. trav. chim.* **3**, 414 (1884).
63. Technical Records of Explosives Supply 1914-1918 No. 2; Manufacture of TNT, p. 25, HMSO, London, 1920.
64. P. VAN ROMBURGH, *Rec. trav. chim.* **8**, 274 (1889).
65. J. J. BLANKSMA, *Rec. trav. chim.* **21**, 254 (1902).
66. C. F. VAN DUIN and B. C. R. VAN LENNEP, *Rec. trav. chim.* **39**, 145 (1920).
67. J. J. BLANKSMA, *Rec. trav. chim.* **21**, 266 (1902).
68. P. VAN ROMBURGH, *Rec. trav. chim.* **7**, 1 (1888).
69. J. J. BLANKSMA, *Rec. trav. chim.* **27**, 23 (1908).
70. T. URBAŃSKI, *Roczniki Chem.* **17**, 591 (1937).
71. L. MÉDARD, *Mém. poudres* **33**, 45 (1951).
72. T. L. DAVIS, U.S. Pat. 1607059 (1926).
73. P. VAN ROMBURGH, *Rec. trav. chim.* **6**, 368 (1887).
74. S. GALINOWSKI and T. URBAŃSKI, *J. Chem. Soc.* **1948**, 2169.
75. G. M. BENNETT, *J. Chem. Soc.* **115**, 576 (1919).
76. R. F. B. COX, U.S. Pat. 2125221 (1938).
77. E. C. MORAN, U.S. Pat. 1560427 (1925).
78. R. V. LE CLARK, *Ind. Eng. Chem.* **25**, 1386 (1933).
79. P. VAN ROMBURGH, *Chem. Weekblad* **31**, 728 (1934).
80. E. HERZ, Ger. Pat. 530704 (1930); Brit. Pat. 367713 (1930).
81. R. V. LE CLARK, *Ind. Eng. Chem.* **26**, 554 (1934).
82. A. SEMEŃCZUK, *Biul. WAT* **5**, XXII, 58 (1956).
83. H. A. BRUSON and C. W. MAC MULLEN, *J. Am. Chem. Soc.* **63**, 270 (1941).
84. J. URBAŃSKI and T. URBAŃSKI, *Bull. Acad. Polon. Sci., sér. chim.* **6**, 307 (1958); *Roczniki Chem.* **33**, 693 (1959).
85. ULRICH, according to G. SCHULTZ, *Farbstofftabellen*, No. 1040, p. 451, Akademische Verlagsges., Leipzig, 1931; Meister, Lucius & Brüning (Höchst), Ger. Pat. 38979 (1886).
86. R. GNEHM, *J. prakt. Chem.* **76**, 407 (1907).
87. T. URBAŃSKI, K. SZYC-LEWAŃSKA and P. KALINOWSKI, *Bull. Acad. Polon. Sci., sér. chim.* **7**, 147 (1959).

CHAPTER IV

HETEROCYCLIC NITRAMINES

CYCLONITE

CYCLONITE or cyclo-trimethylenetrinitramine (1,3,5-trinitrohexahydro-sym-triazine, 1,3,5-trinitro-1,3,5-triazacyclohexane) is a very

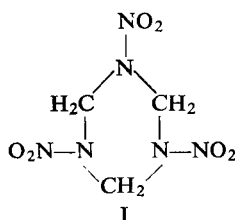

important explosive. It is also known as Hexogen, RDX and T4. It achieved great importance during World War II as a constituent of many explosive mixtures from which a high power was required. Cyclonite was used in detonators and primers, and in detonating gains or boosters replacing tetryl. It was used extensively in mixtures with trinitrotoluene, as a so-called hexolite, semi-liquid, fusible explosive. Mixtures of trinitrotoluene and cyclonite with aluminium, and plastic explosives containing cyclonite were also used. Some of these contained ammonium nitrate.

Cyclonite was first prepared by Lenze [1]. The method of manufacture by the nitration of hexamethylenetetramine nitrate with nitric acid is described in Henning's patent [2] of 1899.

The author did not cite the product as an explosive — he recommended its use in medicine — but in later patents [3] he proposed the use of cyclonite in the manufacture of smokeless propellant. In 1921 Herz [4] modified Henning's method by nitrating hexamethylenetetramine itself, not its nitrate. Hale [5] described in detail the preparation of cyclonite by nitrating hexamethylenetetramine, and reported its explosive properties.

Investigations carried out at that time revealed the outstanding value of cyclonite as an explosive: its high chemical stability, which is not much lower than that of aromatic nitro compounds, and its great explosive power, which considerably surpasses that of aromatic nitro compounds, such as trinitrotoluene and picric acid.

PETN, which has about the same power, compares unfavourably with cyclonite, the latter being less sensitive to mechanical stimulus and having a higher chemical stability.

Thus during the inter-war period in countries with well developed chemical industries, and in particular in Germany, Britain and U.S.S.R., new, more economical and safer methods of cyclonite preparation were worked out. During World War II similar work was also carried on in the United States and Canada. German methods became generally known after the war. Since it was found that the methods elaborated in Britain, Canada and the United States were not essentially different from those employed in Germany, the majority of them were also published. These methods consist in principle of synthesizing cyclonite from various forms of formaldehyde (e.g. paraformaldehyde, hexamethylenetetramine or simple Schiff bases) and from ammonium nitrate or hexamethylenetetramine nitrate as a source of nitramino groups. They will be discussed in detail further on.

During World War II Germany produced 7000 tons of cyclonite a month; by the end of the war the United States was manufacturing about 15,000 tons a month.

PHYSICAL PROPERTIES

Cyclonite is a white substance, crystallizing in the orthorhombic system (Terpstra [6]; Hultgren [7]). The refractive indexes n_D for different axes are: $\alpha=1.5775$; $\beta=1.5966$; $\gamma=1.6015$. The melting points reported by various authors are 202°C, 203.5°C, 204.1°C and 206–207°C.

The specific heat of cyclonite is 0.30 cal/g°C, its heat of combustion 2285 kcal/kg, and its heat of formation — 96 kcal/kg, i.e. $-\Delta H_f = -21.3$ kcal/mole. Cyclonite is therefore an endothermic compound and this is one of the factors which render it so highly explosive.

The vapour pressure of cyclonite at various temperatures (according to Edwards [8]) is:

at 110.0°C	4.08×10^{-5} cm Hg
at 121.0°C	1.04×10^{-4} cm Hg
at 131.4°C	2.57×10^{-4} cm Hg
at 138.5°C	4.00×10^{-4} cm Hg

These figures correspond with the empirical equation:

$$\log p = 10.87 - 5850 \frac{1}{T}$$

where p denotes vapour pressure in cm Hg, and T is the absolute temperature.

Cyclonite crystals have a specific gravity of 1.820. When compressed the densities given in Table 15 are obtained. A density of 1.73 may be obtained under a pressure of 2000 kg/cm² provided that a desensitizer (e.g. wax) is added to reduce friction.

Cyclonite is practically insoluble in water. Majrich [9] reports its solubility as 0.01% at 0°C and 0.15% at 100°C. Cyclonite is soluble in concentrated nitric acid. In sulphuric acid at concentrations above 70% solution is accompanied by decomposition.

TABLE 15

Pressure kg/cm ²	Density
750	1.46
1000	1.50
1250	1.54
1500	1.56
1750	1.58
2000	1.60

In most organic liquids cyclonite dissolves with difficulty. The best solvent, from which it can be crystallized, is acetone. Table 16 contains solubility data for cyclonite (in g per 100 g of solution).

TABLE 16

SOLUBILITY OF CYCLONITE IN ORGANIC SOLVENTS (ACCORDING TO T. URBANSKI AND KWIATKOWSKI [10])

Temperature °C	Methyl alcohol	Ethyl alcohol	Isoamyl alcohol	Ethyl ether	Acetone	Benzene	Toluene	Carbon tetra-chloride
0	0.140	0.040	0.020	—	4.18	—	0.016	—
10	0.180	0.070	0.023	0.050	5.38	0.020	0.018	—
20	0.235	0.105	0.026	0.055	6.81	0.045	0.020	—
30	0.325	0.155	0.040	0.075	8.38	0.055	0.025	—
34	—	—	—	0.090	—	—	—	—
40	0.480	0.235	0.060	—	10.34	0.085	0.050	—
50	0.735	0.370	0.110	—	12.80	0.115	0.085	0.005
58	—	—	—	—	15.27	—	—	—
60	1.060	0.575	0.210	—	—	0.195	0.125	0.007
64.5	1.250	—	—	—	—	—	—	—
70	—	0.880	0.320	—	—	0.300	0.210	0.015
78.1	—	1.180	—	—	—	—	—	—
79.5	—	—	—	—	—	0.400	—	—
80	—	—	0.500	—	—	—	0.295	—
90	—	—	0.850	—	—	—	0.465	—
100	—	—	1.325	—	—	—	0.640	—
110	—	—	1.900	—	—	—	0.980	—
120	—	—	2.990	—	—	—	—	—
131.6	—	—	3.870	—	—	—	—	—

The solubility of cyclonite (in g per 100 g of solution) in other solvents as reported by various other authors is given in Table 17. It is insoluble in carbon disulphide, soluble in hot aniline and phenol.

T. Urbański and Rabek-Gawrońska [11] found that cyclonite dissolves in molten, highly-nitrated aromatic hydrocarbons, substituted urea derivatives, and camphor to form eutectics of the composition given in Table 18. It is almost insoluble in molten diphenylamine.

TABLE 17

SOLUBILITY OF CYCLONITE IN OTHER ORGANIC SOLVENTS

Temperature °C	Chloro- form	Methyl acetate	Ethyl acetate	Cyclo- hexa- none	Nitro- benzene	Pyridine	Mesityl oxide
20	0.008	2.95	0.517	—	—	1.60	—
25	—	—	—	12.7	1.5	—	3
50	—	6.0	—	—	—	—	—
97	—	—	—	27	12.4	—	12

TABLE 18

EUTECTIC MIXTURES WITH CYCLONITE

Second component	Content of cyclonite in eutectic mixture %	Freezing point of eutectic °C
<i>p</i> -Nitrotoluene	about 0.5	50.4
<i>p</i> -Nitroanisole	about 0.5	50.9
α -Nitronaphthalene	about 1.5	55.4
<i>m</i> -Dinitrobenzene	8	85.5
α -Trinitrotoluene	2.5	78.6
1,3,5-Trinitrobenzene	about 3	113.8
Picric acid	12	112.9
Tetryl	10	118.1
<i>sym</i> -Dimethyldiphenylurea	17	112.4
<i>sym</i> -Diethyldiphenylurea	3	70.4
Camphor	22	137.5

CHEMICAL PROPERTIES

Herz [4] first suggested a hypothetical structural formula for cyclonite. This formula is now considered to be correct since it has been confirmed by a number of methods of synthesis discussed later.

It has been established that cyclotrimethylenetrinitrosoamine (II), a product of the nitrosation of hexamethylenetetramine, is oxidized with nitric acid (about 40%) to cyclonite (I). This confirms the structure of cyclonite.

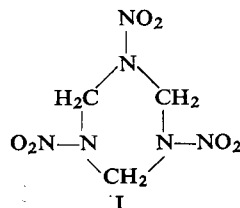
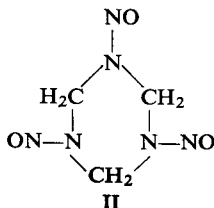

It also provides a method of obtaining a chemically pure preparation, free from octogen. The reaction proceeds stepwise. It will be discussed more fully on p. 123 (Brockmann, Downing and Wright [12]).

However, attempts to prepare cyclonite from substances containing a sym-triazine ring, e.g. from N,N',N''-trichloro-cyclotrimethylenetriamine (III) (obtained by Delépine [13], by the action of hypochlorous acid on hexamethylenetetramine) were a failure.

An attempt to prepare cyclonite by reacting the substance (III) with silver nitrite also failed, as it resulted in total decomposition of the molecule.

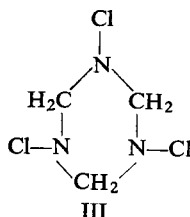

According to Vernazza [14] cyclonite is decomposed at 25°C by concentrated sulphuric acid, to form nitrogen and formaldehyde.

*The reaction is said to proceed as follows:

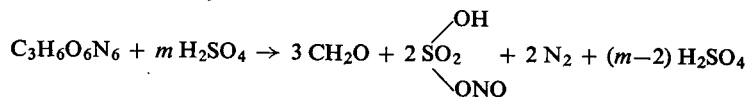

This reaction indicates why the results of analysis of cyclonite in the nitrometer are too low.

Šimeček [15] doubted the correctness of the Vernazza equation and believed that the decomposition of cyclonite by concentrated sulphuric acid at 20–40°C may be expressed by the following empirical equation:

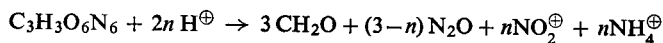

Šimeček suggested the following mechanism for the decomposition reaction:

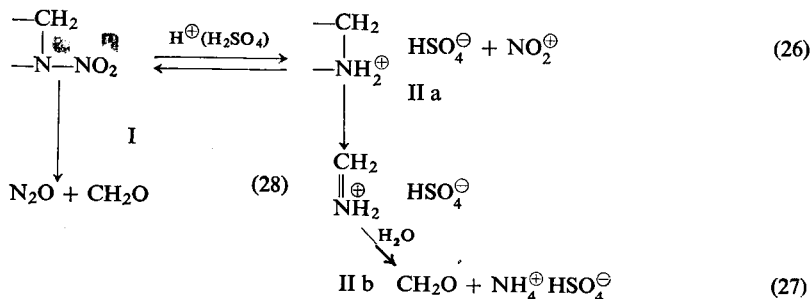

According to reaction (26) concentrated sulphuric acid liberates the nitronium ion from cyclonite (as from nitroguanidine, as reported on p. 26). Cyclotrimethylenetriamine sulphate (II) is formed which is then converted to a Schiff's base sulphate.

The latter is hydrolysed to formaldehyde and ammonium sulphate according to reaction (27). Simultaneously reaction (28) takes place, involving those molecules of cyclonite unaffected by sulphuric acid. Reaction (28) results in the formation of nitrous oxide and formaldehyde.

Šimeček also came to the conclusion that N_2O is not liberated in the nitrometer during the decomposition of cyclonite since formaldoxime $CH_2=NOH$ is formed in the presence of formaldehyde hence the analytical results are low.

It should be noted that the presence of water in the sulphuric acid promotes the decomposition of cyclonite. This is particularly easy when the acid contains 1–15% of water. In a strictly anhydrous medium the course of the reaction is much milder. Nitric acid which contains SO_3 does not cause the decomposition of cyclonite.

According to Somlo [16] the action of a 4% solution of NaOH at $60^\circ C$ produces the total decomposition of cyclonite after 5 hr. Somlo also studied the decomposition of cyclonite by concentrated sodium hydroxide and found it to be complete within 2–4 hr at $60^\circ C$. Among the decomposition products he detected nitrates, nitrites, organic acids, ammonia, nitrogen, formaldehyde and hexamethylenetetramine.

Epstein and Winkler [17] reported a preliminary examination of the kinetics of cyclonite decomposition proceeding by a homogeneous phase in acetone solution.

The kinetics of decomposition of cyclonite in an alkaline medium of sodium methoxylate or lithium in a solution of methyl alcohol within the temperature range $19.0\text{--}44.93^\circ C$ was investigated in detail by W. H. Jones [18]. He studied the course of the reaction by determining the concentration of NO_2^\ominus ion with chloramine T, by titrating with acid in the presence of various indicators and by determining the unaltered cyclonite polarographically. On the basis of these analyses Jones drew up four equations, according to which the decomposition reaction proceeds under the influence of a methoxyl anion (OCH_3^\ominus , A, B and C denote hypothetical intermediate products)

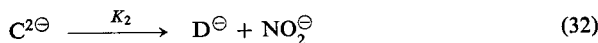
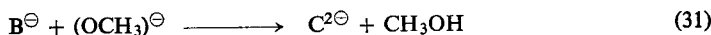
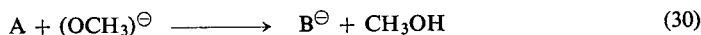
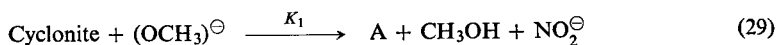

Reactions (30) and (31) proceed very rapidly; K_1 and K_2 are the constants of reactions (29) and (32); $C^{2\ominus}$ is a strong base; B^\ominus and D^\ominus are weaker bases.

The equation for the rate of reaction as deduced by Jones is:

$$\frac{dx}{dt} = K_1(a - 3x_1)(b - x_1) + K_2(x_1 - x_2) \quad (33)$$

where a denotes the initial concentration of $(OCH_3)^\ominus$ ions, b the initial concentration of cyclonite.

After time t :

x is the total molar concentration of the NO_2^\ominus ion; x_1 the molar concentration of NO_2^\ominus from reaction (29); x_2 the molar concentration of NO_2^\ominus from reaction (32). Jones also deduces the following equations:

$$-\frac{dR}{dt} = K_1 R(a - 3b + 3R) \quad (34)$$

$$-\frac{dZ}{dt} = K_1 Z(3b - a + Z) \quad (35)$$

$$-\frac{dY}{dt} = K_1 \frac{1}{2} (3Y - a)(Y + 2b - a)^2 \quad (36)$$

where after time t :

R is the molar concentration of cyclonite; Z the molar concentration of $(\text{OCH}_3)^\ominus$ (determined by nitration in the presence of phenolphthalein); $Y = Z + C$, i.e. total basicity (determined by titration in the presence of bromothymol blue); C the molar concentration of the $\text{C}^{2\ominus}$ ion.

The nature of the intermediate products of reaction was not determined by Jones. Instead, he suggested that the intermediate product A is formed from cyclonite by the elimination of HNO_2 and has the structure given below. He derived the hypothetical structure of the ions B^\ominus and C^\ominus in a similar manner.

Cyclonite is more stable to heat than penthrite and at a temperature above the melting point of tetryl, e.g. at 140°C , also shows greater stability than the latter.

According to Avogadro [19] the ignition temperature of cyclonite is 215°C (this author reports 185°C for penthrite). T. Urbański and Pillich [20] found the following values for ignition temperatures:

tetryl	203°C
penthrite	209°C
cyclonite	229°C

Heating began at 150°C , the rate of temperature rise was $10^\circ/\text{min}$. Ignition after a 5 sec delay occurred at 260°C .

Many authors, viz.: Majrich [9], Tonegutti [21] and Haid, Becker and Dittmar [22] point out that cyclonite is more stable than penthrite and tetryl.

A. J. B. Robertson [23] found that the decomposition of cyclonite at a temperature above its melting point (between 213 and 299°C) proceeds as a first order reaction. At 213°C , half the substance decomposes in 410 sec, and at 299°C in 0.25 sec. The gaseous decomposition products contain chiefly N_2 , N_2O , NO , CO and CO_2 . According to A. J. B. Robertson the activation energy E of the thermal decomposition of cyclonite at these temperatures is 47,500 cal, $\log B = 18.5$. The reaction rate in the liquid phase is approximately ten times greater than in the solid phase (below the melting point.)

T. Urbański and Krawczyk [24] studied the stability of cyclonite alone and in mixture with trinitrotoluene and found that:

(1) Samples of cyclonite when heated for 62 hr at 120°C, or for 36.5 hr at 110°C and subsequently for 60 hr at 120°C, contained no acidic decomposition products.

(2) In the Taliani test at 134.5°C cyclonite behaves like tetryl, i.e. it gives a pressure of 11.5 mm Hg after 24 hr heating, as compared with trinitrotoluene which gives 16 mm Hg.

(3) A mixture of 80% cyclonite with 20% trinitrotoluene decomposes somewhat faster, after 24 hr producing a pressure of 39 mm Hg, possibly due to the fact that the cyclonite is partly molten. In spite of this result the mixture should be considered more stable than tetryl.

According to Tabouis, Ortigues and Aubertein [25] cyclonite which has already been subjected to the Abel heat test at 80°C, fails to withstand a repeated test, rapidly darkening a starch-iodide paper. In the authors' opinion this is caused by the presence of traces of nitric acid in the crystals. On heating, this acid is liberated from the crystals, causing the sample to fail when the test is repeated. Cyclonite which contains more than 0.035% of HNO₃ (which is the maximum content permitted by French specifications) may pass in the Abel test the first time. The authors suggest that the traces of nitric acid may be removed by boiling cyclonite in an autoclave at 140°C.

Majrich found that light has a negligible effect on cyclonite. T. Urbański and Malendowicz [26] reported that under the influence of ultra-violet irradiation cyclonite changes colour from white to pale yellow, but undergoes no other alteration. In particular, unlike nitric esters, neither NO, nor NO₂ is evolved from cyclonite.

EXPLOSIVE PROPERTIES

According to Avogadro [19] when exploded cyclonite decomposes with the evolution of CO, CO₂, H₂O, N₂ and an insignificant amount of H₂. This author found the composition of the explosion products (after cooling) to be as follows:

CO	25.22%
CO ₂	19.82%
H ₂ O	16.32%
H ₂	0.90%
N ₂	37.83%

Avogadro calculated theoretically and found experimentally the following constants:

heat of detonation	1390 kcal/kg
gas volume	910 l./kg
temperature of explosion	3380°C
specific pressure (<i>f</i>)	12,600 m

Other authors gave somewhat lower figures:

1370 kcal/kg	(Tonegutti [27])
1359.5 kcal/kg	(Médard [28])

The most extensive investigations were those of Apin and Lebedev [29]. They examined the heat of detonation and the gas volume at different densities. The heat of detonation increases from 1290 to 1510 kcal/kg and the gas volume falls from 730 to 630 l./kg when the density is increased from 0.50 to 1.78 g/cm³. The variation

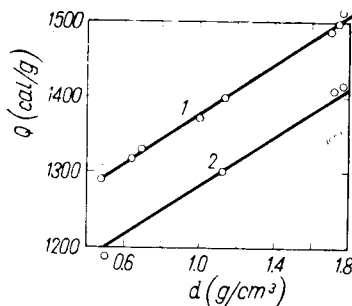
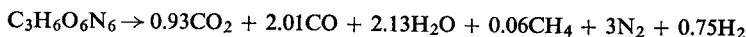

FIG. 11. Heat of detonation of cyclonite against the density of the charge, according to Apin and Lebedev [29]. Curve 1—liquid water, curve 2—gaseous water.

of the heat of detonation with density is linear, as shown in Fig. 11. The composition of the gaseous products also changed with density: increase in density was accompanied by an increase in carbon dioxide content.

Apin and Lebedev gave the following decomposition equation for cyclonite when the density was 1.10:



Data concerning the rate of detonation of cyclonite reported by various authors are tabulated below (Table 19).

The values are somewhat higher than those of penthrite.

TABLE 19
RATE OF DETONATION OF CYCLONITE (m/sec)

Density of loading	Kast [31]	T. Urbański and Galas [32]	Laffitte and Parisot [33]	Cook [34]
0.80	—	—	5000	—
0.92	—	—	5500	—
1.0	—	—	—	6080
1.05	—	—	6000	—
1.35	—	7400	—	—
1.40	—	7550	—	—
1.45	—	7705	—	—
1.70	8380	—	—	—

The lead block expansion ranges from 450 to 520 cm³ according to different authors. The relative value taking picric acid as 100, is estimated at about 170.

Cyclonite is less sensitive to impact than penthrite.

The following figures, based on the investigations of T. Urbański [30], are characteristic of the sensitiveness of cyclonite and tetryl to impact.

The work required to cause:

is:	10% of explosions	50% of explosions
for penthrite	0.11 kg/cm ²	0.20 kg/cm ²
for cyclonite	0.14 kg/cm ²	0.22 kg/cm ²
for tetryl	0.56 kg/cm ²	0.92 kg/cm ²

According to other authors (e.g. Izzo [35]) the difference in sensitiveness between cyclonite and tetryl is insignificant: as the following drop test figures, using a 2 kg weight, indicate: 30–32 cm for cyclonite, and 40 cm for tetryl.

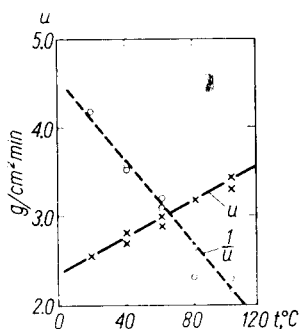

FIG. 12. Rate of burning of cyclonite against the initial temperature, according to Andreyev [36].

Andreyev [36] reports that powdered cyclonite of density about 0.9 burns in tubes of 5–6 mm dia., but when ignited at 20°C cyclonite usually goes out.

Under a pressure of 800 mm Hg the relationship between the mass rate of the burning of cyclonite and the temperature may be expressed by the equation:

$$u_m = -0.0107 + 0.000182 T_0$$

or

$$\frac{1}{u_m} = 43.92 - 0.0709 T_0$$

This relationship is illustrated in the diagram (Fig. 12).

The ease with which cyclonite can be detonated is markedly less than that of penthrite, but it is more easily detonated than tetryl.

TOXICITY

No explicitly harmful effect has been noticed among workers employed in the production or handling of cyclonite. Its toxicity appears to be considerably limited by its poor solubility which prevents it entering the blood stream.

Nevertheless the danger of poisoning is always present wherever workers have to deal with cyclonite dust, e.g. in drying and sifting operations and in measuring

the dry substance etc. It has been shown that breathing cyclonite dust gives rise to tonic-clonic spasms. These symptoms occur after a few days of breathing the dust. They last for 5–10 min, occurring intermittently and do not pass off at once when the patient is removed from the atmosphere containing cyclonite dust.

The toxicity of cyclonite has led to suggestions for its use as a "selective poison". For instance, it has been patented [37] as a rodenticide. According to the patent specification the lethal dose for rats is 20 mg. It is much less toxic for domestic animals and human being.

CYCLONITE MANUFACTURE

1. THE ACTION OF NITRIC ACID ON HEXAMINE

General information

The oldest and simplest method of preparing cyclonite is based on the introduction of hexamethylenetetramine (hexamine) into an excess of concentrated nitric acid, s. g. 1.50–1.52, free of nitric oxides, at 25–30°C, thereafter pouring the whole into cold water.

According to Hale [5] the reaction may be represented by the following equation:

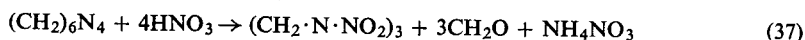

whereas Schnurr [38] formulates the reaction as follows:

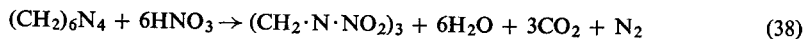

It appears however that the reaction proceeds according to both equations simultaneously since ammonium nitrate and formaldehyde are formed according to equation (37) and CO_2 , N_2 and water according to equation (38). Some of the methylene groups and nitrogen atoms of hexamine are therefore not utilized for the production of cyclonite. The nitration of hexamine with nitric acid requires from four to eight times the theoretical amount of nitric acid.

Apart from the main reactions (37) and (38), side reactions (39) and (40) also take place.

Reaction (39) is a hydrolysis of hexamine resulting in the formation of formaldehyde and ammonia, and reaction (40) consists of the oxidation of formaldehyde with nitric acid.

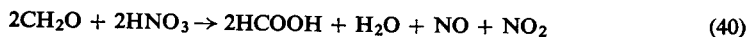

Apart from the side reactions (39) and (40), others may occur which also result in the formation of explosive substances other than cyclonite.

This may be explained by considering the nitration of hexamine with nitric acid as a stepwise degradation by nitrolysis, i.e. the nitration of amine involving the stepwise cleavage of the bond between the nitrogen and carbon atoms. According to Lambertson [39] this idea was first advanced by Linstead. The main work on this subject has been done by British [39] and Canadian [40] authors.

According to the investigations of Hirst, Carruthers *et al.* [41] and Vroom and Winkler [42], the action of nitric acid on hexamine dinitrate (IV) results in the formation of the substance (V) by nitrolysis.

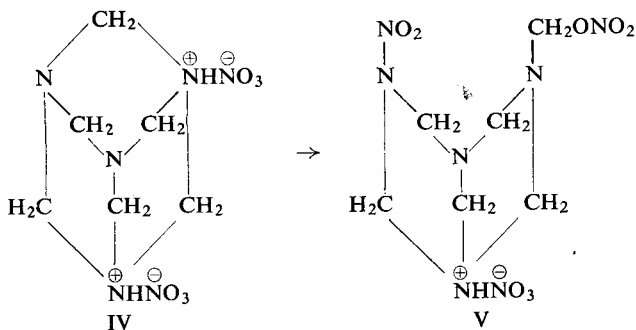

Alcohol groups are esterified with nitric acid. Further nitrolysis may cause the cleavage of N—C bonds. The experimental data (Wright and Myers [43]) indicate that the cleavage of bond *A* most probably occurs with the formation of the hypothetical compound (VI). In turn the latter may undergo nitrolysis at position *B* to form another hypothetical product (VII) [39, 40, 43, 44] and a known compound (VIII) [39, 40, 44], i.e.

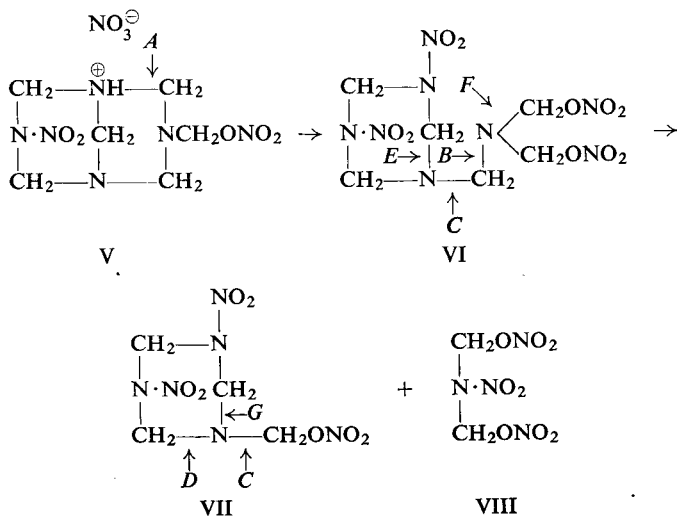

On nitrolysis of the bond *C* the compound (VII) finally gives cyclonite. If, however, the bond *D* is nitrolysed, a chain compound may be formed.

Another open-chain methylenenitramine may arise from the compound (VI), if the bounds *E* and *F* are nitrolysed. The compound isolated and identified as 1,9-dinitroxy-2,4,6,8-tetranitro-2,4,6,8-tetrazanonane (IX) is then formed:

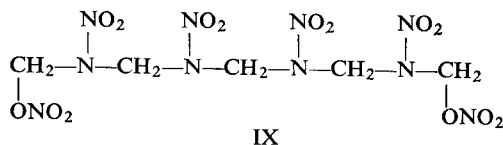

The formation of this substance is favoured by a low nitration temperature. It is unstable and highly sensitive to impact hence its presence in cyclonite is very undesirable.

According to Singh [45] under the influence of the nitracidic ion ($\text{H}_2\text{NO}_3^\oplus$), hexamethylenetetramine first undergoes hydrolysis identical to that leading to the formation of (VI). On hydrolysis the ion (VIa) would be formed or on further heterolysis the ion (VIb), then (VIc). The latter would undergo nitrolysis to form cyclonite, methylnitramine (VIIIa) and formaldehyde:

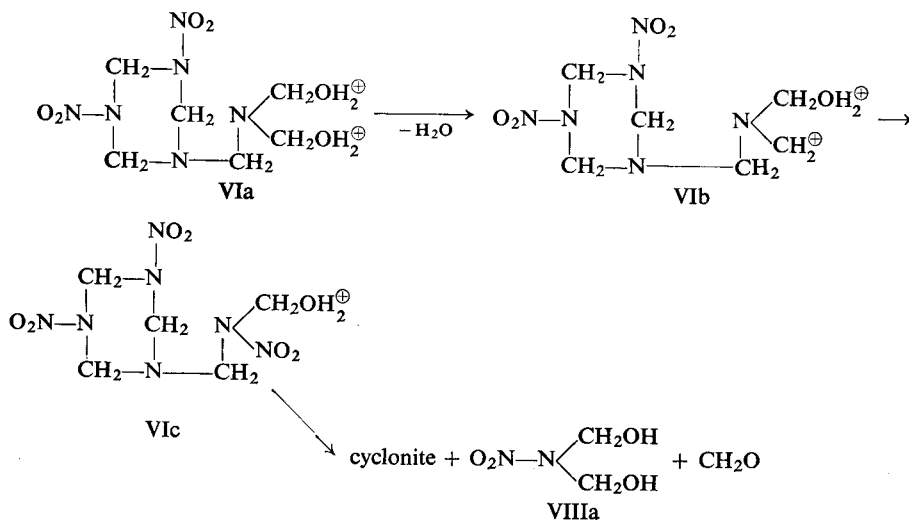

Among the reaction products a cyclic ether is also present to which the structure (X) is ascribed. It is possible that it arises either from the compound (VII) on nitrolysis of the two bonds *D* and *G* and the dehydration of the two alcohol groups so produced, or directly from the compound (VII) on a *sui generis* nitrolysis

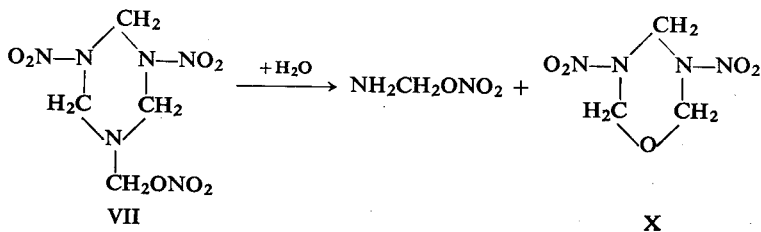

The compound (X) (3,5-dinitro-1-oxa-3,5-diazacyclohexane) dissolves in hot water and crystallizes from solution on cooling. Its melting point is 97°C.

Nitrolysis of the compound (V) may also lead to the formation of the substance (XI) containing an eight-membered ring, called octogen (HMX) (see p. 117) which always accompanies cyclonite, but slightly reduces its power.

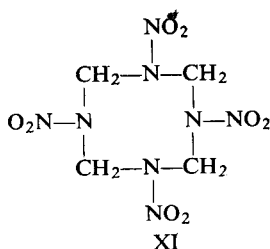

Evidence of the presence of the compound (V) in the intermediate products of nitration has been provided by Wright *et al.* [44] who found that the substance (XII) (1,5-endomethylene-3,7-dinitro-1,3,5,7-tetrazacyclo-octane, or 3,5-dinitro-1,3,5,7-tetrazabicyclo [3,3,1] nonane (DPT)) may be isolated in amount corresponding to 5–12% of the cyclonite by neutralization of the ammonia with spent acid.

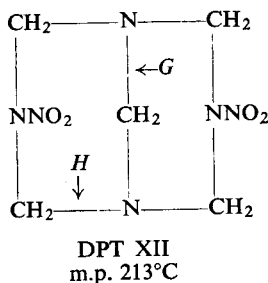

In turn this substance may undergo further nitrolysis which may lead, for example, to the compound (XI) described above while nitrolysis of the bonds *G* and *H* may yield the open-chain compound (IX), which is highly sensitive to impact, and therefore very undesirable.

According to Wright *et al.* [44] DPT can also yield 3,7-dinitro-3,7-diaza-1,5-dioxacyclo-octane (m.p. 263–264°C) under action of nitric acid (99%) and ammonium nitrate:

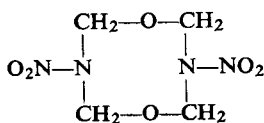

Wright *et al.* [46] pointed out that apart from the compound (VII) nitrolysis of hexamine may also lead to the transient formation of 1-di(hydroxymethyl)-amino-methyl-3,5-dinitro-1,3,5-triazacyclohexane (XIII) [(VI) is the dinitrate of (XIII)] through the nitrolysis of the bonds *K* and *M*:

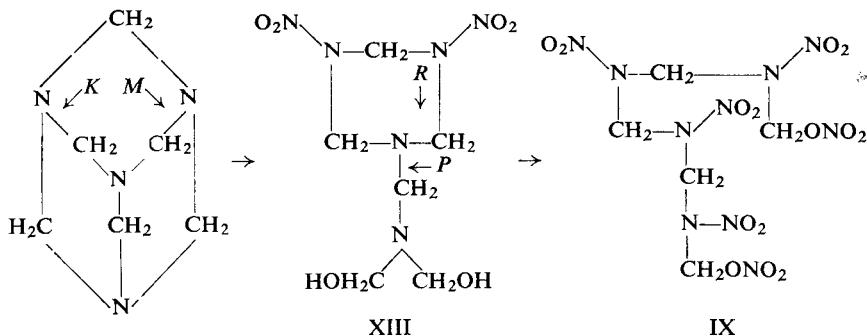

In Wright's opinion the existence of the transient compound, (XIII) is proved by the formation of substance (IX) which can be isolated from the products when cyclonite undergoes nitrolysis of the *P* and *R* bonds.

To protect the hydroxyl groups of the compound (VII) or (XIII) by acetylation Wright cooled a solution after nitrolysis to -55°C and then added acetic anhydride at a temperature below -25°C . Apart from cyclonite he isolated 1-acetoxy-7-nitroso-2,4,6-trinitro-2,4,6-triazaheptane (XIV). The addition of the solution from nitrolysis to acetic anhydride gave a diacetyl derivative: 1,7-diacetoxy-2,4,6-trinitro-2,4,6-triazaheptane (XV):

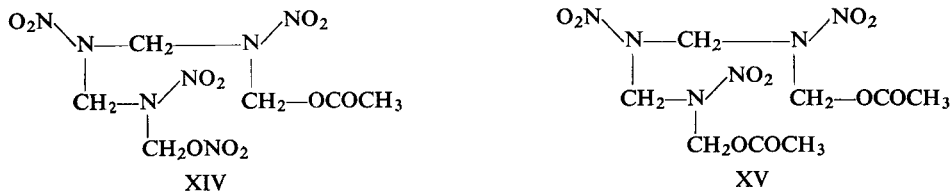

The nitration of cyclonite at very low temperatures also leads to the formation of a series of other compounds. Some of them are converted into cyclonite by the action of nitric acid at room temperature.

If the nitrolysis of hexamine dinitrate (IV) is conducted at a very low temperature, e.g. -40°C , then, as reported by Hirst *et al.* [41] it is not cyclonite which is formed, but a dinitrate of a dinitro derivative (Ia) (3,5-dinitro-3,5-diazapiperidinium nitrate):

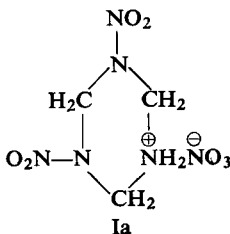

This was confirmed by Vroom and Winkler [42], who purified the substance (Ia) by dissolving it in anhydrous 75% nitric acid at -20°C , and then adding ice water at temperatures from -20 to -15°C . The purified substance has a melting point of $98-99^\circ\text{C}$.

The formation of this compound may be explained by the fact that at a low temperature nitrolysis at point *C* (p. 88) is completed to produce amine nitrate and alcohol (or its ester), hence the formation of compound (Ia).

The latter is unstable and undergoes decomposition in hot water with the evolution of formaldehyde, nitrous oxide and ammonium nitrate

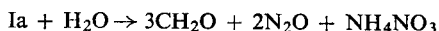

Cyclonite (I) can be prepared by the action of concentrated nitric acid or acetic anhydride on the compound (Ia) at room temperature. A N-acetyl derivative of dinitro compound (XXIX) (p. 116) is obtained by the action of acetic anhydride on the compound (Ia) in the presence of sodium acetate.

Vroom and Winkler found that under the influence of dilute alkali in an acetone or ethanol medium substance (Ia) gives a compound which, according to the investigations of Chute, McKay, Meen, Myers and Wright [47] is bicyclic (Ic).

Vroom and Winkler believed substance (Ia) to be an intermediate compound in the preparation of cyclonite by the nitrolysis of hexamine. This view was shown to be incorrect by Wright, Berman and Meen [46] who proved that the substance (Ia) cannot exist in the circumstances under which nitrolysis is usually carried out. Therefore Wright *et al.* suggested that the substance (Ia) arises when the reaction solution is diluted, viz. by the nitrolysis of the bonds *C* and *P* in the substances (VII) and (XIII) respectively.

According to Dunning and Dunning [48] the nitration of hexamine dinitrate at a temperature of about -30°C , followed by treatment of the product with ethyl alcohol permits the isolation of the product of nitrolysis of (VI) at point *B* in the form of an ether (Ib), m.p. 115°C and the compound (IXa) with a chain structure

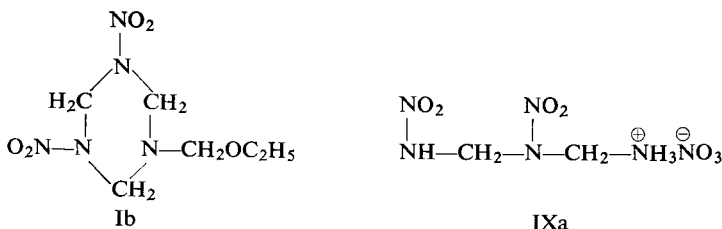

In addition, a bicyclic compound (Ic), m.p. 136°C , is present in the products of nitration at a low temperature, whereas nitration of the compound (Ib) with anhydrous nitric acid at a temperature of -30°C leads to the formation of an ether (Id)

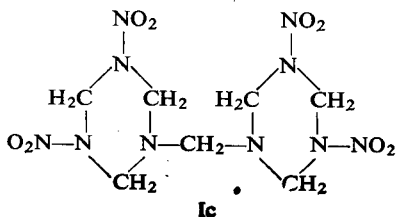

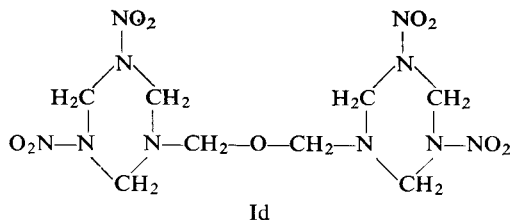

Cyclonite (I) arises from the nitration of compounds (Ib), (Ic) and (Id) at room temperature. The compound (IXa) also yields cyclonite on reaction with acetic anhydride and paraformaldehyde.

According to Karpukhin and Chetyrkin [49] the nitrolysis of hexamine may proceed with the formation of trihydroxymethylamine nitric ester (XVI):

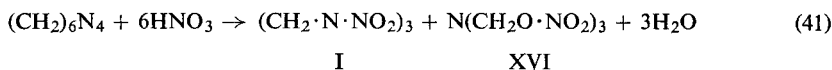

This may result from the nitrolysis of the compound (VI) at the bond C. This ester, like esters (VIII) and (IX), is unstable and readily decomposes. Finally, formaldehyde, split off from hexamine, may yield unstable methylene glycol nitrate (XVII) in the presence of anhydrous nitric acid.

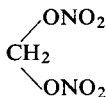

XVII

Owing to the presence of the unstable compounds (VIII), (IX), (XII) and (XIV), various reactions, mainly exothermic, occur in spent acid after the nitration of hexamine and the precipitation of cyclonite with water. Such reactions may lead to explosion hence it is not surprising that the first attempts to manufacture cyclonite, undertaken shortly after World War I, showed that the greatest difficulty in producing cyclonite lies in the danger created by the spent acid. The presence of all these products in spent acid makes its storage extremely dangerous. Some of these by-products may also contaminate cyclonite, lowering its stability.

Searching for ways of getting rid of these products, a method was worked out by which their decomposition was induced under strictly controlled conditions. Decomposition is caused, for instance, by pouring the mixture into hot water after nitration. The amount of water and the temperature are coordinated so that a concentration of 50–55% HNO₃ and a temperature of 70–90°C are maintained. Highly pure cyclonite is precipitated and NO₂ evolved from the decomposition of all unstable products. This is the so-called “degassing process”.

Owing to the side-reactions, the yield of nitration of hexamine does not exceed 75–80% (when calculated according to equation (37) or (38)); 110–119 kg of cyclonite can be obtained from 100 kg of hexamine.

Dunning, Millard and Nutt [50] studied the rate of nitration of hexamine with various concentrations of nitric acid, at 0°C and obtained the results, some of which are given in Table 20 and the graph in Fig. 13.

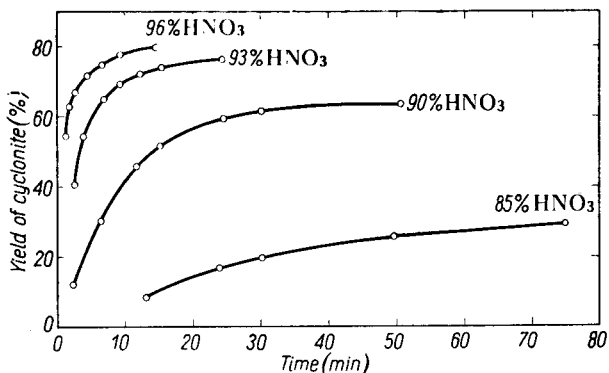

FIG. 13. Rate of nitration of hexamine at 0°C with various concentrations of nitric acid, according to Dunning, Millard and Nutt [50].

Vroom and Winkler [42] also examined the kinetics of the nitration of hexamine to cyclonite with various concentrations of nitric acid at 0°C and drew the following general conclusions:

(1) Maximum yield (about 40% of theoretical calculated on the formaldehyde used i.e. 80% of theoretical calculated on hexamine) can be obtained with all the concentrations of nitric acid used: 88–97% (Fig. 14). The minimum molar ratio of nitric acid to hexamine for maximum yield was found to increase from 26 : 1 with 97% acid to 110 : 1 with 88% acid.

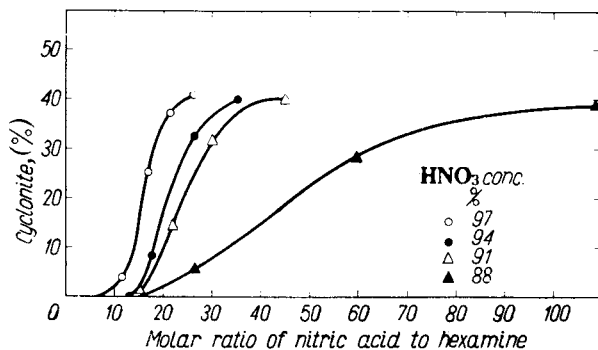

FIG. 14. Effect of nitric acid-hexamine ratio on final yield of cyclonite, according to Vroom and Winkler [42].

(2) The rate of nitrolysis increased rapidly as the molar ratio of nitric acid to hexamine was increased and continued to do so after the molar ratio was raised above that required for maximum yields (Fig. 15).

TABLE 20

Time, min	Concentration of HNO ₃				
	99%	96%	93%	90%	85%
	Yield of cyclonite [% of theoretical according to equation (37) or (38)]				
1.5	—	55.7	—	—	—
2.5	66.9	68.7	40.9	13.3	—
6.5	70.2	75.3	65.8	30.5	—
12	74.6	74.7	73.4	45.4	—
24	80.9	79.2	77.2	59.9	14.9
50	80.5	—	—	63.9	26.2
100	—	—	—	—	33.0
120	—	—	—	—	32.6

For 85–96% HNO₃ at 0°C the authors deduce the following empirical equation:

$$x = a \left(1 - e^{-\frac{t}{\tau}} \right)$$

According to the British data the heat of nitration of 1 kg of hexamine to cyclonite is 277 kcal/kg. According to the German data (Schnurr [38]) it is about 500 kcal/kg.

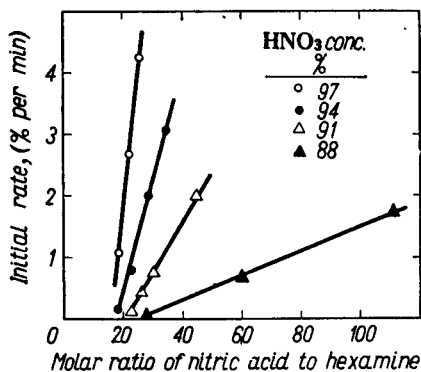
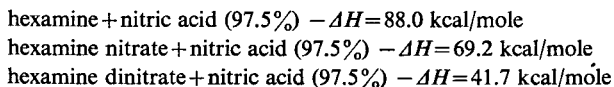

FIG. 15. Effect of nitric acid-hexamine ratio on initial rate of cyclonite formation at 0°C, according to Vroom and Winkler [42].

Gilpin and Winkler [51] report the following heats of nitration when cyclonite is prepared in different ways:



The formation of hexamine dinitrate from hexamine and nitric acid proceeds with a heat effect of $-\Delta H = 33.5$ kcal/mole; hexamine nitrate is also converted into dinitrate with a heat evolution of $-\Delta H = 15.7$ kcal/mole.

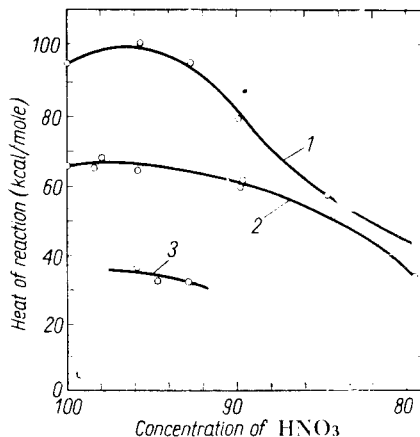

FIG. 16. 1—Nitration of hexamine at 20°C; 2—nitration of hexamine at -35.5°C; 3—nitration of hexamine dinitrate at -35.5°C, according to Dunning, Millard and Nutt [50].

On the basis of these figures the authors infer that hexamine dinitrate is formed at one stage of the nitration of hexamine to cyclonite.

Dunning, Millard and Nutt [50] published a graph (Fig. 16) showing the relation between the heat of nitration of hexamine to cyclonite and the concentration of

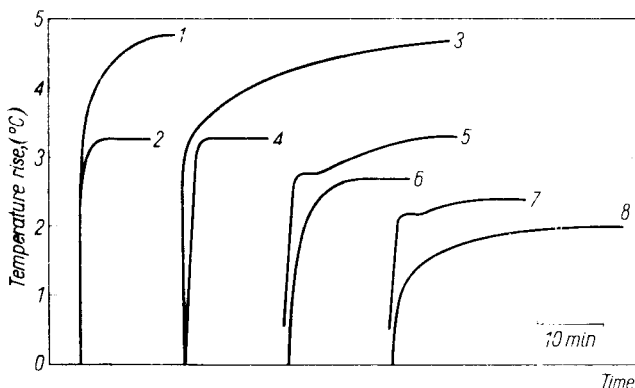

FIG. 17. Temperature changes during the nitration of hexamine with nitric acid, according to Dunning, Millard and Nutt [50]. 1—Anhydrous acid, nitration temperature 20°C; 2—anhydrous acid, nitration temperature -35.5°C; 3—96% acid, nitration temperature 20°C; 4—96% acid, nitration temperature -35.5°C; 5—90% acid, nitration temperature 20°C; 6—90% acid, nitration temperature -35.5°C; 7—85% acid, nitration temperature 20°C; 8—85% acid, nitration temperature -35.5°C.

nitric acid (within the range 80–99%). The graph expresses the integral heat of reaction in kcal per mole of hexamine at 20 and -35.5°C and of hexamine dinitrate at -35.5°C.

Temperature changes during nitration with various concentrations of acid at 20 and -35.5°C are shown on another graph (Fig. 17). Alterations in the shape of the curves are particularly marked when nitration proceeds at -35.5°C . During

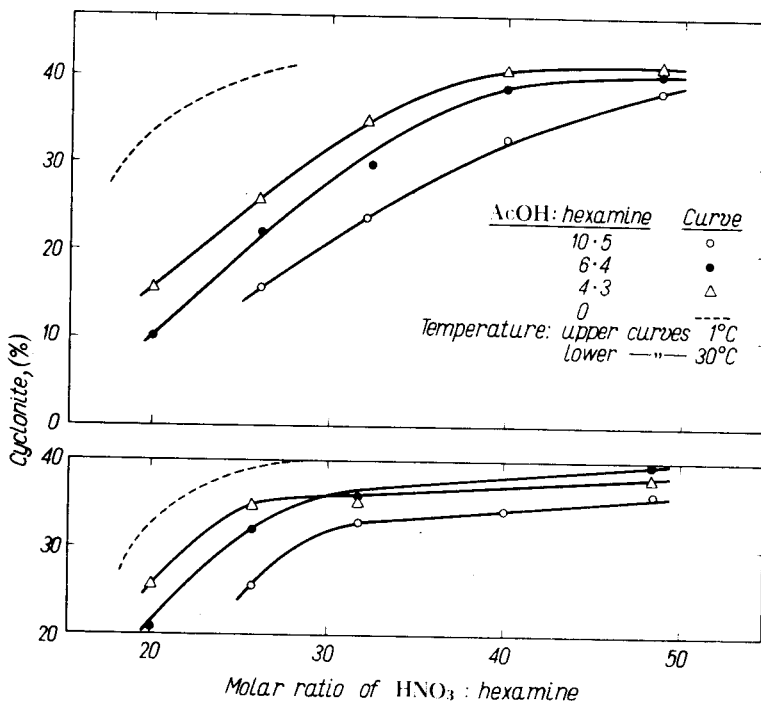

FIG. 18. Effect of nitric acid-hexamine ratio on final yield of cyclonite in acetic acid, according to Kirsch and Winkler [52].

nitration with 85% acid at -35.5°C the quantity of heat evolved corresponds to the formation of hexamine dinitrate only.

It appears that the reaction stops at this stage under these conditions.

Kirsch and Winkler [52] studied the influence of acetic acid on the nitrolysis of hexamine to cyclonite.

Experiments were made at 1°C and 30°C using various molar ratios of acetic acid/hexamine and varying the nitric acid/hexamine ratio between 26 : 1 and 81 : 1. Acetic acid was found to reduce the reaction rate and the yield of cyclonite (Fig. 18). However even with the most dilute solution of hexamine in acetic acid (molar ratio 10.5 : 1) the final yield of cyclonite approached a maximum of 80% at a molar ratio of nitric acid to hexamine of 48 : 1. In the absence of acetic acid this yield was obtained when the molar ratio was only 26 : 1. It appears that some of the nitric acid was used up in reacting with acetic acid and was therefore unavailable for nitrolysis.

There are various methods of utilizing the spent acid remaining from the nitration of hexamine. It is possible:

(1) To distil off nitric acid and to utilize the ammonium nitrate remaining after distillation for other purposes.

(2) To neutralize the acid with ammonia thus producing ammonium nitrate.

(3) To utilize the acid for preparing hexamine dinitrate and to nitrate the dinitrate, so obtained, to cyclonite. This method was studied by T. Urbański [53] who found, however, that the dinitrate is nitrated to cyclonite with some difficulty, part of the dinitrate remaining unchanged in the product. Since the dinitrate is not sufficiently stable, its presence in cyclonite is undesirable. Nevertheless, it may be used up for a synthesis of cyclonite by adopting a combined method, using hexamine dinitrate, ammonium nitrate and acetic anhydride. This will be discussed in later sections.

A factory at Avigliana (Italy) [54] used an entirely different method for processing and utilizing spent acid containing 45% HNO_3 : after the precipitation of cyclonite in the cold, the acid is subjected to distillation to recover the formaldehyde it contains. It is important to bear in mind that the distillation of acid which has not been passed through the "degassing process" is very dangerous even if carried out at a low temperature under vacuum (40°C is the recommended temperature).

British method

Nitration. In the production method employed in a factory at Bridgwater [55], the nitrator is fed continuously with nitric acid and hexamine and the product of nitration together with the acid flows off, also continuously.

The nitrator of stainless steel, 90 cm long, 32 cm wide, 80 cm high is divided by partition walls into three chambers. Each chamber contains a rotary high-speed stirrer. The first chamber is equipped with three concentric cooling coils of stainless steel 16 mm in diameter with a cooling surface of 1.85 m². The next two chambers contain single coils. Gases are expelled to the absorption towers through pipes leading from the lid of the nitrator. The pipe from the first chamber is equipped with a sight glass for observing the colour of the gases. If the colour is brown, the contents of the nitrator should be discharged forthwith into the drowning tank under the nitrator. Hexamine stored on the floor above is introduced by means of a screw conveyer into the first and second chambers of the nitrator through an inlet 5 cm in diameter. The feed mechanism is so arranged that the second chamber receives a quarter of the amount entering the first chamber. The rate at which the total amount of hexamine introduced into the nitrator may be varied is from 56 to 170 kg per hour. The weight of nitric acid introduced into the first chamber through a pipe 2.5 cm dia. is 12 times that of the hexamine.

The temperature in the first and second chambers of the nitrator should not be allowed to rise above 25°C. Control is achieved by intensive cooling. In the third chamber a temperature of 38°C is maintained by passing warm water through the coil.

An overflow for the acid and the reaction product is located in the third chamber about 58 cm from the bottom. The general view of the nitrator is shown in Fig. 19. A drowning tank is situated under the nitrator and connected to it by a pipe 7.5 cm

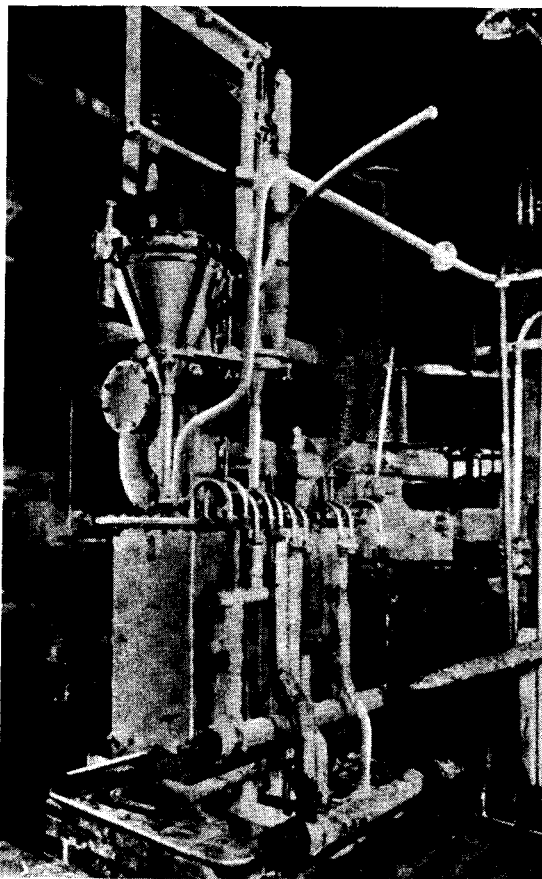

FIG. 19. General view of a continuous nitrator for the preparation of cyclonite [55].

in diameter. The tank is filled with an aqueous solution of urea which, on reaction with nitric oxides, considerably reduces the amount of brown fumes evolved when the nitrator's load is discharged into it.

Dilution. The liquid leaving the nitrator through the overflow passes to the diluter below. Here decomposition of unstable nitration products and precipitation of cyclonite takes place. The diluter (Fig. 21), of dimensions $265 \times 60 \times 115$ cm, is divided into four chambers, each containing a rotary stirrer (195 r.p.m.) and a heating coil. The diluter is filled continuously up to a level of 65 cm with 55% nitric acid. As the liquid containing more concentrated acid flows in from the nitrator water is added to maintain this concentration. A temperature of 75°C is maintained in the diluter by means of the heating coils.

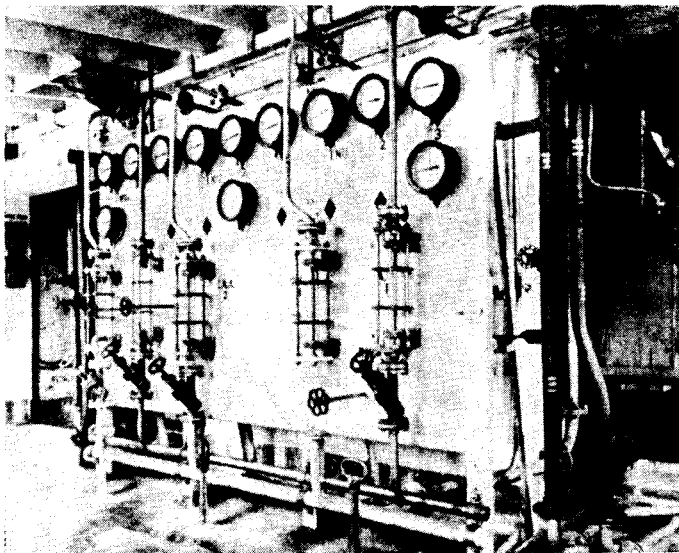

FIG. 20. Nitrator control panel. In the centre the drowning valve handle [55].

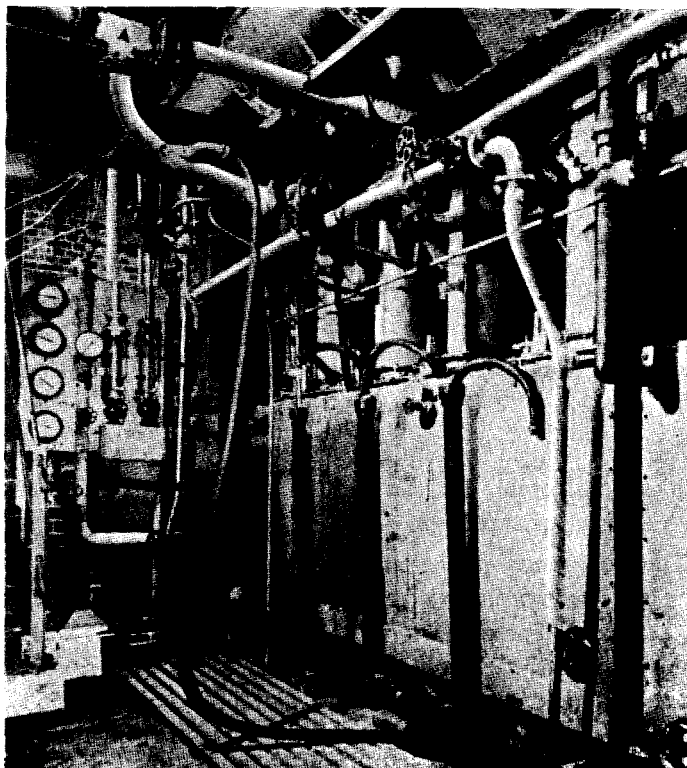

FIG. 21. General view of a diluter [55].

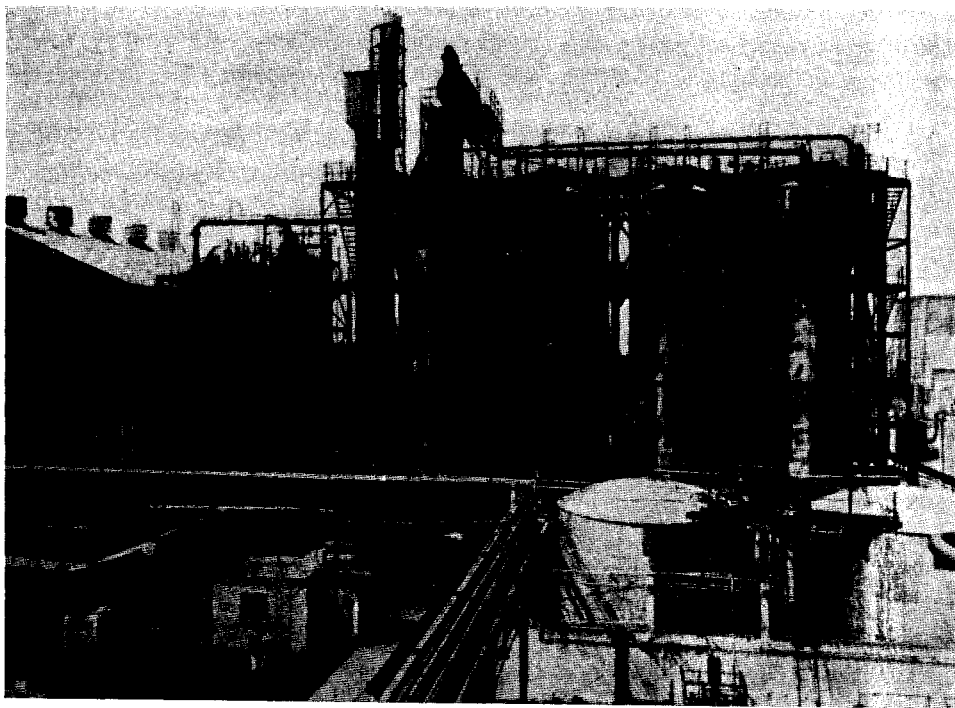

FIG. 22. Stainless steel absorption towers for nitric oxides [55].

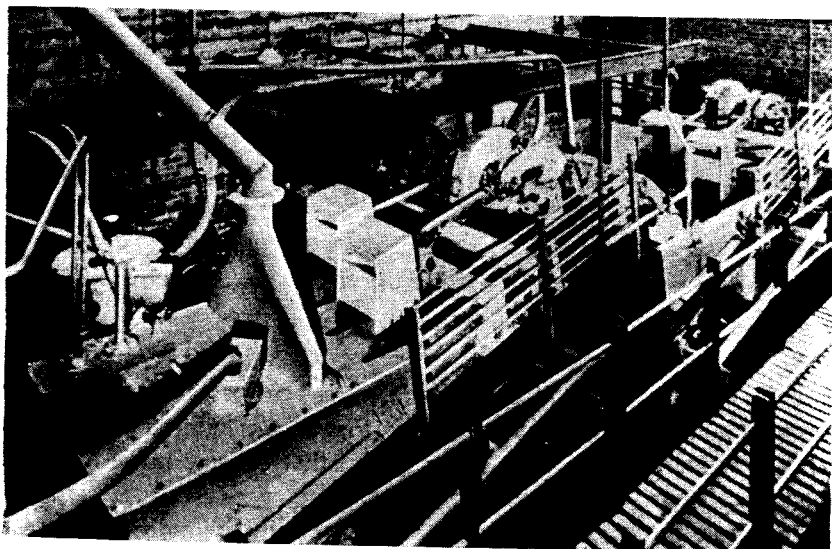

FIG. 23. Continuous vacuum filters (exterior view) [55].

During dilution nitric oxides are evolved abundantly (more than 7 kg/hr). These oxides are extracted by means of a ventilator or steam ejector to a cooling tower where they are brought to 20–30°C. The tower, which measures 1.8 m in diameter

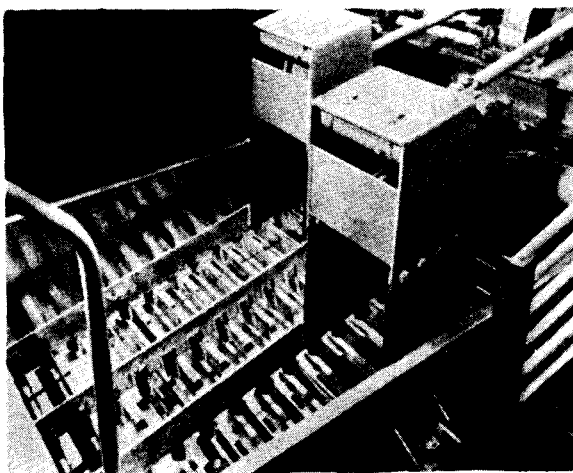

FIG. 24. An interior view of the filter [55].

and 3.3 m in height, contains steel pipes 38 mm in diameter, cooled externally with water. Here some of the vapour is condensed and nitric oxides pass on to the absorption towers (Fig. 22).

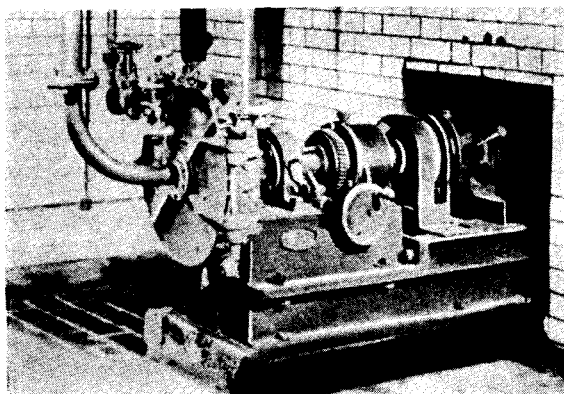

FIG. 25. Disk mill for cyclonite slurry [55].

Filtration. The suspension of cyclonite in nitric acid passes through a pipe 7.5 cm in diameter to a continuous vacuum filter (Fig. 23, 24) encased in stainless steel. The casing is connected with the suction system that conveys nitric oxides to the absorption towers.

The product, after filtration, is conveyed mechanically to another filter on which the cyclonite is washed with cold water until deacidification is as complete as pos-

sible. Mechanical scrapers remove wet, washed cyclonite from the filter and it is transferred in trucks to be purified.

Spent acid and that from the absorption towers is distilled over sulphuric acid.

Purification. Crude cyclonite consists of crystals of various sizes. They still contain 0.1–0.2% of nitric acid. For purification a suspension of cyclonite in water

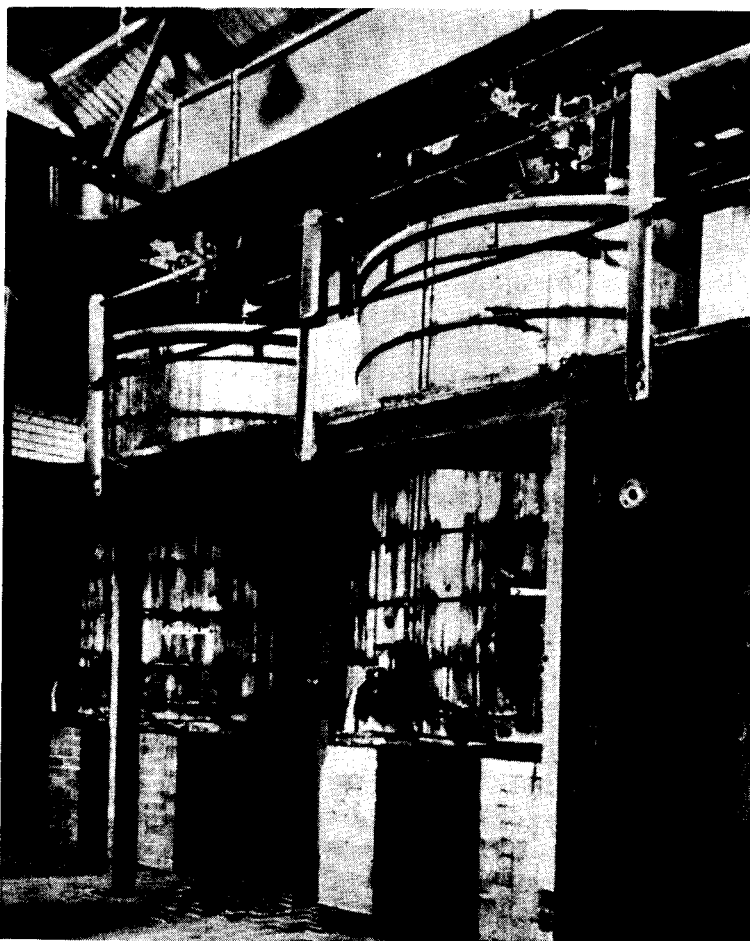

FIG. 26. Cyclonite boiling vats [55].

is conveyed by suction via a stainless steel container to stainless steel disk mills (Fig. 25) where the cyclonite crystals are finely ground. From the mill the ground product suspended in water is pumped to wooden boiling vats (Fig. 26) 250 cm high and 240 cm dia. The vats have sloping bottoms and are equipped with a stirrer and a pipe supplying live steam. There are two valves in the sides: one, in the lowest part of the vat, can be used for emptying it, the other, 105 cm from the bottom, is used for decantating the liquid. Each load amounts to about 2500 kg of dry cyclonite.

The suspension of the ground cyclonite in water is allowed to stand in the vat for $\frac{3}{4}$ hr. The liquid is then decanted from above the cyclonite layer and allowed to run through a filter which retains any finely-divided product carried away by the water. After the liquid has been decanted the tub is filled with cold water, its contents are stirred, allowed to stand again, and then decanted. This operation is repeated three times after which the cyclonite is washed with hot water at 90–100 °C for 12 hr. After washing the liquid is decanted and the wet cyclonite is removed from the tub to the filter. The filtered cyclonite containing 10% of water, goes on to the department where explosive mixtures are prepared.

Material balance. To produce 1000 kg of cyclonite, 833 kg of hexamine and 8779 kg of HNO₃ are required; 3482 kg of dilute 55% HNO₃ are recovered plus 3429 kg of HNO₃ from the absorption towers. Thus the net consumption of HNO₃ for nitration is 1868 kg. In addition, 490 kg of H₂SO₄ are used for the concentration of HNO₃.

German method

This has been called the "SH-method" and the cyclonite so obtained "SH-Salz" after Schnurr [38] who developed the process in 1937–38.

Hexamine is added to 99% nitric acid in the proportion of 1 part of hexamine to 8 parts of acid, in a nitrator with a capacity of 1.5 m³ working on the batch system. The temperature is maintained between 5 and 10°C in the nitrator by means of a coil chilled with saline solution. Nitration takes 1 hr.

The contents of a number of nitrators then flow continuously through a series of reactors in which the reaction mixture remains for 2 hr, during which the nitration reaction is completed. In these reactors the temperature is kept at 15–20°C.

When reaction is complete the whole is introduced into a battery of six diluters with water maintained at a temperature of 70–75°C. The first diluter has a capacity of 3 m³, the following four 1.5 m³ each, and the last 3 m³. Sometimes, to initiate decomposition of the unstable nitration products, the presence of a small amount of nitrogen dioxide is required. The amount of water added to the diluter should be such that it maintains a 50% concentration of HNO₃. At this concentration cyclonite is fully precipitated. The suspension of cyclonite in acid then flows to a battery of coolers in which it is cooled gradually to temperatures of 50, 35, and 20°C.

Cyclonite is separated from acid on a vacuum filter and then washed with water.

Originally, the product was purified by boiling with water in an autoclave under a pressure of 3.5 atm, at 140°C for 2 hr. Since this entailed the risk of explosion, it was superseded by crystallization from acetone.

Nitric oxides evolved in the diluter are passed through a cyclone separator which retains liquid droplets, and thence to absorption towers in which the 50% spent acid is concentrated to yield 60% nitric acid.

To produce 1000 kg of cyclonite ("SH-Salz") by this process, 830–840 kg of hexamine and 7100 kg of 99% nitric acid are required, and 5200 kg of HNO₃ are

recovered and condensed to its initial concentration. The net consumption of acid is thus 1700 kg.

According to other data the raw material consumption per 1000 kg cyclonite is as follows:

	880 kg of hexamine
	6800–7760 kg of 99% nitric acid
from which	1720–1850 kg is used in the reaction and
	5080–5850 kg, which is recovered as 99% HNO ₃ .

The German specification for cyclonite ("SH-Salz") is:

melting point	above 200°C
ignition temperature	215–230°C
apparent density	700 g/l.
loss of weight when dried	
at 100°C for 5 hr should	
not exceed	.01%
Abel heat test at 120°C	10 min without visible change
(in a paraffin bath)	in the test paper (after 20 min
	a slight coloration is admis-
	sible)

An aqueous extract (obtained by boiling cyclonite with water) should have a neutral reaction and contain no Cl[⊖], SO₄^{2⊖} or NO₃[⊖] ions. Only traces of ammonia and formaldehyde are admissible (the latter is determined by a fuchsin solution decolorized with SO₂).

The product should not contain more than 0.1% of material insoluble in acetone. The acetone solution should not contain more than 0.2% of acid, calculated as HNO₃. An acetone solution precipitated with water should not contain SO₄^{2⊖} ions.

Cyclonite intended for high explosive charges should pass through a 0.75 mm mesh sieve. Cyclonite for caps and detonators should pass through a 0.60 mm. mesh sieve.

If necessary, cyclonite may be mixed with montan wax.

Cyclonite lots comprised 2500–7500 kg: 12.5 kg in paper bags were packed in cardboard boxes, with lids sealed by means of adhesive tape.

2. PREPARATION OF CYCLONITE FROM HEXAMINE, NITRIC ACID AND AMMONIUM NITRATE

This method was worked out by Knöffler [38], and is known as the "K-method".

It is based on the fact that hexamethylenetetramine contains 6 methylene groups per 4 amino groups, i.e. the number of amino groups is lower than that required for obtaining two molecules of cyclonite. In order to supply the additional two amino groups the appropriate amount of ammonium nitrate is added to the nitrating nitric acid in accordance with the equation:

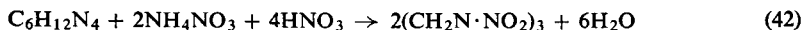

An increase in yield over that calculated on the basis of the hexamine used is thus obtained. The reaction proceeds only at a high temperature (about 80°C). This has gained favour because the reaction mixture of nitric acid, hexamine and ammonium nitrate may be heated to the desired reaction temperature without fear of an explosion, whereas a reaction mixture without ammonium nitrate may be dangerous even at a temperature just above 25°C.

According to the investigations of T. Urbański and Szyk-Lewańska [56], cyclonite is also formed by the action of nitric acid and ammonium nitrate on hexamethylene-triperoxidodiamine which is discussed on p. 225.

It is assumed that cyclonite is formed from this substance since it contains the grouping $-\text{CH}_2-\text{N}$. Six methylene groups are attached to two nitrogen atoms. The deficiency in nitrogen atoms is made good by ammonium nitrate, as described above.

According to a description from a factory at Elsnig nitration is conducted in reactors with a capacity of 500 l., in which 1 part of hexamine per 8.6 parts of nitric acid plus the calculated amount of ammonium nitrate are added to 99% nitric acid.

A temperature of 15°C is maintained in the nitrator by cooling and the reaction mixture enters the reactor below, which is equipped with a number of vertical pipes warmed externally with hot water. Here the reaction mixture is heated to 80°C and this temperature is maintained for 30 min while the reaction (42) involving ammonium nitrate takes place. The mixture is then introduced into the container below where the whole is cooled to 20°C.

Cyclonite in approximately 90% yield is crystallized in the following way: the product is separated from the spent acid on a rotary filter and after being washed with water and neutralized with a 5% solution of sodium carbonate it is crystallized from acetone.

In the method outlined above it is particularly difficult to utilize the spent acid due to the considerable amount of ammonium nitrate it contains. The usual method in which the nitric acid is recovered by distillation with sulphuric acid and condensation is not practicable since ammonium salts are deposited in the retorts, distillation columns, pipes, valves etc.

The following method has therefore been developed: after the cyclonite has been filtered off, the spent acid is cooled to -12°C . Ammonium trinitrate is then crystallized, separated in a centrifuge and recycled to the nitrator. After centrifuging the acid contains 10% of cyclonite and a considerable amount of ammonium nitrate. It is further processed so as to yield cyclonite, nitric acid being converted into ammonium nitrate.

The acid is allowed to run into a container of 3 m³ capacity where it is neutralized with gaseous ammonia while the temperature is raised to 70°C. The cyclonite thus formed is separated on a vacuum filter, and the filtrate is cooled when about two-thirds of the ammonium nitrate crystallizes. The latter is separated in a centrifuge, and used in the preparation of explosive mixtures. The small amounts of hexamine

dinitrate and ammonium nitrate that remain in the liquor are recovered, as a mixture, by concentrating the solution, after which they are returned to the nitrator.

To produce 1000 kg of cyclonite

480-500 kg of hexamine
 4800 kg of ammonium nitrate
 8600 kg of nitric acid

are required from which:

3600 kg of ammonium nitrate
 7200 kg of nitric acid

are recovered.

The consumption of ammonium nitrate amounts to 1200 kg and of nitric acid to 1400 kg.

3. PREPARATION OF CYCLONITE FROM SULPHAMIC ACID, FORMALDEHYDE AND NITRIC ACID

A method for the preparation of cyclonite from sulphamic acid, formaldehyde and nitric acid was developed in 1934 by Wolfram [38]. It is known as the "W-method" and the cyclonite so obtained is known as "W-Salz". The W-method is based on the condensation of the potassium salt of sulphamic acid with formaldehyde and the nitration of the condensation product ("white salt", a Schiff's base of the type XVIII) with nitric acid.

Starting from sulphuric anhydride and ammonia the following series of reactions was employed:

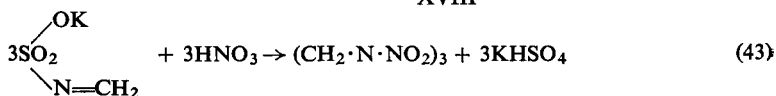
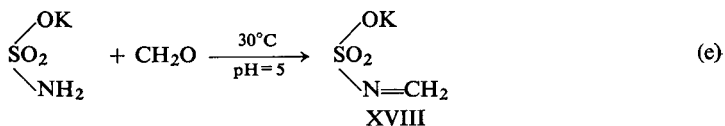
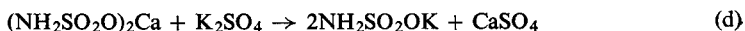
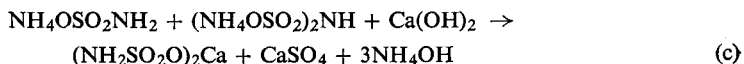
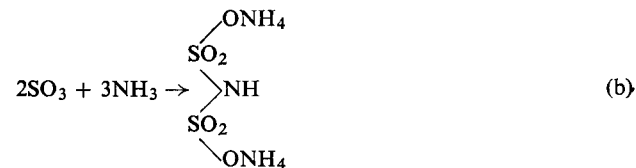
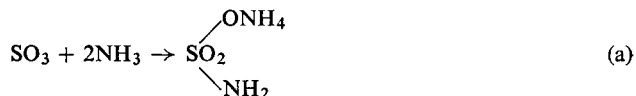

The ammonia evolved in reaction (c) during the preparation of calcium sulphamate is recycled to take part in reactions (a) and (b). Since calcium sulphamate dissolves fairly easily, it is transformed into the sparingly soluble potassium salt by reaction (d).

The mechanism of these reactions has been examined by Binnie, Cohen and Wright [57]. X-Ray investigations of the crystal lattice of this compound and cryometric studies, have shown that the compound XVIII has the structure of a cyclic trimer, i.e. that of 1,3,5-triazacyclohexanetrissulphonic acid (XVIIIa).

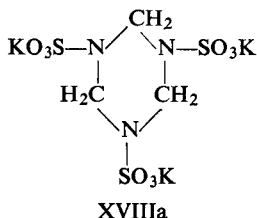

On treatment with nitric acid under completely anhydrous conditions (80% nitric acid and 20% SO_3) the compound (XVIIIa) gives cyclonite by substitution of the sulpho groups with nitro groups (80% of the theoretical yield). The reaction is interesting because the cyclonite is not decomposed in spite of the presence of sulphuric acid in the nitrating mixture. The reason is that the medium is completely anhydrous due to the presence of an excess of SO_3 .

For the nitration of compound (XVIII) the following nitrating mixture was used at Krümmel [38]:

HNO_3	80-81%
H_2SO_4	4-5%
SO_3	13-14%
N_2O_4	1-2%

This mixture was prepared from 99% nitric acid and sulphuric anhydride. "White salt" (XVIII) was introduced to the mixture at a temperature of 30°C. The heat evolved during nitration (approximately 500 kcal per kg of cyclonite) was removed by means of a cooling coil. The cyclonite so formed was partly suspended and partly dissolved in the nitrating liquid. Addition of water completely precipitated the product which was separated on a vacuum filter. The composition of the spent acid was:

HNO_3	23%
H_2SO_4	13-14%
KHSO_4	10-11%
H_2O	52-54%

The cyclonite was then washed with water and after neutralizing the residual acid with a 5% solution of sodium carbonate it was recrystallized. Initially, cyclonite was crystallized from nitrobenzene. However this proved to be dangerous due to the high boiling point of the solvent; after a plant had been destroyed by an explosion, crystallization from acetone was adopted. The spent acid is denitrated, and KHSO_4

recovered from the retort. The yield obtained ranked from 80 to 90%, depending on the formaldehyde used.

This method proved less profitable than others, and was discontinued by the end of World War II.

4. PREPARATION OF CYCLONITE FROM PARA-FORMALDEHYDE, AMMONIUM NITRATE AND ACETIC ANHYDRIDE

This method was worked out by Ebele [38], and known as the "E-method" in Germany. The same method was also invented independently by Ross and Schiessler [58] in Canada in 1940. In this process paraformaldehyde and ammonium nitrate undergo dehydration under the influence of acetic anhydride with the formation of cyclonite according to the equation:

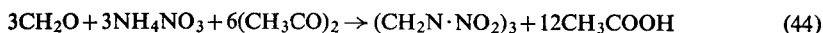

The studies of Wright *et al.* [59], and Winkler *et al.* [60] led to the conclusion that this method involves two essential steps.

The first is the synthesis of hexamethylenetetramine in acetic anhydride from paraformaldehyde and ammonium nitrate:

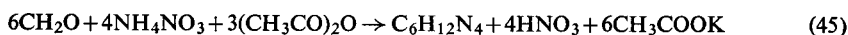

The second step is the known nitrolysis:

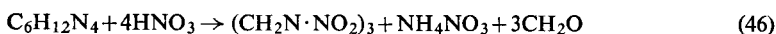

The detailed mechanism of this reaction will be dealt with later on p. 113.

The advantage of this method lies in the fact that the preparation of cyclonite is accomplished without using hexamine and nitric acid so that the dangers of nitration are avoided. On the other hand acetic anhydride is required, which is rather expensive.

This method is safe on condition that it is conducted as described below, by adding the reactants to the previously warmed acetic anhydride. Otherwise, the exothermic nature of the reaction may cause an explosion. It is therefore inadmissible to mix the reactants and heat up the mixture, since this causes too violent a reaction. Addition of boron fluoride to the mixture promotes the initiation of reaction and increase its safety.

It appears that apart from cyclonite, octogen (XI), a N-acetyl derivative (XXX) and a number of nitramines, mainly chain compounds, less stable than cyclonite, are also formed by this method, in side-reactions. Hence the cyclonite obtained has a relatively low melting point (190–195°C) and may be less stable than that prepared by other methods. The conduct of the reaction in the presence of boron fluoride reduces the number of by-products formed.

Since the majority of the chain compounds formed as by-products are more soluble in acetic acid than cyclonite itself, contamination of the latter with these substances may be partly avoided by filtering off the cyclonite from the spent acid. The

by-products can be recycled since some of them may be transformed into cyclonite on treatment with acetic anhydride and ammonium nitrate under the conditions in which the main reaction is conducted.

The by-products obtained during the reaction are discussed more fully on p. 113.

Manufacture at Bobingen [38,61] was on the following lines. A reactor of aluminium or stainless steel (capacity 1.2 m³) is filled with acetic anhydride and then 0.4% of BF₃ is added. Acetic anhydride is warmed to 60–65°C and at this temperature ammonium nitrate and paraformaldehyde are added gradually. Due to the high temperature and the presence of boron fluoride the reaction starts at once and heat is evolved. The heating is then turned off and the temperature maintained by cooling, within the range 60–65°C. The addition of the reactants requires approximately 6 hr, after which the contents of the reactor are cooled to 20°C. The precipitated cyclonite is separated from the solution on a vacuum filter. The by-products remain in the spent liquor.

160 kg of cyclonite are obtained from each reactor. The output from a number of reactors, amounting to about 800 kg, is stabilized by boiling in an autoclave at 140°C.

The spent acid is distilled in order to separate acetic acid. The paste containing cyclonite and by-products that accumulate on the bottom of the retort is removed continuously, through a syphon overflow. The greater part of this mass (about 80%) is dissolved in acetic anhydride and returned to the reactor while the residue (about 20%) is mixed with ammonium nitrate to make cheap explosives.

Acetic anhydride is prepared from distilled acetic acid by the ketene method with ethyl phosphate as a catalyst. The water from the first cyclonite wash on the vacuum filter contains on an average 20% of acetic acid which is recovered by extraction with ethyl acetate.

The yield of cyclonite on a plant scale is 63–65% calculated as formaldehyde; on a laboratory scale a yield of up to 80% may be obtained.

To produce 1000 kg of cyclonite requires

630–635 kg of paraformaldehyde
1800 kg of ammonium nitrate
and 5000–5100 kg of acetic anhydride containing about 19 kg of boron fluoride.

From the spent acid

about 110 kg of the paste of cyclonite and by-products
and 4150–4200 kg of acetic anhydride

are recovered.

Thus the consumption of acetic anhydride per 1000 kg of cyclonite amounts to *ca.* 800 kg.

According to the German data the product obtained contains:

93.5% of cyclonite
6.0% of octogen
0.5% of the acetyl derivative (XXIX)

5. PREPARATION OF CYCLONITE FROM HEXAMINE DINITRATE, AMMONIUM DINITRATE AND ACETIC ANHYDRIDE

This method is a combination of the first and fourth methods. It was worked out by W. E. Bachmann in the U.S.A. in 1941 and independently by Köffler [38, 62] in Germany in 1943. In Germany it was known as the "KA-method".

Hexamine dinitrate is reacted with ammonium dinitrate in the presence of acetic anhydride. Unlike the E-method no paraformaldehyde is used, all the necessary methylene groups being provided by hexamine, and the additional amino groups (as in the K-method) by ammonium nitrate. Nitric acid enters into reaction in combination with hexamine and as ammonium dinitrate:

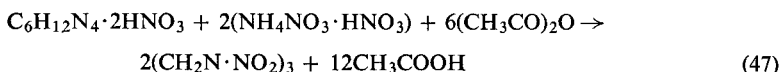

The yield by this method, calculated on the CH_2 groups in hexamine dinitrate, amounts to 75–80%.

The advantage of the KA-method, as compared with the E-method, lies in the fact that the methylene and part of the amino groups required are introduced in a dehydrated form, hexamine being their source, whereas when paraformaldehyde is used, dehydration is essential. Hence less acetic anhydride is used in the KA-method than in the E-method.

At the Bobingen factory hexamine dinitrate is prepared by the action of 50% nitric acid on hexamine at a temperature below 15°C, using spent acid from the nitration of pentaerythritol. $\text{NH}_4\text{NO}_3 \cdot \text{HNO}_3$ is obtained by the reaction of equimolecular amounts of ammonium nitrate and concentrated nitric acid.

325 kg of acetic anhydride is mixed in the reactor with 187 l. of filtrate from the previous batch. While maintaining the temperature between 40 and 50°C five portions of 23.9 kg of ammonium dinitrate and of 22 kg of hexamine dinitrate are added to the reactor, after which 271 kg of acetic anhydride are introduced followed by a further 5 portions of ammonium dinitrate and hexamine dinitrate, as above. Experience showed that a small excess of hexamine dinitrate is useful. After the last portions of the reactants have been added, the contents of the reactor are heated to 60°C and this temperature is maintained for 0.5 hr. This procedure requires 4 hr, after which the whole is cooled to 20°C. Cyclonite, crystallized in 70–71% yield, is filtered off. The melting point of the product ranges between 188 and 190°C.

Part of the filtrate is recycled, while most of it undergoes distillation. On distillation, a paste-like residue of highly impure cyclonite (m.p. 160°C — total melting) is obtained. Under the reaction conditions this product may be transformed into cyclonite, after it is returned to the reactor.

The filtered cyclonite is washed with water, to yield a 30% solution of acetic acid from which concentrated acetic acid is recovered by extraction with ethyl acetate.

The consumption of ethyl acetate amounts to 1 kg per 100 kg of cyclonite. From the recovered concentrated acetic acid 85% acetic anhydride is produced by the ketene method.

To produce 1000 kg of cyclonite the KA-method requires

- 400 kg of hexamine
- 430 kg of ammonium nitrate
- 680 kg of 99% nitric acid
- 2400 kg of acetic acid (as anhydride)

from which about 1950 kg of acetic acid are recovered, i.e. the net consumption amounts to about 450 kg.

During World War II W. E. Bachmann *et al.* [62, 63, 64] worked out a process of cyclonite manufacture identical in principle to the above. Bachmann's idea was to combine Ross's E-method with hexamine nitration. A semi-plant scale equipment based upon the new "combined" Bachmann process came into operation at the end of 1941. After the procedure for cyclonite production had been worked out, the problem of the regeneration of acetic acid was solved; in the United States cyclonite was produced mainly by this method.

The procedure worked out by Bachmann differs from that described above in that the solution of 117 parts of 98% nitric acid in 508 parts of acetic anhydride is first prepared while maintaining the temperature between 5 and 15°C.

The solution is then heated to 70–75°C and a mixture of 114 parts of ammonium nitrate with 192 parts of hexamine dinitrate is introduced gradually in portions (hexamine dinitrate is prepared beforehand by treating 65 parts of 70% nitric acid with a solution of 40 parts of hexamine in 70 parts of water, at 15°C; the mixture is then cooled to 5°C and the dinitrate is filtered off in 95% yield).

When the mixture of ammonium nitrate with hexamine nitrate is introduced to a solution of nitric acid in acetic anhydride heat is evolved and the temperature rises spontaneously. At that point heating should be stopped and the temperature maintained within the limits of 73–78°C, by cooling. After the reactants have been introduced the whole is stirred for 15 min longer, maintaining the temperature at 75°C by heating. The whole is then cooled to 60°C, and the product is filtered, washed with acetic acid, and then with water. The melting point of the product thus obtained is 203–204°C. 195–202 parts of cyclonite are obtained (61–63% of the theoretical yield). The yield increases to 70–73.5% if the mixture is cooled after the reaction to 25°C, but the product then contains a lot of octogen, hence its melting point is 191–202°C.

The heat of reaction was determined by Gilpin and Winkler [51]. The reaction of a solution of hexamine with Bachmann's reagent to yield cyclonite is exothermic: $-\Delta H = 140$ kcal/mole.

Hexamine mononitrate gives a heat effect of $-\Delta H = 126$ kcal/mole with Bachmann's reagent while hexamine dinitrate with the same reagent gives $-\Delta H = 118$ kcal/mole.

At the Elsnig factory the crystallization of cyclonite is accomplished as follows. About 110 kg of cyclonite are introduced into a closed tank, with a capacity of 1000 l., equipped with stirrers and lined with a woollen filter cloth. Approximately 900 l. of acetone heated to 50°C are run into the tank to dissolve the cyclonite, after which the solution filtering through the filter cloth is drained down into a 3000 l. tank. (The filter cloth is changed every 10 hr). Here about 1350 l. of water is added over a period of 5 min, while the temperature is maintained at 25°C, and cyclonite is precipitated from the acetone solution in the form of fairly large crystals: approximately 90% of the total are longer than 0.1 mm. The precipitated cyclonite is separated on a vacuum filter.

Acetone vapour is recovered in an absorber. The aqueous acetone filtered from the cyclonite is purified and freed from water by distillation in a rectifying column. The acetone losses amount to 7–8% per 100 kg of cyclonite.

According to data from German factories, desensitization ("phlegmatization") of cyclonite is carried out as follows. A phlegmatizing tank, equipped with a heating or cooling jacket, is filled with 450–500 l. of hot water (80–88°C). The stirrer (170 r.p.m.) is then started and 120 kg of recrystallized cyclonite is poured in. Molten montan wax is then introduced in the proportion of 5–10% the weight of cyclonite.

If a smaller amount of wax is used, a higher temperature should be maintained, viz. addition of 5% wax requires about 88°C and 10% between 80 and 82°C.

After the wax has been added and incorporated, the cooling should start immediately by introducing cold water into the jacket. The overall procedure requires approximately 2 hr. The phlegmatized cyclonite is filtered on a vacuum filter, dried at 100°C and sieved.

To differentiate phlegmatized cyclonite from the non-phlegmatized product a dye is added during mixing.

THE THEORY OF CYCLONITE FORMATION BY METHODS 4 AND 5

Examination of the mechanism of cyclonite formation has clarified the conditions under which various products similar in structure to cyclonite are formed. These products always accompany cyclonite prepared by method 5 and often that prepared by method 4.

In method 5, as in method 1, nitrolysis of hexamethylenetetramine occurs, the alcohol groups so produced being esterified with acetic anhydride and not with nitric anhydride as in method 1. The most important by-product formed to the extent of nearly 10% by method 5 is octogen (XI). It is produced as outlined above, as a result of hexamine nitrolysis (p. 90).

In the presence of acetic anhydride hexamethylenetetramine dinitrate may be transformed into the product (XIX), and then into (XX). These are the analogues of substances (V) and (VI).

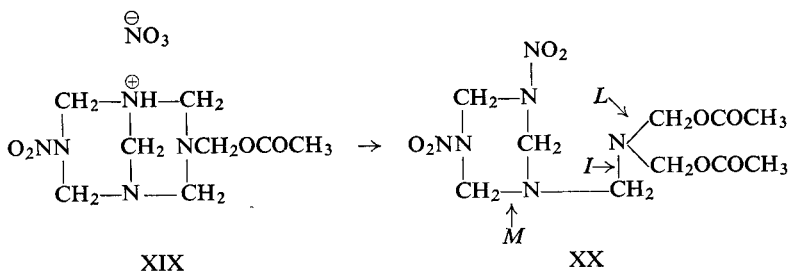

The nitrolysis of the bond *I* in substance (XX) results in the formation of products (XXI) 1-acetoxymethyl-3,5-dinitro-1,3,5-triazacyclohexane and (XXII) bis(acetoxymethyl)-nitramine

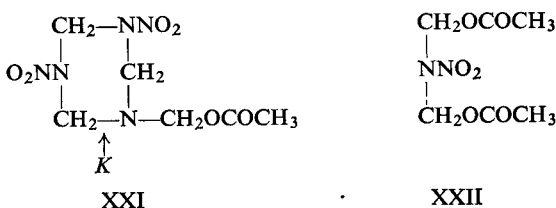

Substance (XXI) may subsequently undergo nitrolysis at *K* to form the nitramine ester 1,7-diacetoxy-2,4,6-trinitro-2,4,6-triazazepane (XXIII) (a chain compound "BSX", m.p. 154–155°C):

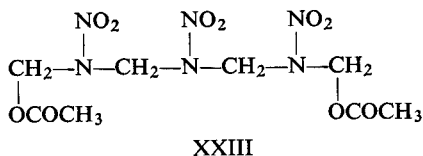

This compound sometimes occurs in an appreciable quantity in cyclonite prepared by methods 4 and 5. It is an undesirable by-product due to its high sensitivity to impact and to its relatively poor stability, which is lower than that of cyclonite. Bachmann and Sheehan [62] found that stirring the reactants at a low temperature (e.g. 0°C) and subsequently heating the whole to 75°C favours the formation of the product (XXIII).

On the other hand, Wright *et al.* [47] found that the nitrolysis of hexamine with nitric acid in the presence of acetic anhydride but in the absence of ammonium nitrate involves a decrease of the yield of cyclic products. The amount of the chain compound (XXIII) formed is then increased.

The fact that nitramino groups may arise under the influence of ammonium nitrate and nitric acid in the presence of acetic anhydride is shown by the reaction in which aminomethylnitramines (obtained from nitramine, formaldehyde and, say, morpholine) are treated with acetic anhydride in the presence of ammonium nitrate and nitric acid at 55°C (Lamberton *et al.* [65]):

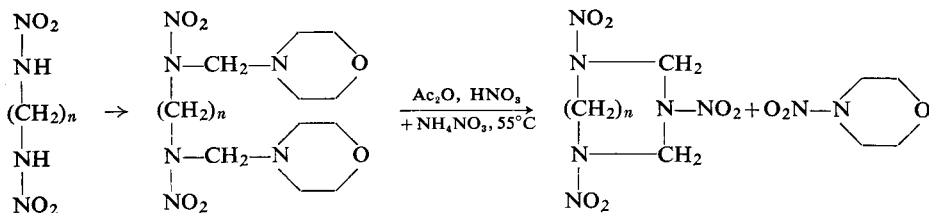

Compound (XXIII) may undergo nitrolysis resulting in the formation of the ester (XXIV) — 1,5-diacetoxy-2,4-dinitro-2,4-diazapentane:

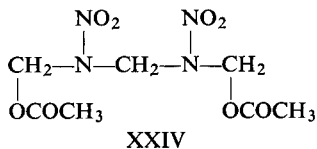

The chain compound XXV, 1,9-diacetoxy-2,4,6,8-tetranitro-2,4,6,8-tetrazonane m.p. 182.5–183.5°C may also arise from compound (XX) by nitrolysis of the bonds *L* and *M*.

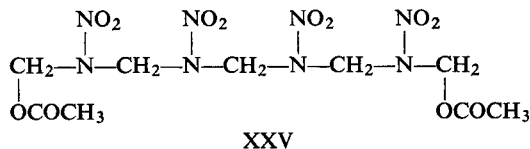

It is possible that there may not be time for the free alcohols (XXVI) and (XXVII) to be transformed into esters (XIX) and (XX), but under the influence of ammonium nitrate they will undergo “demethylation” with loss of formaldehyde molecules.

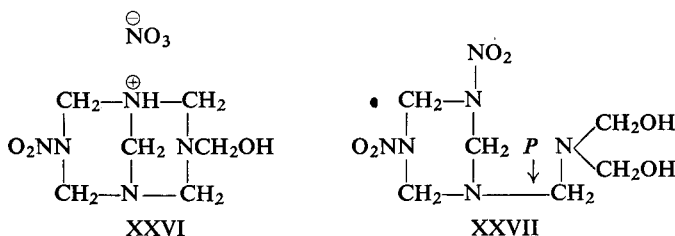

If compound (XXVI) is “demethylated”, the compound (XII) (DPT) will be produced as a result of the additional nitration.

In method 5 ammonium nitrate not only supplies the necessary number of nitramino groups, but also brings about the loss of molecules of formaldehyde from the intermediate products of types (XXV) and (XXVII). If the time is too short for the esterification of the alcohol (XXIII), nitrolysis of this compound occurs first at the bond *P* (not at bonds *L*, *M* and *I* as in the acetylated product (XX)) and cyclonite is formed.

Experiments have shown that the chain compounds of types (XXIII), (XXIV) and (XXV) or the compound (IX) described earlier may also undergo cyclization

under the influence of nitric acid, acetic anhydride and ammonium nitrate (Chapman [66]).

On synthesis of cyclonite from paraformaldehyde, ammonium nitrate and acetic acid (method 4), products with cyclic structure, chiefly cyclonite and octogen, may arise due to the polymerization of the transiently-formed, hypothetical methylenenitramine (XXVIII) [67]:

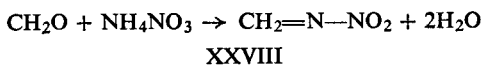

There is an alternative view (e.g. expressed by Wright *et al.* [59]) that hexamethylenetetramine is first formed and then nitrolysed. This assumption is said to be supported by the separation from the reaction products of both methods 4 and 5 of the cyclic products (XXIX) 1-aceto-3,5-dinitro-1,3,5-triazacyclohexane and (XXX) 1-aceto-3,5,7-trinitro-1,3,5,7-tetrazacyclo-octane which may also be obtained from hexamine by treating it with nitric acid and acetic anhydride:

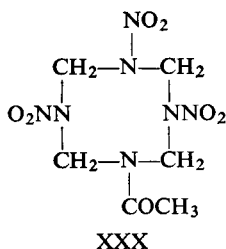
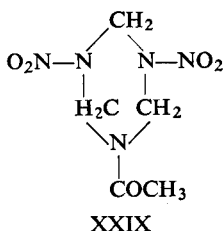

The reaction products (in methods 4 and 5) also include other cyclic N-acetyl derivatives: (XXXI) 1,5-diaceto-3,7-endomethylene-1,3,5,7-tetrazacyclo-octane and (XXXII) 1,5-diaceto-3,7-dinitro-1,3,5,7-tetrazacyclo-octane:

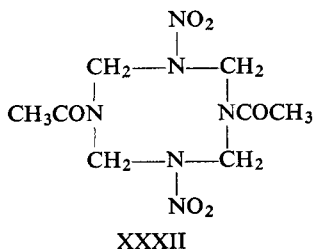
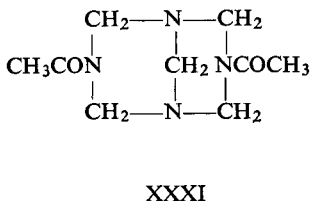

Under the influence of acetic anhydride and nitric acid compound (XXX) gives (XXV) (Marcus and Winkler [68]).

The transient formation of hexamine in method 4 was confirmed by Winkler, Gillies and Williams [60] (see equation (45)) who examined the reaction mechanism of cyclonite preparation by method 4. They found that hexamine dinitrate is formed at 35°C as an intermediate product. At the same time nitric acid is evolved hence nitrolysis of hexamine dinitrate may occur, in other words the mechanism of cyclonite formation would be similar to that of direct nitration of hexamine with nitric acid.

This observation also appears to explain why an excess of paraformaldehyde should have a harmful influence on the yield of cyclonite. In particular, Winkler noticed that the addition of formaldehyde to a hexamine solution in aqueous acetic acid causes the decomposition of hexamine which proceeds at a rate depending on the ratio of formaldehyde to hexamine.

The formation of octogen in method 5 will be discussed below.

OCTOGEN

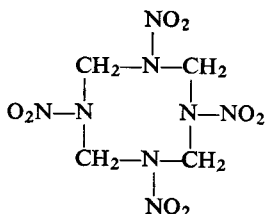

XI, m.p. 276-277°C

Octogen, known in Britain as HMX, i.e. cyclotetramethylenetetramine, 1,3,5,7-tetranitro-1,3,5,7-tetrazacyclo-octane, is a white crystalline substance which occurs under several polymorphous forms differing from one another in specific gravity and sensitiveness to impact. Usually octogen is obtained in β form, which is the least sensitive to impact (Table 21).

McCrone [69] found that octogen is polymorphic and exists in four forms I (β), II (α), III (γ) and IV (δ). The first three are stable at room temperature, but HMX-IV transforms very readily.

HMX-I can be prepared in different ways. Wright *et al.* [70] recommend preparation by cooling a hot saturated solution of octogen in acetone or acetonitrile. HMX-II was prepared [70] by dissolving HMX in hot 70% nitric acid: crystals of HMX-II precipitate on cooling. When HMX-I was dissolved by warming in 50% acetic acid, HMX-III precipitated on cooling. HMX-III can also be obtained by steam distilling off the solvent from a hot solution of HMX in water-saturated cyclohexanone. When HMX-I was sublimed at 180°C, the product was HMX-IV.

All the crystalline forms were examined by Wright *et al.* [70]. They examined X-ray diffraction pattern, infra-red spectra and dielectric constants. They concluded that the HMX polymorphs are actually lattice-caged conformational modifications.

Octogen, like cyclonite is insoluble in water and non-hygroscopic. Its solubility in organic liquids is similar to that of cyclonite. Octogen and cyclonite are almost alike in chemical reactivity. They differ only in that octogen is more resistant to the action of sodium hydroxide than cyclonite. This reaction forms the basis of one of the methods of separating octogen from cyclonite. It consists in heating the mixture of octogen and cyclonite with a hydroxide solution under such conditions that the latter is decomposed while the former remains unaltered.

TABLE 21
 PROPERTIES OF OCTOGEN (ACCORDING TO RINKENBACH [71])

Properties	Form			
	α	β	γ	δ
Specific gravity	1.96	1.87	1.82	1.77
Relative sensitiveness to impact (cyclonite=180)	60	325	45	75
Stability of crystalline form	metastable	stable	metastable	labile

Another method of separating octogen from cyclonite depends on the difference in solubility of the two substances. Octogen is more easily soluble in 55% nitric acid or 2-nitropropane than cyclonite. The mixture is warmed in nitric acid and filtered and a mixture enriched in octogen is crystallized from the filtrate. Cyclonite, being soluble in 2-nitropropane, is then extracted from the mixture with solvent, while octogen remains undissolved. Octogen can be purified by crystallization from 70% nitric acid.

A mixture of cyclonite and octogen, rich in octogen, is best prepared by method 5, i.e. from hexamine nitrate, ammonium nitrate and acetic anhydride. A particularly large amount of octogen is formed when the product is prepared by Bachmann's method at temperatures ranging from 73 to 78°C and the mixture is then cooled to 25°C and filtered. This mixture m.p. 191–202°, contains approximately 10% of octogen.

The ratio of cyclonite to octogen produced by method 5 was examined by Epstein and Winkler [72]. They found that in general reduction in the amount of ammonium nitrate used for the reaction reduces the yield of cyclonite and increases that of octogen.

The results of these experiments are given in a graph (Fig. 27) which shows that the largest amount of octogen is formed when two moles of ammonium nitrate react with one of hexamine.

Bachmann *et al.* [64] also described the conditions under which the substance (XII) (DPT) can be prepared in a yield of about 20% from hexamine and nitric acid, in the presence of acetic anhydride and acetic acid, at temperatures between 15 and 30°C. On nitrolysis with nitric acid in the presence of ammonium nitrate and acetic anhydride at 60–65°C, this substance gives octogen in 80% yield.

As an explosive octogen is superior to cyclonite in that its ignition temperature is higher (an explosion ensues in 5 sec at 335°C while with cyclonite this occurs at 260°C). The chemical stability of octogen is also superior. In a vacuum, at 120°C in 40 hr octogen evolves 0.4 cm³ of gas (cyclonite 0.9 cm³) at 150°C it evolves 0.6 cm³ of gas (cyclonite 2.5 cm³). Thus, at 150°C octogen possesses a stability of the same order as trinitrotoluene or picric acid.

According to A. J. B. Robertson [23] decomposition of octogen at temperatures above 280°C occurs as a monomolecular reaction. Activation energy $E=52.7$ kcal, $\log B=19.7$.

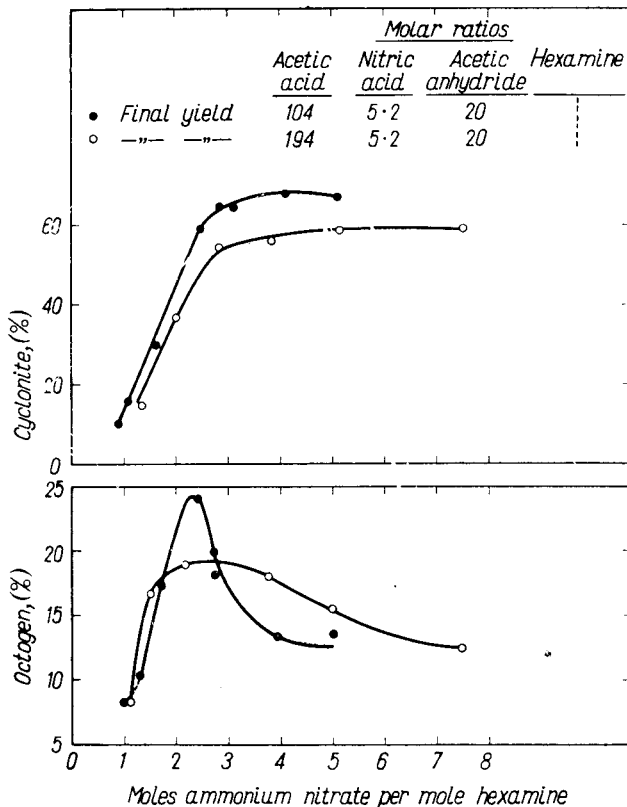
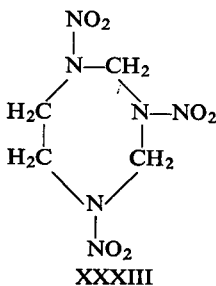

FIG. 27. Effect of ammonium nitrate on relative yields of cyclonite and octogen, according to Epstein and Winkler [72].

In explosive power octogen is somewhat less powerful than cyclonite, its lead block expansion being 450 cm³ whereas that of cyclonite is 500 cm³.

By virtue of these properties, the presence of octogen in cyclonite is not very harmful. Octogen, however, is not used independently as an explosive, being employed solely as a substance accompanying cyclonite.

HOMOCYCLONITE



Homocyclonite (Homohexogen) is an homologue of cyclonite with a 7-membered ring. Wright and Myers [43] prepared it by the nitrolysis of compound XXXIV (which arises as a result of the action of formaldehyde and ammonia on ethylene-dinitramine):

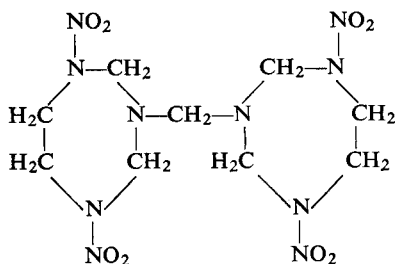

XXXIV
m.p. 205°C (decomp.)

NITRO DERIVATIVES OF MELAMINE

Melamine is now a very important chemical product since it is a starting substance for the manufacture of plastics. The presence in melamine of a triazine ring, as in cyclonite, and of three amino groups induced attempts to nitrate this substance in order to obtain an explosive nitramine.

Whitmore and Cason [73] examined the mechanism of the direct nitration of melamine with nitric acid in the presence of acetic anhydride at 5°C and obtained an explosive product (I). By nitrating a triacetyl derivative of melamine with nitric acid in the presence of acetic anhydride at 20–25°C Cason prepared product (II). This substance hydrolyses, losing N₂O, which results in the formation of a stable compound (III)

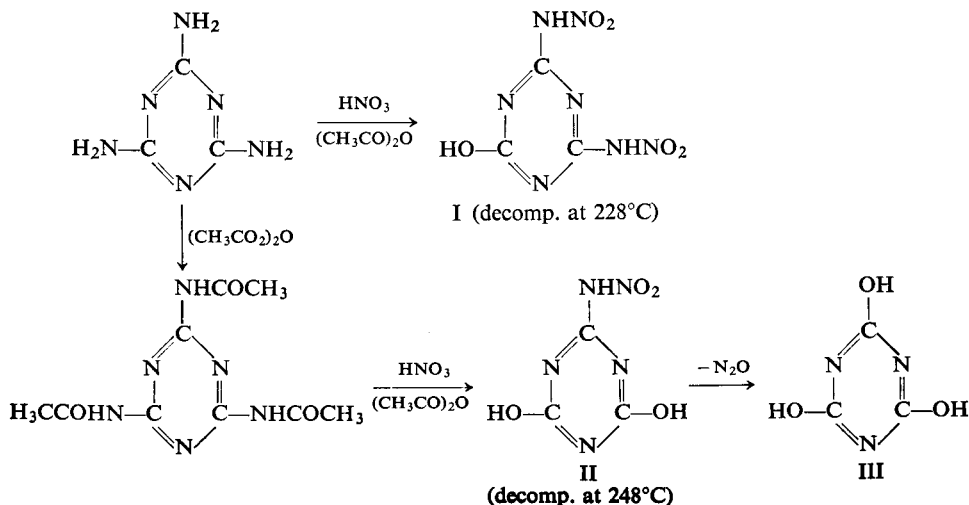

Atkinson and Whitmore [74] elucidated the structure of these compounds. They showed that compound (I) is *N,N'*-dinitroammeline, compound (II) nitroammelide and compound (III) cyanuric acid. The authors also showed that fuming nitric acid at 20–25°C transforms triacetylmelamine into *N*-nitro-*N',N''*-diacetyl melamine (IV)

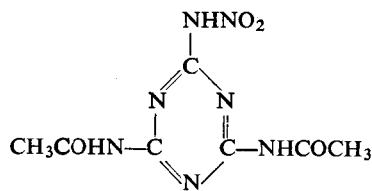

IV

(decomposition at 300°C)

All these substances decompose without melting. Only dinitroammeline (I) has explicit explosive properties.

NITROSAMINES

Trimethylenetrinitrosamine (TMTN) 1,3,5-trinitrosohexahydro-sym-triazine, 1,3,5-trinitroso-1,3,5-triazacyclohexane (I) and dinitrosopentamethylenetetramine (DNPT) or 1,5-endomethylene-3,7-dinitro-1,3,5,7-tetrazacyclo-octane or 3,5-dinitroso-1,3,5,7-tetrazabicyclo [3,3,1] nonane (II)

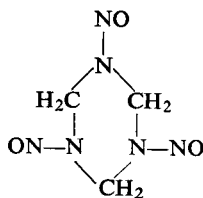

I
m.p. 105–107°C

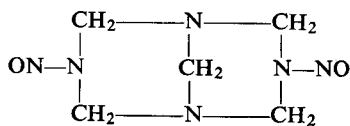

II
m.p. 206–207°C

Trimethylenetrinitrosamine (I) was first described in 1881 by F. Mayer [75] who suggested the structure (I). Duden and Scharff [76], Bachmann and Deno [77], and Aubertein [78] gave detailed descriptions of its preparation and chemical properties. Finally, Ficherouille and Kovache [79] worked out the mechanism of its production on a semi-commercial scale.

Dinitrosopentamethylenetetramine (II) was first obtained by Griess and Harrow [80]. Formulae of these two substances (I) and (II) were proposed by Cambier and Brochet [81] and Duden and Scharff [76].

They are formed by the action of nitric acid on hexamethylenetetramine at a low temperature (max +8°C). Depending on the pH of the solution, the compounds (I) or (II) are obtained, viz.: at pH=1–2, trimethylenetrinitrosamine (I) is formed whereas at pH=3–6, dinitrosopentamethylenetetramine (II) is formed.

The yield of both reactions is 65–70%. According to Aubertein [78] substance (I) may be prepared in a yield 84% of theoretical.

The explosive properties of this compound (I) may be of particular interest.

Trimethylenetrinitrosamine

Physical properties. The specific gravity of the substance is 1.508. It is sparingly soluble in water. Šimeček and Doležel [82] report the following figures for its solubility, expressed as the amount in grammes dissolved per 100 g of solvent (Table 22):

TABLE 22

	20°C	40°C	60°C
Water	0.2	0.3	0.6
Ethyl ether	0.8	1.2 at 34°	—
Toluene	1.4	2.3	4.4
Methyl alcohol	4.3	7.7	18.1
Acetone	68.5	139.7	254.5

According to Médard and Dutour [83] when molten the substance mixes with trinitrotoluene and gives an eutectic consisting of 58% of trinitrotoluene and 42% of trimethylenetrinitrosamine. The eutectic melts at about 55°C.

The thermochemical properties of this compound are of great interest. As early as 1896 Delépine [84] determined its heat of formation ($-\Delta H_f$) and found it to be negative. This observation was confirmed in later work by the same author and by Badoche [85] as well as in more recent experiments by Médard and Thomas [86]. According to the latter the heat of combustion of the compound (I) $-\Delta H_v = 557.17$ kcal/mole, hence its heat of formation is $-\Delta H_f = 71.1$ kcal/mole, i.e. 408 kcal/kg. The heat of detonation was found to be 850 kcal/kg.

Chemical properties. Trimethylenetrinitrosamine (I) decomposes explosively under the influence of concentrated sulphuric acid at room temperature. At a low temperature it is hydrolysed to form trimethylenetriamine sulphate (III)

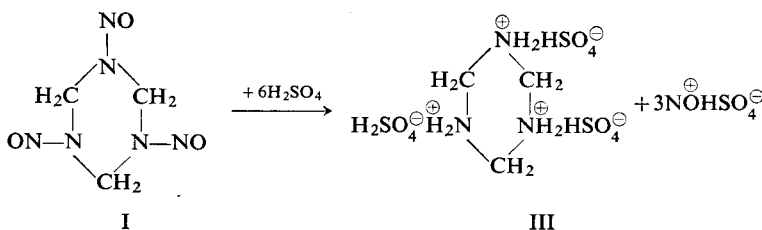

According to Šimeček [87] trimethylenetriamine undergoes further decomposition to a Schiff's base:

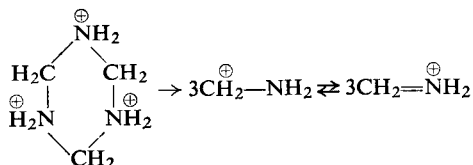

Sodium hydroxide causes slow decomposition in the cold and rapid in the hot, with evolution of formaldehyde, nitrogen and ammonia. Rapid decomposition also occurs in boiling water and slow decomposition occurs in water at room temperature.

Oxidation of (I) leads to cyclonite. According to the work of Brockmann, Downing and Wright [12] oxidation with a solution of hydrogen peroxide (30%) in nitric acid (99%) in the ratio of 1 mole (I) to 82 moles of nitric acid, 3 moles of H_2O_2 and 3.7 moles of H_2O , at -40°C , gives dinitro-nitrosamine (IV) as an intermediate:

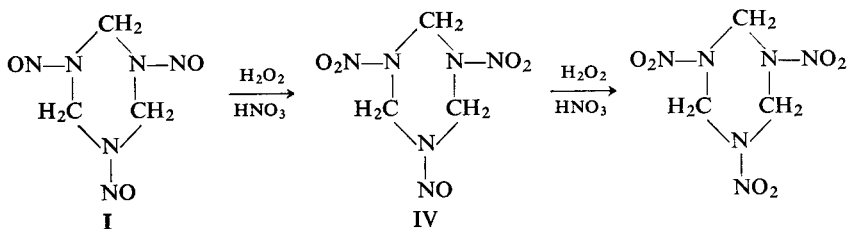

The yield of cyclonite in this reaction is 74%.

Explosive properties. The apparent density of trimethylenetrinitrosamine (I) is 0.84, according to Médard and Dutour [83]. The same authors give the following relationship between density and the compressing pressure:

pressure kg/cm ²	density
170	1.10
340	1.23
680	1.37
1020	1.44
1700	1.525
2380	1.57
3000	1.59

Complete detonation is obtained:

- at a density of 0.85 by 0.30 g of mercury fulminate
- at a density of 1.20 by 0.40 g of mercury fulminate
- at a density of 1.40 by 0.50 g of mercury fulminate
- at a density of 1.57 by 2.5 g of mercury fulminate

According to these authors sensitiveness to impact is of the same order as that of trinitrotoluene.

Šimeček and Šramek [88] give the following table for sensitiveness to impact in the drop test, using a 5 kg weight:

Weight falling from a height of cm	% of explosions
20	0
30	30
40	67
50	100

The value of the heat of detonation was reported earlier (p. 120).

According to Médard and Dutour the lead block expansion is 125.5 (taking picric acid as 100). The rate of detonation at a loading diameter of 30 mm is as follows:

Density	Rate m/sec
0.85	5180
1.00	5760
1.20	6600
1.40	7330
1.50	7600
1.57	7800

Charges of molten and solidified material at a density of 1.42 give a rate of detonation of between 7000 and 7300 m/sec.

In air the substance takes fire fairly easily and burns regularly.

The same authors examined the rate of detonation of a molten and solidified eutectic comprising 58% of trinitrotoluene and 42% of substance (I), and obtained a value of approximately 7000 m/sec.

Médard and Dutour [83] made a detailed investigation of the stability of the substance (I). At room temperature test samples of the substance remained apparently unaffected for 6 years. Marked decomposition occurred with rising temperature, beginning at about 150°C; at 160°C nitric oxides are evolved. Rapid heating causes immediate decomposition at 300°C and at 200°C decomposition occurs after 2 minutes.

The substance is exceptionally sensitive to the action of acids. When mixed with picric acid, for example, it undergoes violent decomposition after 2 hours' heating at 60°C. At 100°C decomposition ensues in 10–15 minutes. A mixture with trinitrotoluene is decomposed at 85°C.

The molten substance may react with such metals as iron, copper, aluminium. Thus, despite the fact that substance (I) is a powerful explosive, only slightly sensitive to impact, its low stability even in the presence of traces of substances with an acid reaction gives little promise for its practical use.

Dinitrosopentamethylenetetramine

Dinitrosopentamethylenetetramine (II) is used as a gasifiable product for the production of porous plastics and rubber (e.g. Unical ND, Vulkacel BN).

LITERATURE

1. F. LENZE, according to H. KAST, *Spreng- u. Zündstoffe*, Vieweg & Sohn, Braunschweig, 1921.
2. G. F. HENNING, Ger. Pat. 104280 (1899).
3. G. F. HENNING, Ger. Pat. 298412, 298539, 299028 (1916).
4. G. C. V. HERZ, Brit. Pat. 145793 (1921); U.S. Pat. 1402693 (1922).
5. G. C. HALE, *J. Am. Chem. Soc.* **47**, 2754 (1925).
6. P. TERPSTRA, *Z. Krist.* **64**, 150 (1924).
7. R. HULTGREN, *J. Chem. Phys.* **4**, 84 (1936).
8. G. EDWARDS, *Trans. Faraday Soc.* **49**, 152 (1953).
9. A. MAJRICH, *Mém. artill. franç.* **14**, 127 (1935).
10. T. URBAŃSKI and B. KWIATKOWSKI, *Roczniki Chem.* **13**, 585 (1933).
11. T. URBAŃSKI and I. RABEK-GAWROŃSKA, *Roczniki Chem.* **14**, 239 (1934).
12. F. J. BROCKMANN, D. C. DOWNING and G. F. WRIGHT, *Can. J. Research* **27 B**, 469 (1949).
13. M. DELÉPINE, *Bull. soc. chim. France* [4], **9**, 1025 (1911).
14. E. VERNAZZA, *Atti reale accad. sci. Torino* **70**, I, 404 (1934/35).
15. J. ŠIMEČEK, *Chem. Listy* **51**, 1323, 1699 (1957); *XVI Congrès International de la Chimie Pure et Appliquée II*, p. 310, Paris, 1957.
16. F. SOMLO, *Z. ges. Schiess- u. Sprengstoffw.* **35**, 175 (1940).
17. S. EPSTEIN and C. A. WINKLER, *Can. J. Chem.* **29**, 731 (1951).
18. W. H. JONES, *J. Am. Chem. Soc.* **76**, 829 (1954).
19. M. AVOGADRO, *Mém. artill. franç.* **10**, 875 (1931).
20. T. URBAŃSKI and J. PILLICH, *Wiad. Techn. Uzbr.* **43**, 79 (1939).
21. M. TONEGUTTI, *Chimica e industria* **17**, 517 (1935).
22. A. HAID, F. BECKER and P. DITTMAR, *Z. ges. Schiess- u. Sprengstoffw.* **30**, 66, 105 (1935).
23. A. J. B. ROBERTSON, *Trans. Faraday Soc.* **45**, 85 (1949).
24. T. URBAŃSKI and W. KRAWCZYK, *Wiad. Techn. Uzbr.* **45**, 490 (1939).
25. F. TABOUIS, M. ORTIGUES and P. AUBERTEIN, *Mém. poudres* **33**, 59 (1951).
26. T. URBAŃSKI and W. MALENDOWICZ, *Roczniki Chem.* **18**, 856 (1938).
27. M. TONEGUTTI, *Z. ges. Schiess- u. Sprengstoffw.* **32**, 93 (1947).
28. L. MÉDARD, *XXVII Congrès Chimie Industr., Brussel, Chimie et industrie, No. spécial*, 81 (1954).
29. A. YA. APIN and YU. A. LEBEDEV, *Dokl. Akad. Nauk SSSR* **114**, 819 (1957).
30. T. URBAŃSKI, *Przemysł chem.* **20**, 117, 179 (1936); *Z. ges. Schiess- u. Sprengstoffw.* **33**, 41, 62 (1938).
31. H. KAST, *Angew. Chem.* **35**, 72 (1923).
32. T. URBAŃSKI and T. GALAS, *Compt. rend.* **209**, 558 (1939).
33. P. LAFFITTE and A. PARISOT, *Compt. rend.* **203**, 1516 (1936).
34. M. A. COOK, *The Science of High Explosives*, Reinhold, New York, 1958.
35. A. IZZO, *Riv. artiglieria e genio* 373 (1932).
36. K. K. ANDREYEV, *Thermal Decomposition and Burning of Explosives* (in Russian), Gosenergoizdat, Moskva-Leningrad, 1957.
37. Poudreries réunies de Belgique, Soc. An., Belgian Pat. 488943 (1949).
38. Technical Report P.B. 925, General Summary of Explosive Plants, D.A.G. Krümmel, Düneberg, Christianstadt, U.S. Dept. of Commerce, Washington, 1945; Technical Report P.B. 262, RDX Manufacture in Germany, U.S. Dept. of Commerce, Washington, 1945; W. DE C. CRATER, *Ind. Eng. Chem.* **40**, 1627 (1948).
39. A. H. LAMBERTON, *Quart. Rev.* **5**, 75 (1951).
40. G. F. WRIGHT, *Gilman's Organic Chemistry*, Vol. IV, p. 983, J. Wiley, New York, 1953.
41. E. L. HIRST, A. CARRUTHERS, W. J. DUNNING, J. K. N. JONES, H. D. SPRINGALL *et al.*, unpublished, according to A. H. LAMBERTON [39].

42. A. H. VROOM and C. A. WINKLER, *Can. J. Research* **28 B**, 701 (1950).
43. G. S. MYERS and G. F. WRIGHT, *Can. J. Research* **27 B**, 489 (1949).
44. W. J. CHUTE, D. C. DOWNING, A. F. MCKAY, G. S. MYERS and G. F. WRIGHT, *Can. J. Research* **27 B**, 218 (1949).
45. K. SINGH, *J. Sci. Ind. Research (India)* **A 15**, 450 (1956).
46. L. BERMAN, R. H. MEEN and G. F. WRIGHT, *Can. J. Research* **29 B**, 767 (1951).
47. W. J. CHUTE, A. F. MCKAY, R. H. MEEN, G. S. MYERS and G. F. WRIGHT, *Can. J. Research* **27 B**, 503 (1949).
48. K. W. DUNNING and W. J. DUNNING, *J. Chem. Soc.* **1950**, 2920, 2925, 2928.
49. P. P. KARPUKHIN and W. N. CHETYRKIN, *Trudy Kharkovsk. Khim.-Technol. Inst. Kirova* **4**, 143 (1944); *Chem. Abstr.* **42**, 5918 (1948).
50. W. J. DUNNING, B. MILLARD and C. W. NUTT, *J. Chem. Soc.* **1952**, 1264.
51. V. GILPIN and C. A. WINKLER, *Can. J. Research* **30 B**, 743 (1952).
52. M. KIRSCH and C. A. WINKLER, *Can. J. Research* **28 B**, 715 (1950).
53. T. URBAŃSKI, unpublished (1936).
54. F. GROTTANELLI, *Chimica e industria* **20**, 801 (1938).
55. W. H. SIMMONS, A. FORSTER and R. C. BOWDEN, *Ind. Chemist* **24**, 530, 593 (1948).
56. T. URBAŃSKI and K. SZYC-LEWAŃSKA, *Bull. Acad. Polon. Sci., sér. chim.* **6**, 165 (1958).
57. W. P. BINNIE, H. L. COHEN and G. F. WRIGHT, *J. Am. Chem. Soc.* **72**, 4457 (1950).
58. R. W. SCHIESSLER and J. H. ROSS, *Brit. Pat.* 595354 (1947); *U.S. Pat.* 2434230 (1948).
59. E. ARISTOFF, J. A. GRAHAM, R. H. MEEN, G. S. MYERS and G. F. WRIGHT, *Can. J. Research* **27 B**, 520 (1949).
60. A. GILLIES, H. L. WILLIAMS and C. A. WINKLER, *Can. J. Chem.* **29**, 377 (1951).
61. Technical Report P.B. 4272, Hexogen Manufacture in Bobingen, U.S. Dept. of Commerce, Washington, 1945; CIOS XXXII 8, G.m.b.H. zur Verwertung Chemischer Erzeugnisse, Fabrik Bobingen.
62. W. E. BACHMANN and J. C. SHEEHAN, *J. Am. Chem. Soc.* **71**, 1842 (1949).
63. W. E. BACHMANN, W. J. HORTON, E. L. JENNER, N. W. MACNAUGHTON and C. E. MAXWELL, *J. Am. Chem. Soc.* **72**, 3132 (1950).
64. W. E. BACHMANN, W. J. HORTON, E. L. JENNER, N. W. MACNAUGHTON and L. B. SCOTT, *J. Am. Chem. Soc.* **73**, 2769 (1951); W. E. BACHMANN and E. L. JENNER, *ibid.* **73**, 2773 (1951); W. E. BACHMANN, E. L. JENNER and L. B. SCOTT, *ibid.* **73**, 2775 (1951).
65. R. C. BRIAN, F. CHAPMAN, A. H. LAMBERTON, C. LINDLEY, P. G. OWSTON, J. C. SPEAKMAN and D. WOODCOCK, *Chemistry & Industry* **223** (1949).
66. F. CHAPMAN, *J. Chem. Soc.* **1949**, 1631; F. CHAPMAN, P. G. OWSTON and D. WOODCOCK, *ibid.* **1949**, 1647.
67. e.g. E. E. ROBERTS, unpublished.
68. R. A. MARCUS and C. A. WINKLER, *Can. J. Chem.* **31**, 602 (1953).
69. W. C. MCCRONE, *Anal. Chem.* **22**, 1225 (1950).
70. M. BEDARD, H. HUBER, J. L. MEYERS and G. F. WRIGHT, *Can. J. Chem.* **40**, 2278 (1962).
71. W. H. RINKENBACH in *Kirk & Othmer Encyclopedia of Chemical Technology* **6**, 41, Interscience, New York, 1951.
72. S. EPSTEIN and C. A. WINKLER, *Can. J. Chem.* **30**, 734 (1952).
73. J. CASON (and F. C. WHITMORE), *J. Am. Chem. Soc.* **69**, 495 (1947).
74. E. ATKINSON and F. C. WHITMORE, *J. Am. Chem. Soc.* **73**, 4443 (1951).
75. F. MAYER, *Ber.* **21**, 2883 (1888).
76. P. DUDEN and M. SCHARFF, *Ann.* **288**, 218 (1895).
77. W. E. BACHMANN and N. C. DENO, *J. Am. Chem. Soc.* **73**, 2777 (1951).
78. P. AUBERTEIN, *Mém. poudres* **33**, 227 (1951).
79. H. FICHEROULLE and A. KOVACHE, *Mém. poudres* **33**, 241 (1951).
80. P. GRIESS and G. HARROW, *Ber.* **21**, 2737 (1888).

81. R. CAMBIER and A. BROCHET, *Compt. rend.* **120**, 105 (1895).
82. J. ŠIMEČEK and Z. DOLEŽEL, in T. URBAŇSKI, *Chemie a Technologie Vybusin*, Vol. III, p. 98, SNTL, Praha, 1959.
83. L. MÉDARD and M. DUTOUR, *Mém. poudres* **37**, 19 (1955).
84. M. DELÉPINE, *Bull. soc. chim. France* [3], **15**, 1202 (1896).
85. M. DELÉPINE and M. BADOCHÉ, *Compt. rend.* **214**, 777 (1942).
86. L. MÉDARD and M. THOMAS, *Mém. poudres* **31**, 173 (1949).
87. J. ŠIMEČEK, *Chem. Listy* **51**, 1323, 1699 (1957).
88. J. ŠIMEČEK and ŠRAMEK, in T. URBAŇSKI, *Chemie a Technologie Vybusin*, Vol. III, p. 101, SNTL, Praha, 1959.



Part 2

PRIMARY EXPLOSIVES: INITIATORS

CHAPTER I

GENERAL INFORMATION

THE earliest mention of explosives are to be found in the alchemical writings of the first half of the seventeenth century. Basilius Valentinus [1] described "explosive gold" which was a complex explosive salt formed by dissolving gold oxide in ammonia. At that time it was widely known that this substance is easily exploded by heat or direct contact with a flame.

According to Romocki [2], in 1630, the Dutchman, van Drebbel was the first chemist to investigate mercury fulminate, and "explosive gold". The first description of the laboratory preparation of "mercury fulminate" is given in Kunkel's book *Laboratorium Chymicum* published in 1690 [3]. This substance was described again by Howard in 1799-1800 [4]. No further discoveries of other primary explosives were made until the development of modern chemistry.

The invention of percussion compositions for igniting powders is usually attributed to Forsyth [5]. In 1805 he employed pellets composed of a mixture of potassium chlorate and combustible materials, coated with wax to render them safer to handle, but even so they were still dangerous since the mixture was sensitive to friction. The first ignition caps were invented in the early nineteenth century. In these caps the ignitable composition was enclosed in a casing of brass or copper. This invention cannot be traced with any certainty to any individual. The literature on the subject names several chemists including Bellot and Egg in 1815 [5].

The first application of mercury fulminate in ignition caps is attributed to Wright [6] in 1823.

Prior to 1831, straws filled with blackpowder, or fuses, which were cords saturated with a powder mixture, were used for igniting high explosive charges. The rate of burning of these powder timetrains was very irregular and lead to a great many accidents due to premature explosions. In 1831, a considerable advance was made

by Bickford [7], who invented slow burning (safety) fuses, which comprised an inner core, filled with blackpowder, surrounded by layers of plaited jute.

Around 1860 Nobel [8] began to use a fuse with a small cartridge of blackpowder at the end which produced a more intense ignition, for detonating nitroglycerine. Subsequently he replaced the cartridges by caps and finally invented the detonator [9], by elongating the cap and considerably increasing the charge of mercury fulminate. Similar work was done by Andreyevskii in Russia [10].

Mercury fulminate is easy to produce, has been known since earliest times and is still widely used. The scarcity of mercury has however led to many attempts to replace this substance by something else, in particular by substances containing a different metal. Some success was achieved as a result of work of Will and Lenze [5] in 1892 on the application of heavy-metal azides as initiating agents.

Primary explosives are a group of substances which are highly sensitive to the action of mechanical shock and are readily ignited by direct contact with flame or electric sparks.

Special care should be taken, therefore, during their manufacture. The danger becomes greatest when the initiating substance is being transferred to the drier after it has been washed with water. From that time onwards all possible safety measures must be taken and strictly observed.

All operations must be handled from an adjacent room or at least from behind a strongly built wall or an armoured shield, progress being observed through a sight-glass or by television. Weighing and pouring materials etc., should also be carried out from behind a shield.

A plant used for drying, grinding, sieving, weighing and stirring primary explosives must be designed to minimize friction, and power units should be located in a separate building.

In such a plant, conditions are particularly favourable for the accumulation of static electricity, due to friction between the crystals themselves, and between the crystals and parts of the plant, even between the crystal and the air, during drying. All the parts of the plant should therefore be well earthed. If they are manufactured of non-conductive material, as for example, plastics, ebonite or leather, these materials should contain conductive substances such as graphite or aluminium dust, to help dissipate the static electricity generated.

If the rule that all the parts of the plant must be earthed is not observed, accumulation of static electricity may occur, and under these circumstances, initiators only need an electric spark to start them burning. Some of them, for instance lead styphnate, are particularly susceptible to ignition by sparks.

It is also desirable to cover the floors of any buildings in which initiators are housed with a conductive material. In order to minimize friction, the flooring material should be soft. Hence polyvinyl chloride or rubber containing aluminium powder or graphite, laid on earthed metallic tapes, are used. A floor that conducts electricity facilitates the escape of static electricity and also removes any danger which may arise from the building up of static charges on operators. According

to Freytag [11], a man walking on an insulated floor, covered, for example, with a woollen rug, amasses a static charge of 14,000 volts. It is obvious that a person so charged could, on approaching an earthed instrument, cause a spark capable of igniting a sensitive initiating compound.

Since accumulation of static electricity is favoured by dryness, moderate humidification of the atmosphere increases its conductivity, and thereby decreases the danger in handling initiating materials.

Recent technical literature discusses new methods of minimizing or even preventing the build-up of static electricity by using salts of radioactive elements to ionize the air introduced into the factory buildings.

It is also very important to destroy any explosive substances which may be entrained in liquid wastes and wash-water.

They can be settled out and subsequently precipitated. They should be destroyed by chemicals which decompose them. Mercury fulminate, for example, is decomposed by a solution of thiosulphate, and lead azide by dilute nitric acid plus sodium nitrite.

LITERATURE

1. BASILIUS VALENTINUS, according to FELDHAUS, *Z. ges. Schiess- u. Sprengstoffw.* 4, 258 (1909)
2. S. J. V. ROMOCKI, *Geschichte der Sprengstoffchemie*, Bd. I, Oppenheim (Schmidt), Berlin 1895.
3. KUNKEL, *Laboratorium Chymicum*, Hamburg, 1690.
4. HOWARD, *Phil. Trans.* 90, I, 204 (1800).
5. According to H. KAST, *Spreng- u. Zündstoffe*, Vieweg & Sohn, Braunschweig, 1921.
6. WRIGHT, *Phil. Mag.* 62, 203 (1823).
7. BICKFORD, Brit. Pat. 1659 (1831).
8. A. NOBEL, Brit. Pat. 2359 (1863); 1813 (1864).
9. A. NOBEL, Brit. Pat. 1345 (1867).
10. According to A. G. GORST, *Porokha i vzryvchatye veshchestva*, Oborongiz, Moskva, 1957.
11. H. FREYTAG, *Raumexplosionen durch statische Elektrizität*, Verlag Chemie, Berlin, 1938.

CHAPTER II

FULMINIC ACID AND ITS SALTS

FULMINIC ACID

FULMINIC acid $C \equiv NOH$ is a gaseous, highly toxic substance with an odour resembling that of hydrogen cyanide. It is isomeric with other acids of the same empirical formula $HCNO$. The chief of these is cyanic acid $HCNO$, which is obtainable only in the form of its salts; free cyanic acid is unstable. The action of inorganic acids on cyanates leads to the evolution of cyanic acid which hydrolyses to form carbon dioxide and ammonia:

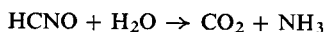
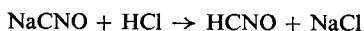

The treatment of cyanates with organic acids (oxalic acid, for example) in a non-aqueous medium, for instance by grinding the two together, does not result in the decomposition of cyanic acid, but in the formation of a trimer, cyanuric acid, to which the formula of the trioxymethylene derivative is attributed (I)

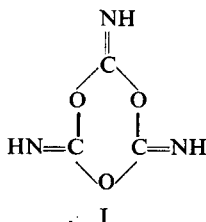

When distilled, this substance undergoes depolymerization, and isocyanic acid, a stable liquid with the structure (II), is formed at a temperature of $0^\circ C$:

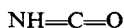

II

Its salts also exist in the form of a trimer, cyanuric acid (III), which is produced on heating the salts of isocyanic acid with acetic acid. Esters of cyanuric acid undergo isomerization when heated and are converted into esters of isocyanuric acid (IV):

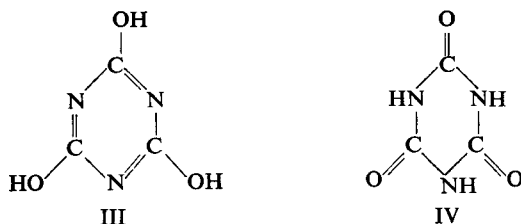

The free acid — a trimer of isocyanic acid — probably has the structure (IV). Cyanuric acids are of some importance as sources of initiating materials (cyanuric azide, for example, p. 194).

The salts of fulminic acid differ basically from those of isocyanic acid and its trimers.

The formula (V) attributed originally to fulminic acid, considers it to be an oxime of carbon monoxide [7]; a more recent interpretation suggests the formula (Va):

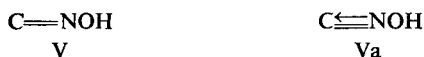

The linear structure of the fulminate ion

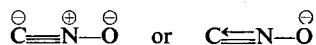

was recently confirmed by spectroscopic investigation of some salts of fulminic acid.

Singh [1] has examined infra-red spectra of mercuric, silver and lead fulminates, and Beck [2] those of sodium and potassium fulminates. The maxima 2147 and 1225 cm^{-1} were found to be characteristic of asymmetric and symmetric vibrations of the O—N—C group, respectively. The maximum 1181 cm^{-1} was assigned to the bending frequency of the same group [1]. Beck also found that the transient formation of an isomeric ion $\ominus\text{N}=\text{C}-\text{O}$ can occur on thermal decomposition of fulminates.

This kind of structure is also proved by the fact that chemically fulminic acid behaves as an unsaturated compound, adding hydrogen chloride at a temperature of 0°C , to form the crystalline chloroformoxime (VI):

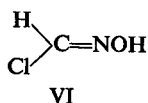

A certain amount of crystalline isocyanic acid is also produced. This substance has no explosive properties and according to Wieland [3] has the structure of furaxanedialdoxime (VII):

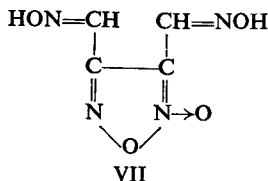

When mercury fulminate is boiled with water, polymerization occurs with the formation of salts of fulminic acid, which is probably a mixture of substances (VII) and (VIII). This compound hydrolyses to produce formic acid and hydroxylamine:

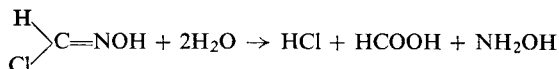

Thus, fulminic acid $\text{C}=\text{N}-\text{OH}$ (or $\text{C}\equiv\text{N}-\text{H}$) has been regarded as a substance analogous to hydrogen cyanide $\text{C}\equiv\text{N}-\text{H}$ (or $\text{C}\equiv\text{N}-\text{H}$). This analogy is also borne out by the facility with which fulminic acid forms complex compounds with for instance iron-sodium ferrofulminate, $\text{Na}_4\text{Fe}(\text{CNO})_6 \cdot 18\text{H}_2\text{O}$, analogous to sodium ferrocyanide.

It must be emphasized that the analogy between fulminic acid and hydrogen cyanide is very deep. Liquefied hydrogen cyanide (b.p. $+26^\circ\text{C}$) has explosive properties. This is explicable by the fact that like acetylene it is a strongly endothermic substance. The explosive decomposition of hydrogen cyanide proceeds theoretically according to the equation:

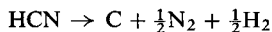

The quantity of heat evolved amounts to 1017 kcal/kg, the volume of gases evolved, V_0 , is 830 l./kg, the temperature is 2250°C . This was first reported by Walker and Eldred [4].

Wöhler and Roth [5] proved that liquefied HCN can be exploded by means of a blasting cap.

Wöhler calls attention to the fact that some cyanides of heavy metals, e.g. mercuric cyanide, are highly sensitive to friction and impact and may initiate detonation of liquefied hydrogen cyanide.

Liquefied or solid (m.p. -14°C) hydrogen cyanide is also capable of polymerization, a strongly exothermic reaction which may involve apparent explosion due to local overheating. Local overheating may also induce a genuine explosion, particularly in the presence of the cyanides of some heavy metals.

The unsaturated nature of fulminic acid accounts for its tendency to polymerize and suggests that polymers constitute the brown impurity produced in the manufacture of mercury fulminate. The ability of fulminic acid to polymerize is also proved by the formation of cyamelide (I). It has also been established that an ether solution of fulminic acid is converted into metafulminuric acid on standing:

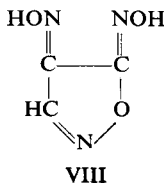

MERCURY FULMINATE

Mercury fulminate ($C\equiv NO$)₂ Hg is an initiating material of the greatest importance. It is obtained very simply by treating a solution of mercuric nitrate with alcohol in nitric acid. A method for preparing it was described in alchemical writings. This reaction, together with its product has been studied by a number of chemists, including Liebig [6], who gave an account of the elementary chemical composition of fulminate in 1823. Nothing was known of its structure until Nef's suggestion [7] in 1894, that fulminic acid is an oxime of carbon monoxide. This structure was subsequently supported for sodium fulminate by Wöhler and Teodorowicz [8]. More recent investigations altered these views, as described above (p. 133). The mechanism of reaction which results in the formation of mercury fulminate was reported by Wieland [9]. Solonina [10] made a detailed examination of its properties and its manufacturing technology.

According to Wieland, reactions between mercury nitrate, nitric acid and alcohol leading to the formation of mercury fulminate proceed as follows:

- (1) Oxidation of alcohol to acetic aldehyde



- (2) Nitration of acetic aldehyde to nitrosoacetic aldehyde



- (3) Isomerization of nitrosoacetic aldehyde to isonitrosoacetic aldehyde

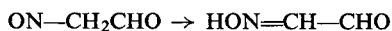

- (4) Oxidation of isonitrosoacetic aldehyde to the corresponding acid

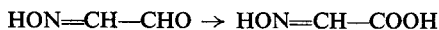

- (5) Nitration of isonitrosoacetic acid to nitrolactic acid

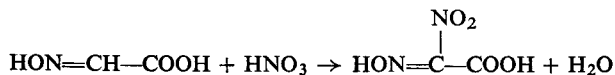

- (6) Decarboxylation of nitrolactic acid in methylnitrolic acid

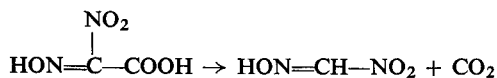

- (7) Decomposition of methylnitrolic acid into fulminic acid and nitrous acid

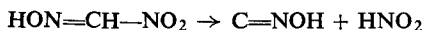

- (8) Formation of mercury fulminate

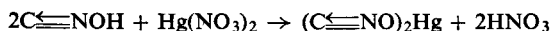

This reaction gives the volatile by-products: ethyl nitrate, ethyl nitrite and acetic acid, NO, NO₂ and CO₂.

One hundred and forty-two parts of mercury fulminate can be obtained from 100 parts of mercury. A considerable amount of oxalic acid, produced by oxidation, remains in the solution, hence crude mercury fulminate is washed with distilled water.

Beside this basic method of manufacturing mercury fulminate, which is widely practised, there are alternate processes. Angelico [11] recognized that mercury fulminate is formed by treating a mercury solution in an excess of nitric acid with a concentrated aqueous solution of malonic acid in the presence of a small amount of sodium nitrate. The reaction results in a considerable rise of temperature, CO₂ evolution and the precipitation of the fulminate (L. W. Jones [12]).

Nef [7] showed that the mercuric salt of nitromethane (obtained by the action of HgCl₂ on the sodium salt of nitromethane) decomposes when boiled with dilute hydrochloric acid to produce mercury fulminate. In all probability the following reaction takes place:

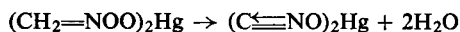

PHYSICAL PROPERTIES

Mercury fulminate consists of octahedral crystals, belonging to the orthorhombic system with the axial relationship $a : b : c = 0.712 : 1 : 1.353$ (Miles [13]). The pure substance crystallizes into the form of white, silky needles.

Commercial mercury fulminate may be greyish, pale brown or white, the colour depending on the method of its preparation. The reason for these different colours has been the subject of many investigations. A white product is formed when a certain amount of hydrochloric acid or cupric nitrate or chloride is added to the reaction mixture. A pale grey or a pale brown fulminate occurs on the application of pure reagents without the above-mentioned admixtures. The grey fulminate usually consists of very regular crystals (Fig. 28) whereas those of white fulminate are less regular (Fig. 29) due to the presence of impurities of mercuric chloride, or copper salts if copper has been added.

The grey or brown colour is usually uniform throughout the whole mass of crystals, although there are cases when the colour occurs in certain places only, forming stains or dyeing the edges of the crystals.

Kast [14] found that the grey mercury fulminate is the purest and contains 99.7–99.9% of mercury fulminate, soluble in hydrochloric acid. The insoluble residue is composed mainly of mercurous chloride which is probably derived from impurities of the starting substances.

The white fulminate contains 99.3–99.4% of the pure substance. The insoluble residue is again composed chiefly of mercurous chloride, but it also contains substances which turn dark under the influence of ammonia, hence the white product is less pure than the grey one. The more hydrochloric acid is added to the reaction mixture, the higher is the content of mercuric chloride.

It was believed at first that grey fulminate was contaminated with metallic mercury, since it had been observed that when it is dissolved in certain solvents a resi-

due of metallic mercury is obtained. Solonina [10] showed, however, that this residue is produced from both kinds of fulminate and that the mercury which constitutes an insoluble residue in ammonia and potassium cyanide solutions or in pyridine does not occur in the fulminate crystals but is formed as a result of decomposition

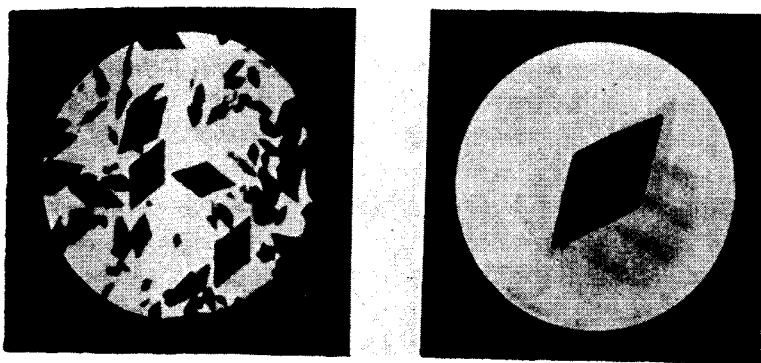

FIG. 28. Crystals of "grey" mercury fulminate, according to Kast [17].

by reaction with the solvent. Thus the idea that the presence of mercury in the crystals of grey fulminate causes the grey colour cannot be considered proven, although a number of authors still believe in it (Wöhler and Berthmann [15]). In point of fact, a dark grey product, copiously contaminated with mercury, may be



FIG. 29. Crystals of "white" mercury fulminate, according to Kast [17].

prepared by carrying out the reaction in dilute aqueous solution. The formation of mercury fulminate is then accompanied by the reduction of mercuric nitrate to metallic mercury. The same effect can be obtained by using an insufficient amount of nitric acid or too low a temperature of reaction. Such contaminated mercury fulminate cannot be used since it amalgamates with the metal body of the caps, causing their corrosion and may also form copper fulminate by reaction between the amalgam and mercury fulminate. The course of the reaction itself may also influence the colour of the product. According to Wöhler [16] the white coloured product may be obtained if acetaldehyde is used in the reaction instead of alcohol.

On the basis of all these experiments Kast [17] expressed the opinion that different colours are produced by differences in the size and shape of the crystals and not by impurities. This however appears to be incorrect. There seems every reason to believe that the grey and particularly the brown colour of mercury fulminate are produced by the presence of organic impurities, i.e. resinous product of the polymerization of fulminic acid (Marshall [18]). The white product, in Marshall's opinion, contains the same impurities, but in disguised form.

Apart from the impurities that influence its colour, mercury fulminate may contain a trace of mercuric oxalate, the presence of which was discovered by Shishkov [19] as early as 1856. Oxalic acid is always formed during the reaction as a by-product resulting from the oxidation reaction and according to Solonina the amount of oxalic acid formed is larger if hydrochloric acid is present in the reaction mixture.

Nicolardot and Boudet [20] found that mercuric nitrate may also be an impurity of mercury fulminate.

According to various authors, the specific gravity of mercury fulminate is:

4.42	(Berthelot and Vieille [21])
4.394	(Solonina [10], product recrystallized from an aqueous solution of sodium cyanide)
4.307	(Miles [13], product recrystallized from an aqueous solution of ammonia)

According to Patry [22] the crystallized product has a lower specific gravity (4.32) than the crude product (4.40).

The apparent density of loosely-poured fulminate depends to a great extent upon the size and shape of the crystals. According to various authors it may range from 1.22 to 1.60. A fine crystalline product has a low apparent density, a coarse crystalline product a high one. These variations are of great importance when loading caps with fulminate measured volumetrically. In detonators the density is usually as high as 2.5.

The solubility of mercury fulminate in water is low. According to Holleman [23], 100 ml of water dissolve:

at a temperature of	g
12°C	0.07
49°C	0.176
100°C	8

Mercury fulminate crystallizes from water as a yellow coloured product containing $\frac{1}{2}$ H₂O (Shishkov [19]). It was believed at first that the yellow colour is due to the presence of mercuric oxide resulting from the hydrolysis of the fulminate. It is now considered that this colour should be ascribed to the formation of products not fully defined and partly to the mercuric salts of metafulminuric acid (p.134). Furthermore on boiling in water, the hydrolysis of mercury fulminate may be fairly extensive.

Mercury fulminate dissolves in alcohol rather more readily than in water. The best solvent for fulminate is an aqueous solution of ammonia. At 30–35° a concen-

trated aqueous solution of ammonia dissolves a fourfold amount of mercury fulminate, but at 60°C decomposition ensues with the formation of urea and guanidine. From an ammonia solution fulminate can be crystallized either by evaporating off the ammonia, by diluting the solution with water or by acidifying in the cold with acid (e.g. acetic acid). Mercury fulminate also dissolves in acetone saturated with ammonia.

A good solvent for mercury fulminate is a mixture of a concentrated ammonia solution with alcohol and water (Miles [13]). According to Singh [24] the best results are obtainable by a mixture of the above components in the volume ratio 2 : 1 : 1.

Mercury fulminate dissolves in an aqueous solution of potassium cyanide (Steiner [25], Grigorovich [26]), to form a complex salt. According to Solonina the fulminate is best precipitated from this solution by treatment with dilute nitric acid. Thus, 12 g of mercury fulminate, dissolved in a solution of 6 g of KCN and 30 ml of water is diluted with water to 100 ml and treated carefully with 50 ml of nitric acid, i.e. 10 ml of acid, s.g. 1.40 diluted with water to 50 ml.

Pyridine is also a good solvent for mercury fulminate. 14.5 g of mercury fulminate may be dissolved in a 1 g of pyridine on moderate heating. The fulminate may be recovered if the solution is poured into water. Large crystals, an addition compound of mercury fulminate with pyridine, then separate. This compound loses pyridine on drying.

Mercury fulminate also dissolves in many solutions of various salts, but in some of them (e.g. potassium iodide, sodium thiosulphate) it undergoes rapid decomposition.

Majrich [27] established that ethanolamine or an aqueous solution of ammonia with ethanolamine are good solvents for mercury fulminate. By dilution with water or acidification of the solution, mercury fulminate is precipitated in a highly pure form, suitable for further use.

Mercury fulminate crystals are not so hard as those of lead azide (Todd and Parry [28]).

According to Yuill [29] the specific heat of mercury fulminate is:

at 110°C	0.119 cal/g
at 125°C	0.120 cal/g

Its thermal conductivity according to Belayev and Matyushko [30] is 0.00029.

CHEMICAL PROPERTIES

As previously stated, mercury fulminate is hydrolysed by heating in water; in boiling water hydrolysis is very rapid. Farmer [31] noticed that on heating with water under pressure, mercury fulminate undergoes decomposition to metallic mercury. Marked decomposition also takes place on heating or standing for long periods at room temperature in an aqueous solution of ammonia or potassium

cyanide, or in pyridine, i.e. solvents for fulminate. When purifying the fulminate by crystallization, special care must therefore be taken to see that temperatures during dissolution and precipitation are as low as possible and that the latter follows the former with the greatest possible speed.

After a 14 day immersion of mercury fulminate in an aqueous solution of potassium cyanide, precipitation can be inhibited by the addition of nitric acid.

On boiling the solution takes on a violet colour. Dissolved in an aqueous solution of ammonia, fulminate decomposes even after 12 hr. On boiling a pyridine solution of fulminate, complete decomposition occurs.

Mercury fulminate is relatively resistant to the action of dilute acids, in particular to that of nitric acid, but concentrated acids cause decomposition. Thus, under the influence of nitric acid decomposition occurs with evolution of NO, CO, acetic acid and mercuric nitrate. Under the influence of concentrated hydrochloric acid free fulminic acid is evolved (with an odour resembling that of hydrogen cyanide) as well as the decomposition products: hydroxylamine hydrochloride, formic acid, mercuric chloride (Carstanjen and Ehrenberg [32]; Scholl [33]). Mercury fulminate explodes on direct contact with concentrated sulphuric acid.

Strong alkalis decompose mercury fulminate easily. Heating with aniline leads to the formation of phenylurea, diphenylguanidine and metallic mercury (Steiner [34]).

On treatment with phenylhydrazine, mercury fulminate undergoes reduction to free mercury. The phenylhydrazine changes colour from olive, grey (at the moment when mercury is set free) to reddish-brown. Several hours after the addition of alcohol and dilute sulphuric acid, a red-violet colour appears (Langhans [35]). This reaction may be used for the qualitative detection of mercury fulminate.

Mercury fulminate undergoes rapid decomposition by the action of ammonium sulphide to form mercuric sulphide. The fulminate dissolves in sodium thiosulphate, according to the reaction:

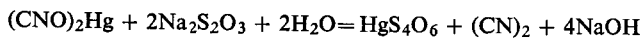

This reaction may be used to determine fulminate quantitatively by back titration of the sodium hydroxide formed. It can also be used to destroy fulminate residues and waste material. The impurities in mercury fulminate (oxalate and nitrate) are insoluble in thiosulphate.

Reactions with metals. When mercury fulminate is boiled with water containing metallic suspensions, the majority of metals (e.g. aluminium, zinc, copper), form their fulminates and mercury is precipitated. Reaction can also occur at room temperature, except with nickel. Other metals may be ranged according to increasing reactivity: silver, tin, bismuth, cadmium, iron, lead, copper, zinc, brass, aluminium. With aluminium, the reaction takes only a few hours, yielding a large amount of Al_2O_3 .

A similar reaction was observed when mercury fulminate was kept in contact with metals in a damp atmosphere. Aluminium gave a white bloom after only four

days. Iron and brass became slightly corroded in six days and zinc and lead in 14 days. The remaining metals, i.e. copper, cadmium, tin and silver showed no change after 28 days (Langhans [36]).

Chemical stability and behaviour at high temperatures. Mercury fulminate undergoes marked thermal decomposition even at 50°C. Rathsburg [37] found that a sample of the technical product stored at 50–60°C for 6 months in a dry atmo-

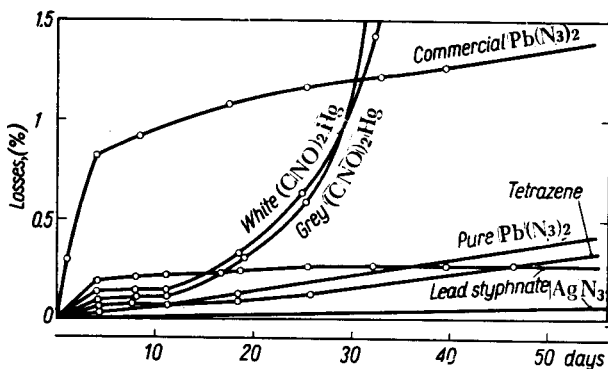

FIG. 30. Comparison of the rate of decomposition of mercury fulminate and other primary explosives at 75°C, according to Wallbaum [38].

sphere lost 3.6% in weight, while in a damp atmosphere 7.6% was lost. A recrystallized sample, however, showed a greater stability, under the same conditions only losing 0.2–0.5% in weight.

Heating mercury fulminate at 75°C causes distinct decomposition. According to Wallbaum [38], during the first 10 days the loss in weight is not significant (*ca.* 0.12%), but after that the rate of decomposition begins to increase. After 46 days the loss in weight reaches 8%. The shapes of the decomposition curve (Fig. 30) clearly shows the increasing rate of decomposition. The curve for mercury fulminate compares unfavourably with that for other initiating materials, i.e. lead and silver azides, lead styphnate and tetrazene.

Hess and Dietl [39] found that 0.5 g samples of fulminate at 90–95°C undergo partial decomposition to form substances with reduced explosive properties after 35–40 hr; they also showed that after 75–100 hr a brown-yellow powder of low inflammability is produced.

Langhans [40] examined the changes which occur in white and grey mercury fulminates during heating at 90°C under reduced pressure. After 100 hr a brown-yellow, non-explosive substance was formed which retained the original crystalline form. This substance was named mercury pyrofulminate by the author. It differs from the starting substance by containing more mercury (76.4%) the empirical formula being $\text{Hg}_4\text{C}_5\text{O}_5\text{N}_7$ and by being insoluble in an aqueous solution of ammonia and in pyridine.

Aqueous solutions of organic acids such as formic, acetic, and oxalic, decompose mercury fulminate, forming the corresponding mercuric salts. On the other hand, the action of dilute inorganic acids involves decomposition with formation of CO_2 .

The decomposition of fulminate heated at 60–100°C under a reduced pressure (5 mm Hg) was investigated in detail by Farmer [31]. At 80°C the brown fulminate began to decompose with the evolution of gas after the induction period was over, i.e. after 80 hr, whereas decomposition of the white fulminate began after a much longer induction period, lasting 140 to 190 hr, after which it then proceeded with the evolution of gas which was almost exclusively carbon dioxide. The rate of decomposition of the white fulminate was higher at this stage than that of the grey fulminate. The grey fulminate was transformed into a non-explosive product after about 200 hr from the beginning of decomposition.

Farmer quotes the following figures for the time required for the production of 5 cm³ of gas by heating mercury fulminate (this corresponds to the decomposition of 11% of substance):

Brown fulminate:	at 60.0°C	1227 hr
	at 89.6°C	39 hr
White fulminate:	at 60.0°C	2010 hr
	at 89.6°C	67 hr

The difference in the behaviour of the two modifications was due largely to the differences in crystal size. Fine fulminate, ground under water decomposes more rapidly than a coarse crystalline product.

Farmer's experiments were repeated and extended by Garner and Hailes [41]. They examined the behaviour of mercury fulminate at about 100°C and came to the conclusion that during the initial induction period, decomposition is accompanied by a slow evolution of gas at a constant velocity (linear decomposition). At the end of this phase the main decomposition period begins with an increased rate of gas evolution. The authors noticed that if the fulminate is finely ground, rapid evolution of gas begins at once, without any initial period.

Garner and Hailes believe that decomposition proceeds by a chain mechanism with a constant coefficient of branching.

Grinding increases the number of centres at which the reaction originates. Since the decomposition reaction passes from one grain to another at the points where thin surfaces are in contact, grinding which increases the surface area, would be expected to have the effect described above.

A number of later authors, e.g. Prout and Tompkins [42], Vaughan and Phillips [43] have confirmed that the thermal decomposition of mercury fulminate is a chain reaction.

In a later work Garner and Haycock [44], came to the conclusion that the first 10% of the substance undergoing the accelerated decomposition breaks down according to the cubic equation (1):

$$p - p_0 = k_3(t - t_0)^3 \quad (1)$$

where: p is the pressure of gaseous decomposition products during time t , p_0 and t_0 are the pressure of gases and the time at the moment of completion of linear decomposition (initial period) i.e. at the beginning of accelerated decomposition, and k_3 is the constant for the reaction rate.

On the basis of this equation the authors draw the conclusion that after completion of linear decomposition, i.e. at the point p_0, t_0 , spherical nuclei of decomposition are formed.

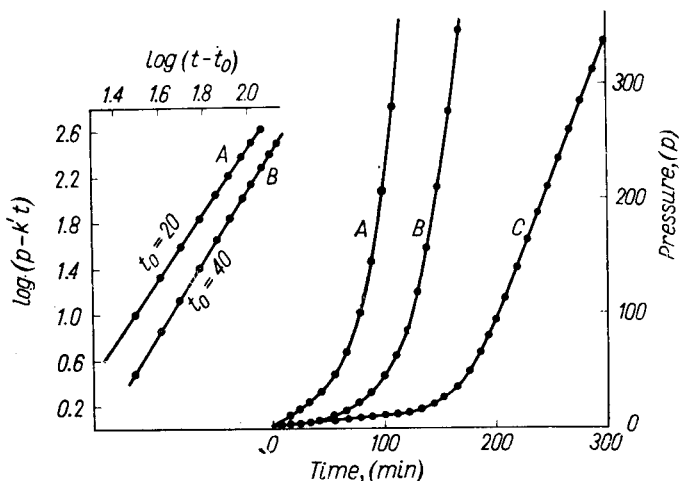

FIG. 31. Influence of various methods of treatment on the thermal decomposition of mercury fulminate, according to Bartlett, Tompkins and Young [45]. A—pre-irradiated, B—crushed, C—aged.

Bartlett, Tompkins and Young [45] suggested a modified (2) equation of Garner and Haycock:

$$p - p_0 = k_3(t - t_0)^3 + k_1t \quad (2)$$

Here k_1 is the constant for the linear reaction.

These authors studied the influence of the various methods of treatment on the thermal decomposition of mercury fulminate crystals. This is shown in the graph (Fig. 31).

Curve A represents the decomposition of mercury fulminate irradiated with ultra-violet rays, curve B the decomposition of ground mercury fulminate, and curve C the decomposition of ordinary (freshly-prepared) mercury fulminate.

According to Garner's calculations [44, 46] the activation energy of the accelerated decomposition period is about 32 kcal/mole. Vaughan and Phillips [43] gave the figure 25.4 kcal/mole and $\log B = 11.05$.

Bartlett *et al.* found for the activation energy the figure of 27 kcal/mole and for linear decomposition the figure of about 5 kcal/mole.

Singh [24] noticed that when heated for a few minutes at a temperature nearing that of immediate decomposition mercury fulminate crystals undergo decomposi-

tion first along crystallographic planes (010) and (100) on the surface of the crystals. Thus crystals heated, for instance, for 7 min 36 sec at 160°C undergo the cracking shown in Fig. 32 (b). (The same crystal before heating is shown in Fig. 32 (a)).

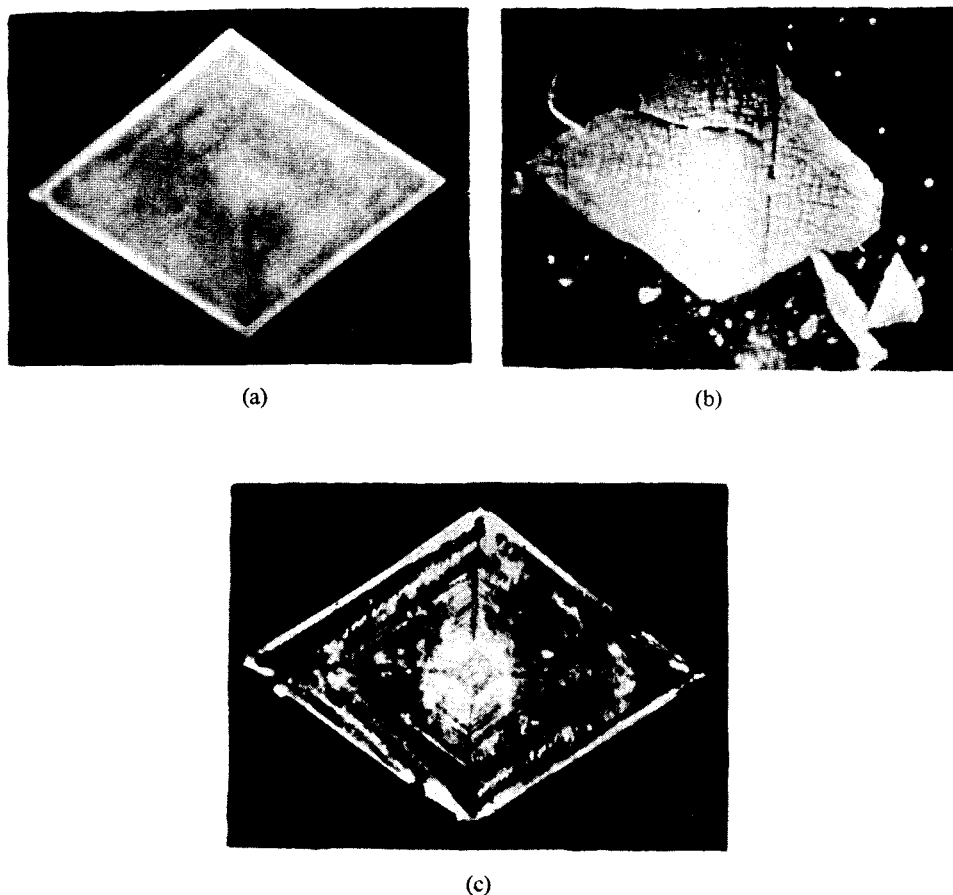

FIG. 32. Crystals of mercury fulminate: (a) before heating, (b) after heating at 160°C for 7 min 36 sec, (c) after heating at 80°C for 96 hr, according to Singh [24].

Similar behaviour in silver azide crystals was observed by Bowden *et al.* [47].

When crystals of mercury fulminate are heated at lower temperatures the decomposition reaction is localized mainly around lattice defects such as growth marks on the surface of crystals or points where dislocations emerge at the surface (Fig. 32 (c)).

The nuclei formed in crystals of mercury fulminate are yellowish-brown. They probably consist of Langhans' mercury pyrofulminate [40].

The admixture of various substances acts in different ways on the decomposition rate of fulminate: inorganic acids accelerate decomposition; organic acids

exert no influence whatever while organic bases sometimes accelerate decomposition considerably. E.g., the addition of 10% of centralite leads to the explosion of fulminate heated for 3 hr at 80°C.

According to various authors, the ignition temperature of mercury fulminate is 187–190°C on rapid heating; on heating at a rate of 5°C/min it is 160–165°C. A test sample, when thrown onto a metallic surface heated to 215°C, explodes



FIG. 33. Cracks produced in mercury fulminate crystals by exposure to ultra-violet light (500 \times), according to Tompkins *et al.* [45].

after 5 sec, while an immediate explosion takes place on throwing a test sample on a surface heated to 277°C. On a surface heated to 139°C the explosion occurs after 39 min; at lower temperatures there is no explosion at all (data according to Laffitte and Patry [48]).

The behaviour of mercury fulminate at high temperatures depends on its purity. The recrystallized substance explodes immediately on a surface heated to 287°C.

Ignition depends on the size of the test sample used. A 10 g sample explodes after about 7 hr of heating at 115°C, while smaller ones decompose completely at 132°C without exploding.

Evans and Yuill [49] investigated the ignition of mercury fulminate by the adiabatic compression of the atmosphere surrounding it. They calculated that a 50% response corresponds to a temperature of 530°C.

The action of light. Mercury fulminate is sensitive to sunlight. Farmer found that on exposure to the sun's rays for 5 weeks in summer a test sample of fulminate showed considerable decomposition with gas evolution.

Berchtold and Eggert [50] and Eggert [51] established that mercury fulminate (like silver fulminate and other primary explosives) is exploded when strongly irradiated. To explode mercury fulminate a light with an intensity of 1.65 J/cm^2 is required (to explode silver fulminate— 2.1 J/cm^2).

According to Patry [22] fulminate darkens under the influence of irradiation by a mercury arc. After a month test samples become almost black and the mercury content increases from 70.8 to 71.3. As on heating, the crystalline structure remains unchanged but the optical properties of the crystals undergo alteration.

According to Tompkins *et al.* [45] crystals of mercury fulminate exposed to ultra-violet light (wavelength 2537 \AA) develop cracks, roughly parallel and about 10μ apart (Fig. 33). The cracks occur preferentially at points of weakness and high reactivity, i.e. at points where sub-grain boundaries emerge at the surface; it is at such sites that photolysis is most likely to occur. A similar phenomenon of cracking under the action of high temperature was described by Singh [24] (p. 144, Fig. 32).

According to Kaufman [52] strong γ -radiation (on average 10^5 r per hour) can decompose mercury fulminate. Mercury fulminate evolves large amounts of gas during irradiation and eventually loses its explosive properties.

EXPLOSIVE PROPERTIES

The densities of loading for mercury fulminate obtainable by applying different pressures are tabulated below:

Pressure kg/cm^2	Density
200	3.0
660	3.6
1330	4.0
3330	4.3

Under a pressure greater than 1660 kg/cm^2 mercury fulminate becomes "dead pressed" i.e. takes fire with difficulty and burns without detonation.

According to Gorst [53] mercury fulminate pressed at 500 kg/cm^2 gives 3% misfires following flame ignition, at $600\text{--}650 \text{ kg/cm}^2$ it gives 5% and at 3000 kg/cm^2 almost 100% misfires. In detonators, therefore the fulminate is compressed under pressures of $250\text{--}350 \text{ kg/cm}^2$.

The sensitiveness of mercury fulminate to penetration by a striker depends upon the pressing pressure. Under pressures up to 750 kg/cm^2 the sensitiveness to perforation rises with the increase of pressing pressure. For pressures between 700 and 750 kg/cm^2 an optimal sensitiveness to perforation is observed, and at still higher pressure, the sensitiveness decreases and finally disappears at about 2000 kg/cm^2 .

The most important explosive property of mercury fulminate is that its burning with a moderate rate, started by ignition, impact or friction, is easily converted into detonation. According to Patry [22], a charge of mercury fulminate (of density 1.25) in glass tubes of diameter 3–12 mm, when ignited at one end by the flame of a blackpowder fuse, burns over a certain distance (up to 30 cm at a small diameter of tube, and about 3 cm in one of larger diameter) with a moderate rate, that varies from 10 m/sec in the narrower tube to 20 m/sec in the wider tube. A detonation wave then arises which moves with a rate that ranges between 2250 and 2800 m/sec (the higher rate occurs in the larger diameter tubes). If the tube is very small, with a diameter less than 3 mm, no detonation wave may be produced.

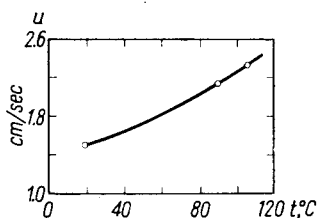

FIG. 34. Rate of burning of pressed mercury fulminate against initial temperature, according to Belayev and Belayeva [54].

Belayev and Belayeva [54] studied the influence of the initial temperature on the rate of burning of mercury fulminate, pressed into pellets. The results are shown in Fig. 34. A 100°C temperature increase in the mercury fulminate accelerated the rate of burning approximately 1.7 times. The authors also investigated the rate of burning of mercury fulminate at various temperatures, and expressed this relationship by the following equations:

$$\begin{array}{ll} \text{at } 20^{\circ}\text{C} & u = 0.47 + 1.05 p \\ \text{at } 90^{\circ}\text{C} & u = 0.65 + 1.44 p \\ \text{at } 105^{\circ}\text{C} & u = 0.71 + 1.60 p \end{array}$$

where u = the linear rate in cm/sec

p = the pressure in kg/cm²

The rate of detonation, as reported by various authors, ranges from 2250 to 6500 m/sec, depending on the density and the diameter of loading.

According to Kast and Haid [55] the rate of detonation against the density of mercury fulminate is related as follows:

Density	Rate of detonation m/sec
1.25	2300
1.66	2760
3.30	4480

At the Chemisch-Technische Reichsanstalt [56] the figures given on p. 148 were found for the rate of the detonation of mercury fulminate, pressed into detonators:

Density	Rate of detonation
	m/sec
3.07	3925
3.96	4740

A mixture of mercury fulminate containing 10% of KClO_3 detonates at a density of 3.16 with a rate of 4090 m/sec.

Patry [22] quotes the following rates of detonation in glass tubes (Table 23).

TABLE 23

THE RATE OF DETONATION OF MERCURY FULMINATE (ACCORDING TO PATRY [22])

Diameter of tube in mm	9	9	13	13	13	7.5
Density of loading	0.85	1.25	1.0	1.35	1.45	1.45
Rate of detonation in m/sec	2270	2700	2500	3000	3300	2700

According to other data the rate of detonation is 3975 m/sec at a density of 3.0 and 5400 m/sec at a density of 4.2.

234 cm^3 of gas are formed from the detonation of 1 g of mercury fulminate in an atmosphere of nitrogen. The gas consists of:

CO_2	0.15%
CO	65.7%
N_2	32.25%
H_2	1.9% (Berthelot and Vieille [21])

This conforms to the decomposition equation:



The calculated heat of decomposition is 114.5 kcal/mole (mercury as liquid) or 99.1 kcal/mole (mercury as vapour). When based on 1 kg of fulminate the corresponding figures are: 403 kcal and 349 kcal.

Kast [17] reports the following physical constants for mercury fulminate:

heat of formation	-221.5 kcal/kg ($-\Delta H_f = 62.9$ kcal/mole)
heat of explosion	357 kcal/kg
volume of gases (V_0)	316 l./kg
temperature of explosion (t)	4350°C(?)
specific pressure (f)	5530 m

According to the same author expansion in the lead block is 110 cm^3 .

The sensitiveness of mercury fulminate to impact and friction is high. The height from which a weight must be dropped to cause explosion is however not the same in reports by different authors. E.g. Stettbacher [57] states that fulminate was exploded by a 2 kg weight from a drop of 4 cm and nitroglycerine by the same weight from a drop of 6 cm. According to R. Robertson [58] fulminate exploded on impact from a drop only 10% of that necessary to explode picric acid.

Fulminate is desensitized by the addition of water. When it contains 5% of water it only partially detonates on impact; at 10% water content it decomposes without explosion and 30% of water prevents its decomposition. These results, however, refer to small scale tests, on a large scale they may be rather different. Substances such as oils, glycerine and paraffin act similarly as desensitizers. Fulminate containing 20% of high-melting paraffin wax was used for the manufacture of a detonating fuse, employed in Austria. Fulminate so phlegmatized is insensitive to moderate impact and friction, but is detonated by a blasting cap.

TOXICITY

Mercury fulminate has a sweetish "metallic" taste. When administered orally it is as poisonous as the majority of mercury compounds. Since, however, it is very sparingly soluble in water its toxicity through contact with the skin is insignificant. Nor is it toxic to lower plants, e.g. moulds often form on the moist bags in which mercury fulminate is stored.

Poisoning from mercury does occur, however, among workers employed in the first stages of production, when handling mercury.

MERCURY FULMINATE MANUFACTURE

There are numerous specifications for the technical manufacture of mercury fulminate. They may be divided into three groups:

- (1) methods in which a cold solution of mercury in nitric acid is employed;
- (2) methods in which a warm solution of mercury in nitric acid is employed;
- (3) methods, in which substances to bleach the product are included in addition to the essential raw materials: a mercury solution in nitric acid and ethyl alcohol.

The most important safety consideration in manufacturing fulminate is to ensure that only very small quantities (usually limited to 500 g of mercury) are produced in each reactor. Since mercury and mercuric nitrate readily react with metals the manufacture has to be carried out in glass reactors (retorts or flasks). A very pure product is thereby obtained and safety is ensured by the absence of metallic parts, against which friction and impact would be dangerous.

(1) One of the earliest descriptions of the manufacture of mercury fulminate given by Chevalier [59] is as follows: 300 g of mercury are dissolved in 3000 g of cold nitric acid (54% HNO_3 , s.g. 1.34) and the solution is poured into a flask containing 1900 g of 90% alcohol. After few minutes a vigorous reaction begins and crystals are precipitated. On completion of the reaction 238 g and 158 g of alcohol are added in turn. The fulminate is filtered off through a cloth filter and carefully washed free of acid with water. The yield is 118–128 parts of fulminate per 100 parts of mercury, i.e. 83–90% of theoretical.

Too large a quantity of cold alcohol added during the reaction may cause the formation of contaminated fulminate.

(2) Chandelon's method [60] is more widely used. Here 1 part by weight of mercury is dissolved in 10 parts of nitric acid (65% HNO_3 , s.g. 1.40) by moderate heating; the solution, heated to 55%, is poured into a flask or retort with a capacity at least 6 times that of the liquid, containing, apart from the above mentioned solution, 8.3 parts of 87% alcohol. The reactor is connected by a vent pipe with stoneware jars and a cooling tower in which the vapours evolved during the reaction are condensed.

After approximately 15 min the reaction begins, as shown by the evolution of gas. The liquid soon begins to boil, and the reactor fills with white vapour. The

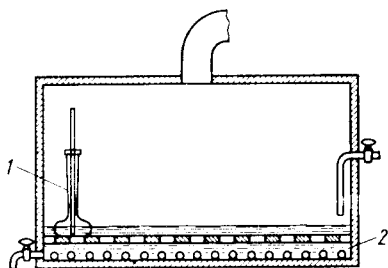

FIG. 35. Fume-cupboard with long necked flask (1) and heaters (2) for dissolving mercury in nitric acid, according to Budnikov *et al.* [61].

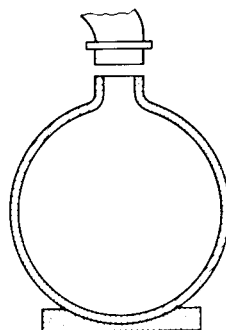

FIG. 36. Reaction flask, according to Budnikov *et al.* [61].

violence of the reaction may be suppressed by the addition of cold alcohol, but too large an addition may excessively inhibit the reaction and may lead to the formation of free mercury, which contaminates the product.

The fulminate is precipitated in the form of greyish needles. When the reaction is complete, the reactor is allowed to stand for approximately 30 min while the contents are cooled. 1–2 l. of water are then poured in and the liquid is decanted from above the precipitated crystals. The precipitate is transferred to a cloth filter and washed with distilled water until completely free of acid. The product is then screened on a silk sieve (approximately 100 mesh/cm²) which retains the larger crystals. The smaller crystals are collected for direct use. The large ones are ground under water, passed through the same sieve and added to the previous batch. 125 parts of fulminate are obtainable from 100 parts of mercury, which corresponds to a yield of 88%.

The condensate that collects in the jars and tower consists of ethyl nitrate and nitrite, acetaldehyde and unreacted alcohol. The vapours of these substances are noxious so care must be taken that the apparatus is tightly closed.

(3) Solonina [10] gives two methods for the manufacture of mercury fulminate: the first (a) produces a white fulminate and the second (b) a grey one.

(a) 500 g of mercury is dissolved in 4500 g of nitric acid (62% HNO_3 , s.g. 1.383); 5000 cm^3 of 92–95% alcohol to which 5 g of copper dissolved in 5 g of hydrochloric acid (23% HCl , s.g. 1.115) has been previously added, is poured into the solution.

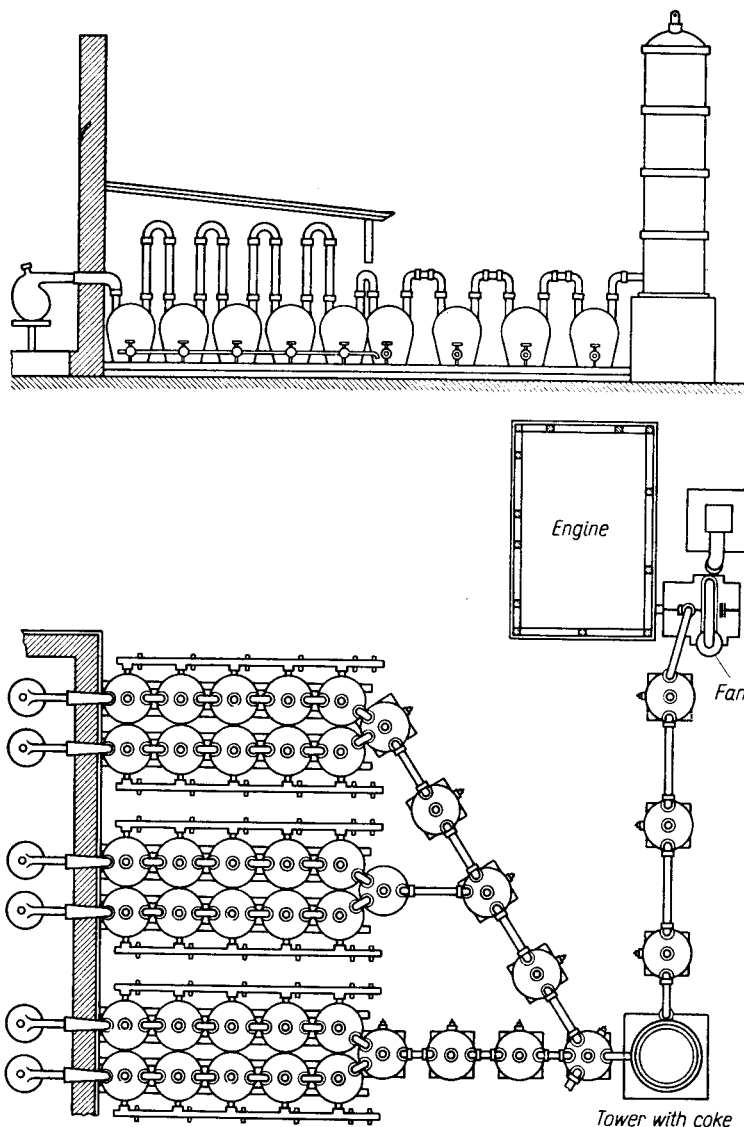

FIG. 37. A lay-out of the manufacture of mercury fulminate, according to Kast [17].

(b) 400 g of mercury is dissolved in 4200 g of nitric acid (62%) and 4000 cm^3 of 96% alcohol is then added.

In both methods the solution of mercury in nitric acid is heated cautiously to 50–56°C and the added alcohol to 40°C.

(4) According to a method employed in German factories (Kast [17]) 150 g of mercury is dissolved in 1072 cm³ (1500 g) of nitric acid (65% HNO₃, s.g. 1.40) and 1500 cm³ of 79.5% alcohol is added.

The temperature of the mercury solution lies between 40 and 55°C, that of the alcohol between 20 and 35°C. A grey product is formed. In order to obtain a white

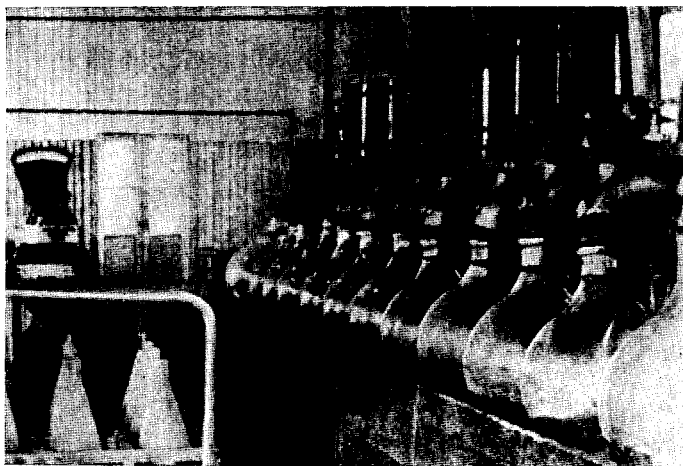

FIG. 38. General view of plant for manufacturing mercury fulminate in Atlas Powder Company, according to Davis [62]. On the left, conical flasks with mercury nitrate in nitric acid. On the right, reaction flasks.

product, a little concentrated hydrochloric acid, s.g. 1.185 is added to the alcohol before the reaction.

The series of figures explains various stages of the manufacture. Figure 35 shows a fume cupboard with long-neck flask for dissolving mercury (and small amount

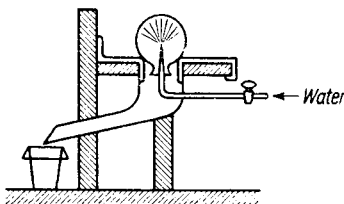

FIG. 39. Removal of mercury fulminate from the reaction flask to a rubber bucket, according to Budnikov *et al.* [61].

of copper) in nitric acid with the addition of a small amount of hydrochloric acid. Figure 36 shows a thick walled flask in which mercury fulminate is produced. The lay-out of reaction retorts, condensation jars and a cooling tower is given on Fig. 37, and a general view of the reaction flasks on Fig. 38.

Figure 39 shows a method of transferring mercury fulminate from the reaction flask to a rubber bucket. After preliminary washing in a vacuum filter, mercury fulminate can be transferred for final washing in the apparatus shown in Fig. 40

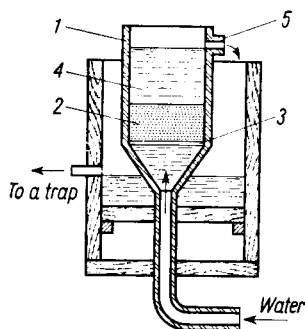

FIG. 40. Washing apparatus, according to Budnikov *et al.* [61]: 1—glass funnel, 2—mercury fulminate, 3—filter plate, 4—wash-water, 5—over-flow of wash-water.

in which water passes upwards through the fulminate layer, until the product is free of acid (this usually requires 40–60 min).

Storage and the further processing of mercury fulminate

Mercury fulminate prepared by one of the methods outlined above is tested to check the acid content and the content of other mercury compounds. When tested with litmus paper, the moist product should give a neutral reaction. A 5 g test sample mixed with 2 g of sodium hydrogen carbonate should not give a black or bluish tint.

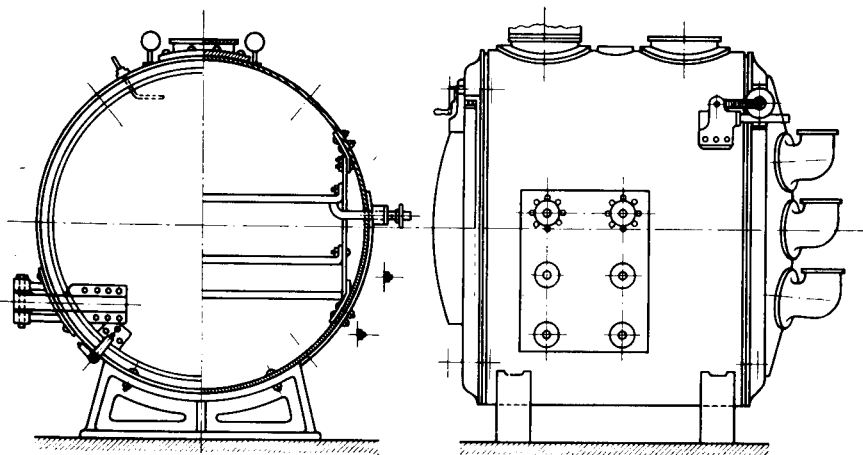

FIG. 41. Vacuum drier of mercury fulminate, according to Budnikov *et al.* [61].

Mercury fulminate containing about 50% of water is stored in glass jars or in linen or linen-rubberized bags placed in bakelite, bakelized cardboard or paraffinized boxes loosely covered with a lid. In this condition it can also be transported.

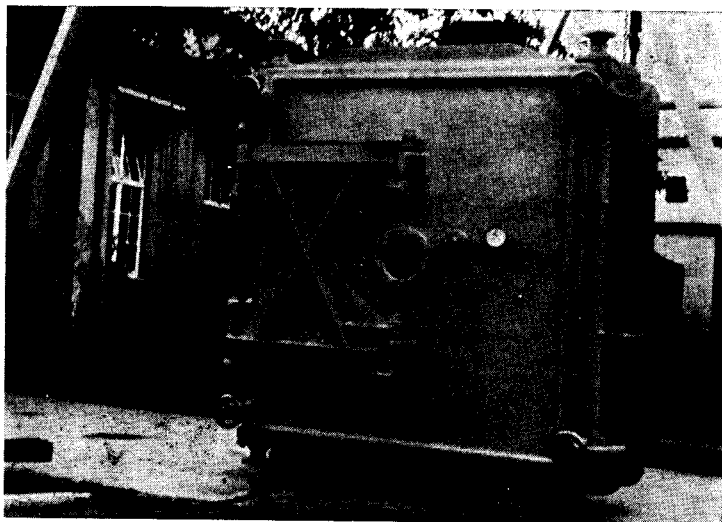

FIG. 42. Vacuum drier. Courtesy H. Orth G.m.b.H., Ludwigshafen-Oggersheim.

After accurate determination of its moisture content the fulminate may be used for the manufacture of mixtures by the so-called wet method. Alternatively it can be dried before mixing.

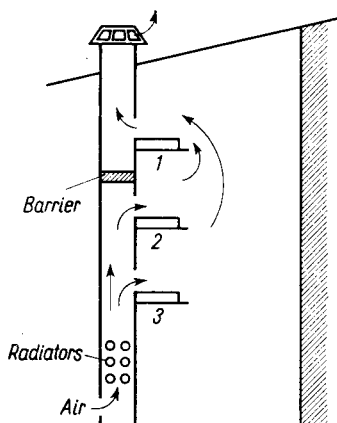

FIG. 43. Diagrammatic view of a drier with natural draught for mercury fulminate, according to Vennin, Burlot and Lécorché [66].

Drying mercury fulminate has always been a difficult problem. For a long time cylindrical vacuum driers (Fig. 41) were used in which the suction effect of the vacuum pressure (100–200 mm Hg), normally held the lids tightly in place.

In the event of an explosion the lids were blown off, and this sometimes prevented the destruction of the drier. The method was not very safe, however, especially when drying other primary explosives. The fulminate was dried at a temperature between 35 and 45°C.

Another former method for drying mercury fulminate in a warm air stream made use of a natural draught (Fig. 43). The fulminate is spread in thin layers over

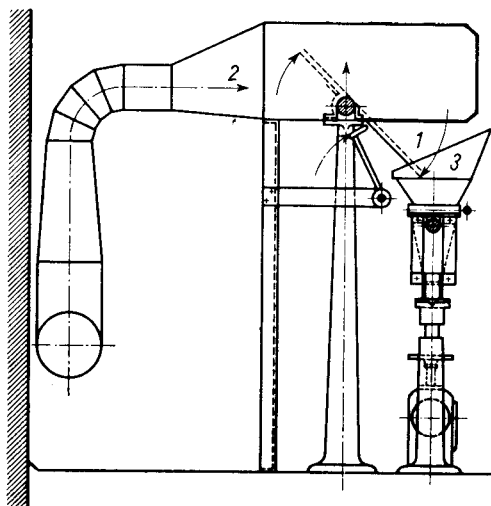

FIG. 44. Diagrammatic view of a German brattice drier for primary explosives with screening of the product [67].

frames wrapped with silk and arranged on shelves (1) (2) (3). Each frame contains approximately 1.5 kg of fulminate.

Brattice driers, incorporating a device for removing the dried material (Fig. 44) have been used in Germany. The moist material, spread in a thin layer over cloth stretched on wooden frames (1), is dried in warm air supplied via the ducting (2) at a rate of about 0.5 m/sec. Next to the frame on which the material is dried there is a tin funnel (3) with a built-in sieve in its base. This funnel is connected with the ventilating duct by a flexible tube. Each frame (1) contains about 1.2 kg of fulminate (dry substance). To dry a batch of fulminate at 65–70°C takes 1–1.5 hr.

After drying the material is cooled in a current of cold air produced by introducing cold water into the system that normally produces warm air. Since the dried material may become electrically charged even though the frame on which it was dried is earthed, to permit the charge to escape, a certain amount of water is sprayed over it from a water feed nozzle located near the ducting supplying the drying air. These operations take approximately 0.5 hr.

After cooling the frames (1) are tilted so that dried material is allowed to run through the funnel (3) onto a vibrating sieve. A special device is employed to tap

the inclined frame, to ensure that pouring proceeds smoothly. Both the tilting and tapping of the frames is carried out by mechanisms controlled from behind a wall or an adjacent room.

The funnel (3) through which the dried material is poured onto the sieves is made of graphitized leather, and the sieves of stainless wire are suspended on belts also made of graphitized leather.

The sifted material is poured into a cylindrical vessel of graphitized plastic, approximately 18 cm high and 6 cm in diameter, loosely covered with a lid of soft, black rubber.

The floors in the building are covered with polyvinyl chloride containing graphite or aluminium powder to make them conduct electricity. The air must not be too dry, since this favours the build-up of static charges so it is kept humid by hanging cloth saturated with water on the walls and by moistening the floors from time to time or by using air-conditioning equipment.

Treatment of waste

Waste substances from the manufacture of mercury fulminate are:

- (1) the spent liquor decanted from above the product;
- (2) the sediment removed from the mercury fulminate by washing ("slime");
- (3) condensed vapours.

(1) The spent liquor contains about 3% of dissolved substances, comprising 90–96% of oxalic acid and 3–6% of mercury in the form of mercurous nitrate. The recovery of mercury in the form of mercurous chloride or mercury proper is usually profitable. This is achieved by adding nitric acid to the spent liquor (1 l. of concentrated hydrochloric acid to 50 l. of liquid). The sediment which is precipitated is separated by decantation and dissolved in concentrated hydrochloric acid, using 10 kg of hydrochloric acid for 10 kg of sediment. Next a solution of pieces of tin (1 kg) in hydrochloric acid (6 kg) is added and pure mercurous chloride is precipitated.

Mercury may also be recovered in a metallic form by neutralizing the liquor with milk of lime and dissolving the precipitated sediment in hydrochloric acid, recovering the mercury by electrolysis or by displacement with zinc.

(2) The "slime" is processed in a similar manner, viz. it is dissolved in hydrochloric acid and the mercury recovered from the solution by one of the methods outlined above.

(3) The liquid in the jars and condenser tower may be distilled over sodium hydroxide. The recovered alcohol can be recycled.

(4) Residues of mercury fulminate are destroyed either by dissolving them in sodium thiosulphate or by covering them with quick lime and treating the mixture with live steam.

OTHER SALTS OF FULMINIC ACID

Among other fulminates, the silver salt, $(\text{CNO})_2\text{Ag}$, is of some importance. It is prepared in a way similar to mercury fulminate, by the action of alcohol on a silver solution in nitric acid. Silver fulminate, however, is of little value as an explosive since silver is an expensive raw material. Detonators of silver fulminate were employed only in the Italian Navy.

The other fulminates are of no practical value. They are prepared from mercury fulminate either by reacting the metal amalgam with a suspension of mercury fulminate in water (this is applicable to the majority of metals, including the alkali metals, or simply by the action of the metal itself (e.g. zinc or thallium) which displaces mercury from mercury fulminate (also in water). For example, chips of thallium, zinc, or copper are allowed to stand for some time in a suspension of mercury fulminate in water, the corresponding metal fulminate is gradually formed.

TABLE 24
COMPARISON OF THE PROPERTIES OF FULMINATES

Fulminate	Initiation temperature °C	Sensitiveness to impact, work in kgm/cm ²
Sodium	215	—
Potassium	225	—
Calcium	195	165
Strontium	205	170
Barium	220	175
Cadmium	210	110
Copper(II)	205	110
Manganese	215	150
Thallium	110	40
Silver	170	—

Rosenberg [63] investigated the properties of sodium, potassium, calcium, strontium, barium, cadmium, cupric, copper, manganese, thallium and silver fulminates and compared them with mercury fulminate. Some of this results are shown in Table 24.

TABLE 25

Smallest amount which will cause detonation of	Initiated high explosive		
	Tetryl	Picric acid	TNT
Mercury fulminate	0.29	0.30	0.36
Silver fulminate	0.02	0.05	0.095
Cadmium fulminate	0.08	0.05	0.11
Copper fulminate	0.025	0.08	0.15
Thallium fulminate	0.30	0.43	

Martin [64] examined the initiating properties of certain fulminates, and found that silver, cadmium and copper fulminates have stronger initiating properties than mercury fulminate. Table 25 and Fig. 45 show the figures obtained by Wöhler and Martin [65], expressed as the smallest amounts of the fulminate of different metals necessary to produce detonation of various high explosives.

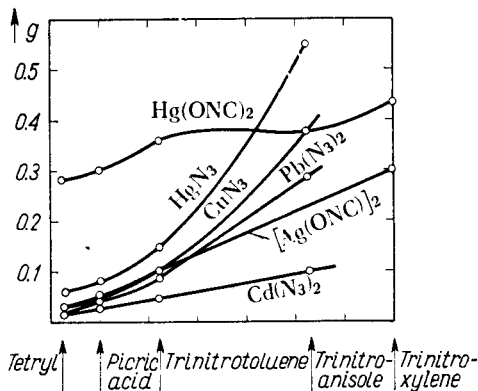
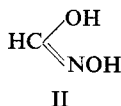
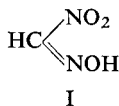

FIG. 45. Initiating ability of various priming explosives, according to Wöhler and Martin [65].

These compounds, however, have not been used in practice (apart from silver fulminate, as mentioned above) due to the high cost of preparing them.

Fulminic acid can be regarded as the simplest oxime. A number of compounds with an oxime group $C=NOH$ can form salts which possess initiating properties, for example salts of nitroformoxime (methylnitrolic acid) (I) which can be obtained in a known way by the action of nitrous acid on nitromethane. Salts of formhydroxamic acid (II), particularly the mercuric salt, also possess initiating properties [66]. Formhydroxamic acid can be obtained by the action of hydroxylamine on formic acid esters or by oxidation of methylamine.



LITERATURE

1. K. SINGH, *J. Chem. Soc.* **1959**, 459.
2. W. BECK, *Chem. Ber.* **95**, 341 (1962).
3. H. WIELAND, *Ann.* **444**, 20 (1925).
4. M. WALKER and D. N. ELDRED, *Ind. Eng. Chem.* **17**, 1074 (1925).
5. L. WÖHLER and I. F. ROTH, *Chem. Ztg.* **50**, 761 (1926).
6. J. LIEBIG, *Ann. Chim.* **2**, 294 (1823).
7. J. U. NEF, *Ann.* **280**, 263, 305 (1894).
8. L. WÖHLER and K. TEODOROWICZ, *Ber.* **38**, 1345 (1905).

9. H. WIELAND, *Ber.* **42**, 821 (1909).
10. A. SOLONINA, *Z. ges. Schiess- u. Sprengstoffw.* **5**, 41, 67 (1910).
11. F. ANGELICO, *Atti reale accad. Linzei, Roma* **10**, 476 (1901).
12. L. W. JONES, *Am. Chem. J.* **20**, 1 (1898).
13. F. D. MILES, *J. Chem. Soc.* **1931**, 2532.
14. H. KAST, *Jahresber. Mil. Vers. Amt.* **13**, 79 (1908).
15. L. WÖHLER and A. BERTHMANN, *Angew. Chem.* **43**, 59 (1930).
16. L. WÖHLER, *Ber.* **38**, 1351 (1905).
17. H. KAST, *Spreng- u. Zündstoffe*, Vieweg & Sohn, Braunschweig, 1921.
18. A. MARSHALL, *Explosives*, Vol. II, Churchill, London, 1917.
19. L. SHISHKOV, *Ann.* **97**, 54 (1856).
20. P. NICOLARDOT and J. BOUDET, *Bull. soc. chim. France* **25**, 119 (1919).
21. M. BERTHELOT and P. VIEILLE, *Compt. rend.* **90**, 946 (1880).
22. M. PATRY, *Combustion et detonation*, Paris, 1933.
23. A. F. HOLLEMAN, *Rec. trav. chim.* **15**, 159 (1896).
24. K. SINGH, *Trans. Faraday Soc.* **52**, 1623 (1956).
25. A. STEINER, *Ber.* **9**, 779 (1876).
26. P. GRIGOROVICH, *Zh. Russ. Khim. Obshch.* **37**, 113 (1906).
27. A. MAJRICH, *Z. ges. Schiess- u. Sprengstoffw.* **31**, 147 (1936).
28. G. TODD and E. PARRY, *Nature* **181**, 260 (1958).
29. A. M. YUILL, Ph. D. Thesis, Cambridge, 1953, according to F. P. BOWDEN and A. D. YOFFE, *Fast Reactions in Solids*, Butterworths, London, 1958.
30. A. F. BELAYEV and N. MATYUSHKO, *Dokl. Akad. Nauk SSSR* **30**, 629 (1941).
31. R. C. FARMER, *J. Chem. Soc.* **121**, 174 (1922).
32. E. CARSTANJEN and A. EHRENBERG, *J. prakt. Chem.* **25**, 232 (1882).
33. R. SCHOLL, *Ber.* **27**, 2916 (1894).
34. A. STEINER, *Ber.* **7**, 1244 (1874); **8**, 518, 1177 (1875).
35. A. LANGHANS, *Z. anal. Chem.* **57**, 401 (1917); *Z. angew. Chem.* **31**, 1, 161 (1918); *Z. ges. Schiess- u. Sprengstoffw.* **13**, 345, 406 (1918); **14**, 300, 399 (1919); **15**, 7, 23, 89, 219 (1920).
36. A. LANGHANS, *Z. anal. Chem.* **60**, 93 (1921); *Z. ges. Schiess- u. Sprengstoffw.* **16**, 105 (1921).
37. H. RATHSBURG, *Ber.* **54**, 3185 (1922).
38. R. WALLBAUM, *Z. ges. Schiess- u. Sprengstoffw.* **34**, 124, 197 (1939).
39. HESS and DIETL, *Mitt. Art.-Gen. Wesen* **18**, 405 (1887).
40. A. LANGHANS, *Z. ges. Schiess- u. Sprengstoffw.* **17**, 9-28, 122-159 (1922).
41. W. E. GARNER and H. R. HAILES, *Proc. Roy. Soc. (London)* **A 139**, 576 (1933).
42. E. G. PROUT and F. C. TOMPKINS, *Trans. Faraday Soc.* **40**, 488 (1944).
43. J. VAUGHAN and L. PHILLIPS, *J. Chem. Soc.* **1949**, 2741.
44. W. E. GARNER and E. W. HAYCOCK, *Proc. Roy. Soc. (London)* **A 211**, 335 (1952).
45. B. E. BARTLETT, F. C. TOMPKINS and D. A. YOUNG, *J. Chem. Soc.* **1956**, 3323.
46. W. E. GARNER, *Science Progr.* **33**, 209 (1938-39).
47. F. P. BOWDEN *et al.*, *Nature* **178**, 409 (1956).
48. P. LAFFITTE and M. PATRY, *Compt. rend.* **193**, 173 (1931).
49. J. I. EVANS and A. M. YUILL, Discussion Roy. Soc., Initiation and Growth of Explosion in Solids, *Proc. Roy. Soc. (London)* **A 246**, 176 (1958).
50. J. BERCHTOLD and J. EGGERT, *Naturwiss.* **40**, 55 (1953).
51. J. EGGERT, *Physik. Bl.* **12**, 549 (1954).
52. J. V. R. KAUFMAN, Discussion Roy. Soc., Initiation and Growth of Explosion in Solids, *Proc. Roy. Soc. (London)* **A 246**, 219 (1958).
53. A. G. GORST, *Porokha i vzryvchatyye veshchestva*, Oborongiz, Moskva, 1957.
54. A. F. BELAYEV and A. E. BELAYEVA, *Dokl. Akad. Nauk SSSR*, **33**, 41 (1941); **52**, 507 (1946); **54**, 1381 (1946).

55. H. KAST and A. HAID, *Angew. Chem.* **37**, 973 (1924).
56. *Jahresber. chem.-techn. Reichsanstalt* **8**, 122 (1929).
57. A. STETTBACHER, *Nitrocellulose* **8**, 3 (1937).
58. R. ROBERTSON, *J. Chem. Soc.* **119**, 1 (1921).
59. CHEVALIER, *J. des connaissances usuelles*, 1836, according to *Dinglers polyt. J.* **61**, 191 (1837).
60. CHANDELON, *Mém. soc. roy. sci. Liège*, 1848, according to *Dinglers polyt. J.* **108**, 21 (1848).
61. M. A. BUDNIKOV, N. A. LEVKOVICH, I. V. BYSTROV, V. F. SIROTINSKII and B. I. SHEKHTER, *Vzrychatyie veshchestva i porokha*, Oborongiz, Moskva, 1955.
62. T. L. DAVIS, *The Chemistry of Powder and Explosives*, J. Wiley, New York, 1943.
63. ROSENBERG, Dissertation, Darmstadt, 1913; *Chem. Ztg.* **37**, 933 (1913).
64. F. MARTIN, *Über Azide und Fulminate*, Darmstadt, 1913.
65. L. WÖHLER and F. MARTIN, *Angew. Chem.* **30**, 33 (1917); *Ber.* **50**, 586 (1917).
66. L. VENNIN, E. BURLOT and H. LÉCORCHÉ, *Les Poudres et Explosifs*, Librairie Polytechnique Béranger, Paris et Liège, 1932.
67. BIOS Final Report No. 1074, The Manufacture of 22 Rimfire Ammunition, Dynamit A.G. at Nürnberg and Stadeln.

CHAPTER III

HYDRAZOIC ACID AND ITS SALTS

HYDRAZOIC ACID

HYDRAZOIC acid is a colourless liquid, of sharp, irritating odour with a boiling point of about 37°C and a freezing point of about -80°C. It is highly poisonous, its toxicity being of the order of that of hydrogen cyanide. Even the earliest investigators (Curtius [1]) reported that the vapours of hydrazoic acid irritate the respiratory tract, particularly the nasal mucosa, and that its aqueous solution burns the skin. Stern [2] describes a serious case of poisoning with hydrazoic acid. According to the studies of Pravdin and Shakhnovskaya [3] and Shakhnovskaya [4], hydrazoic acid interferes with the oxidation-reduction processes in the human body. Concentrations in air within the range 0.0005-0.007 mg/l. evoke marked symptoms of intoxication. The toxic effect may be delayed, symptoms appearing the day following exposure. The salts of hydrazoic acid, e.g. sodium azide, are also highly poisonous.

Hydrazoic acid in liquid form is very dangerous to handle owing to the ease with which it explodes.

Its chemical structure has been the subject of many investigations. At first, it was assumed to possess either a ring structure as an acid radical $-\text{N}_3$ (I) (Curtius [1]), or a chain structure (II) (Thiele [5], Franklin [6]):

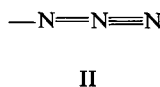
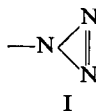

X-Ray investigations of the structure of azides by Hendricks and Pauling [7], and Frevel [8] confirmed Thiele's formula (II) and indicated that the chain structure (III) has the extreme forms a and b:

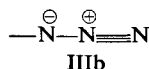
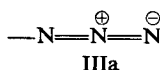

The interatomic distances are equal, amounting on average to 1.15 Å.

The more recent investigations by Llewellyn and Whitmore [9] with strontium azide, for example, have confirmed the above findings. The distances between the atoms of nitrogen are 1.12 Å, and between the furthest atoms of nitrogen in the two N₃ groups and the atom of strontium: 2.63 and 2.77 Å respectively.

Knaggs [10] found that in the case of cyanuric triazide the distance between the pairs of nitrogen atoms is not the same, being 1.26 and 1.11 Å respectively. Examination of the Raman spectrum of sodium azide solutions has confirmed the chain structure of hydrazoic acid (Langseth, Nielsen and Sörensen [11]). The same conclusion is drawn from investigations of the absorption spectrum in the infra-red (Herzberg *et al.* [12]).

For the gaseous state the interatomic distances and angles

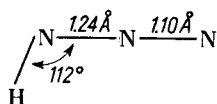

were determined by investigation of the rotational spectrum (Eyster [13]) and the microwave spectrum (Amble and Dailey [14]).

The structure of methyl azide, the simplest organic derivative of hydrazoic acid, is:

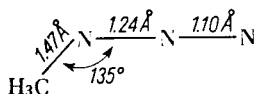

i.e. a characteristic bending of valency bond occurs at the end of the N₃ system.

The structure of the —N₃ group has also been elucidated by Clusius and Weisser [15], by reacting phenylhydrazine with nitrous acid labelled with the heavy isotope ¹⁵N:

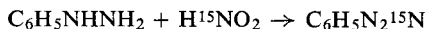

The phenyl azide so obtained was reacted with phenylmagnesium bromide to give diazoaminobenzene, which, in turn, was split into aniline and ammonia. Determination of the isotope content of the reaction products proved that the only linear formula that fits is that in which the extreme nitrogen is the isotope ¹⁵N:

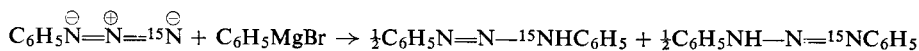

The reduction of both of these compounds would give, in all, 1 mole of aniline, 1 mole of labelled aniline (C₆H₅¹⁵NH₂) and 1 mole of ordinary ammonia. This is in agreement with the results of the experiment.

Apart from compound (I) an insignificant amount of product (II) is formed in which the heavy nitrogen occupies a different position C₆H₅—N=¹⁵N=N.

On the basis of their observations, the authors drew up the following reaction mechanism for the formation of phenyl azide:

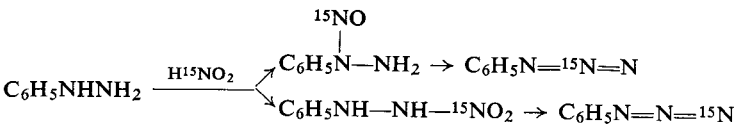

If the group N_3 had a ring structure, the equivalence of the nitrogen atoms (2) and (3)

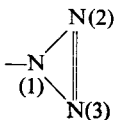

would involve the addition of phenylmagnesium bromide at both positions (2) and (3) with the same probability. The addition products would be the following labelled diazoaminobenzenes:

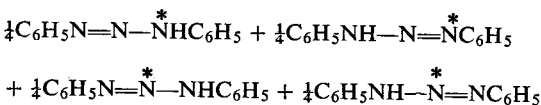

The reduction of these compounds would give $\frac{1}{2}$ mole of labelled aniline, $1\frac{1}{2}$ moles of ordinary aniline, $\frac{1}{2}$ mole of labelled ammonia and $\frac{1}{2}$ mole of ordinary ammonia, which is incompatible with the experimental results actually obtained.

Spectrographic analysis of the derivatives of hydrazoic acid

Electronic spectrum. The N_3 group is a chromophore, and may be classified as a chromophore with two cumulated double bonds (Braude [16])



Such chromophores are characterized by absorption bands of low intensity.

Ethyl azide and azidoacetic acid $\text{N}_3\text{CH}_2\text{COOH}$ may serve as examples of compounds in which N_3 is linked to an organic residue by a covalent bond. In an alcohol solution they show the following bands:

285 $m\mu$ of very low intensity ($E=ca. 20$) and

220 $m\mu$ of higher intensity ($E=ca. 150$) (V. Henri [17], W. Kuhn and Braun [18], Mohler [19], Sheinker [20]).

Sheinker and Syrkin [21] discovered a difference between the absorption spectrum of the ion N_3^\ominus in inorganic and organic azides (salts). They concluded that the transition from the azide ion to the azide linked with alkyl group by a covalent bond involves a change in the symmetry of the N_3 group due to the change in length of the bonds $\text{N} - \text{N}$.

According to Jacobs and Tompkins [22] in the reflection spectrum sodium azide and barium azide give a band with the maximum in the vicinity of 240 $m\mu$ and 202 $m\mu$ respectively. Evans and Yoffe [23] found a value of 248 $m\mu$ for potassium

azide. Tompkins and Young [24] established that potassium azide gives new absorption bands on irradiation in the ultra-violet at a low temperature (-196°C).

For other azides (in the solid state) the following bands were found in the reflection spectrum:

TABLE 26

Azide	Bands max.	Temperature	Author
TiN_3	275 $\text{m}\mu$	room temperature	Evans, Yoffe [23]
	320 $\text{m}\mu$	room temperature	Evans, Yoffe [23]
	425 $\text{m}\mu$	room temperature	Evans, Yoffe [23]
AgN_3	359 $\text{m}\mu$	-175°C	McLaren, Rogers [25]
$\text{Hg}_2(\text{N}_3)_2$	390 $\text{m}\mu$	room temperature	Deb, Yoffe [26]
$\text{Pb}(\text{N}_3)_2$	400 $\text{m}\mu$	room temperature	McLaren [27]

Infra-red spectrum. The spectrum of hydrazoic acid has been examined by a number of authors. Thus, two bands were found by Eyster [28]:

2141 cm^{-1} asymmetric stretching vibrations and
1269 cm^{-1} symmetric stretching vibrations.

Dows and Pimentel [29] present the following table for the frequencies of vibrations of HN_3 and DN_3

TABLE 27

Approximate description	Frequency, cm^{-1}	
	HN_3	DN_3
H—N stretching	3336	2480
N—N—N asymmetric stretching	2140	2141
N—N—N symmetric stretching	1274	1183
H—N—N bending	1150	955
N—N—N bending	672	638
N—N—N bending	522	498

The asymmetric and symmetric vibrations of methyl azide have frequencies of 2141 cm^{-1} and 1351 cm^{-1} respectively (Eyster and Gillette [30]). For a number of aliphatic and aromatic azides Lieber *et al.* [31] found the figures 2114–2083 cm^{-1} for asymmetric vibrations and 1297–1256 cm^{-1} for symmetric ones. Among the other authors who have examined organic azides the investigations of Boyer [32] and Evans and Yoffe [33] are noteworthy.

The most extensive investigations of the infra-red and Raman spectra of metal azides were made by Gray and Waddington [34]. The Raman spectrum of azides was studied by: Kahovec *et al.* [35], Kohlrausch and Wagner [36], and Sheinker and Syrkin [21].

The results of the investigations of Gray and Waddington are tabulated below.

TABLE 28
FUNDAMENTAL VIBRATION FREQUENCIES OF N_3 ION
(GRAY AND WADDINGTON [34])

Salt	Frequencies, cm^{-1}			
	Raman		Infra-red	
LiN_3	1369	1277	2092	635
NaN_3	1358	1267	2128	639
KN_3	1344	1273	2041	645
RbN_3	1339	1271	2024	642
CsN_3	1329	1267	2062	635
$Ca(N_3)_2$	1380.5	1267	2114	638
$Sr(N_3)_2$	1373	1273	2096	635
$Ba(N_3)_2$	1354	1278	2123	650
			2083	637
NH_4N_3	1345	—	2041	661
				650

The infra-red spectra of the heavy metal azides, which are the most interesting because of their explosive properties, were investigated by Garner and Gomm [37], Lecomte *et al.* [38], and the Raman spectra have been studied by Kohlrausch and Wagner [36], and by Deb and Yoffe [26]. The results are given in Table 29.

TABLE 29

Salt	Frequencies, cm^{-1}				Author
	Raman		Infra-red		
TlN_3			1941	636	Lecomte <i>et al.</i> [38]
AgN_3			2173	644	Lecomte <i>et al.</i> [38]
				680	Lecomte <i>et al.</i> [38]
CuN_3	1337		2110	615	Deb and Yoffe [26]
		1268		642	Lecomte <i>et al.</i> [38]
$Hg_2(N_3)_2$	1300		2080	1322, 1273, } 647, 592 } 675, 644, 642 } 584 }	Deb and Yoffe [26]
$Hg(N_3)_2$	1313		2070	630	Deb and Yoffe [26]
$Pb(N_3)_2$	1352			630	Lecomte <i>et al.</i> [38]
	1350	1254	2006	628	Kohlrausch <i>et al.</i> [35, 36]
			2080		Garner and Gomm [37]
	1352		2040		

Summing up the infra-red and Raman spectra data of various authors, Bellamy [39] quotes the following frequencies:

for asymmetric vibrations 2160–2120 cm^{-1}
for symmetric vibrations 1340–1180 cm^{-1}

The first of these bands has a frequency very similar to that of a diazo group and of the C=N group in isocyanates and other compounds.

Hydrazoic acid is a weak acid like acetic acid. Mendelejev [40] noted its acidic properties. It reacts with zinc, iron, magnesium and aluminium, to form azides with evolution of hydrogen (Curtius and Rissom [41]; Curtius and Darapsky [42]). A small amount of ammonia is also produced, due to the reduction of hydrazoic acid. According to Sofianopoulos [43] heated Al dust reacts with HN_3 to form aluminium nitride

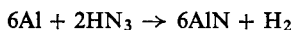

Hydrazoic acid also reacts with copper, silver and mercury but in a different way: it forms azides without loss of hydrogen and a considerable amount of hydrazoic acid is reduced to ammonia or hydrazine and free nitrogen. The reaction with copper recalls the action of nitric acid on this metal.

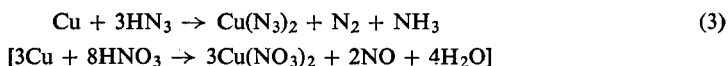

Hydrazoic acid, like nitric acid, oxidizes hydrogen sulphide to form sulphur:

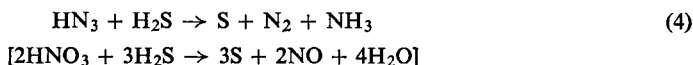

When mixed with hydrochloric acid it forms a solution resembling that of nitrohydrochloric acid in its properties and capable of dissolving noble metals, e.g. platinum:

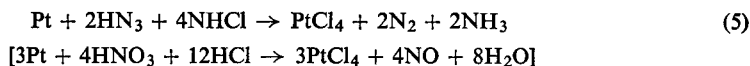

Hydrazoic acid reacts with potassium permanganate. They mutually reduce each other to evolve a mixture of nitrogen and oxygen. Nitrous acid oxidizes hydrazoic acid with the evolution of nitrogen.

Hydrazoic acid and its salts give a deep red colour with ferric chloride resembling that of ferric chloride with the salts of thiocyanic acid. This colour fades under the influence of hydrochloric acid.

Liquid hydrazoic acid explodes on heating to 100°C in a tube (Dennis and Isham [44]). According to R. Meyer and Schumacher [45] an explosion may also occur either on rapid cooling, on filtering the liquid acid under vacuum or by passing compressed oxygen into a vessel containing liquid hydrazoic acid. These authors examined the decomposition of gaseous hydrazoic acid at temperatures ranging from 306 to 330°C under pressures between 30 and 200 mm Hg. Decomposition proceeds quantitatively according to the equation



The reaction is monomolecular. The half-life at 330°C is 12 min. In a dilute aqueous solution hydrazoic acid is stable and not liable to decompose even on long boiling (Curtius [46]). However, a 17% aqueous solution of hydrogen azide can probably detonate [47].

Gaseous hydrazoic acid is liable to non-explosive decomposition at a temperature above 250°C. At 33°C the half-life is 12 min.

Hydrazoic acid is decomposed by ultra-violet radiation. In all probability the decomposition proceeds gradually with the formation of free radicals (Beckman and Dickinson [48]):

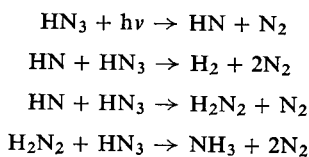

According to Stewart [49] hydrazoic acid decomposes under the influence of active nitrogen to form the NH radical.

A number of investigations have been devoted to the thermal decomposition of hydrazoic acid or to decomposition produced by electric discharge. Thus Rice and Freamo [50] established that its thermal decomposition at 77°K leads to the formation of a blue-coloured sediment. At a higher temperature, 148°K, it changes colour, forming a white substance which has been identified as ammonium azide. They suggested that the blue colour is caused by the presence of the free imino radical NH.

Mador and Williams [51] and Dows, Pimentel and Whittle [52] continued investigations on the subject. According to the former the blue substance contains the radicals NH and NH₂ while the latter believe that the radicals NH and (NH)_x are present. Spectrographic analysis by Pannetier and Gaydon [53] has confirmed the presence of the electronically excited NH radical.

Using Norrish's "flash photolysis method" [54], Thrush [55] examined the decomposition of hydrogen azide in the presence of an excess of inert gas. The absorption spectra characteristic of the radicals NH and NH₂ were observed. He therefore suggested an alternative scheme for the decomposition of hydrazoic acid, different from that proposed by Beckmann and Dickinson [56]:

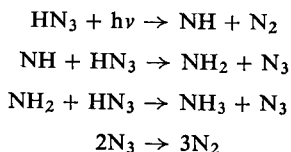

He also observed an absorption band at 2700 Å which he attributed to the N₃ radical. According to Gray and Waddington [57] the initial step in the decomposition of HN₃ is nearly thermoneutral:



Becker, Pimentel and Van Thiel's [58] equally interesting study of the photolysis of solid hydrazoic acid led to the assumption that the radicals NH, NH₂ and N₃ are formed during decomposition.

Franklin, Herron, Bradt and Dibeler [59] studied the decomposition of hydrazoic acid under a reduced pressure, on ignition by means of Tesla discharges. The reaction

products included hydrogen, nitrogen, ammonia and undecomposed hydrazoic acid. Similar results were obtained by Foner and Hudson [60].

Irradiation of an aqueous solution of HN_3 leads to the formation of hydroxylamine according to the reaction.



According to Alekseyev [62] explosion of a mixture of HN_3 and hydrogen gives ammonium azide and the intermediate compound $\text{N}_2\text{H}_5\text{N}_3$.

The salts of hydrazoic acid, the azides, have solubilities similar to those of the corresponding chlorides. Sodium azide dissolves in water. Silver azide does not dissolve in water or in nitric acid, but dissolves easily in an aqueous solution of ammonia. Lead azide, like lead chloride, is sparingly soluble in cold water but more soluble in hot water; it is also soluble in ammonium acetate.

There are two methods for the manufacture of hydrazoic acid or its salts. One is derived from a number of investigations by Curtius [1] and is based on the action of nitrous acid on hydrazine:

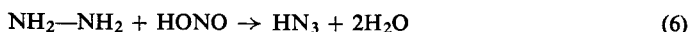

An excess of nitrous acid decomposes hydrazoic acid in accordance with the equation:

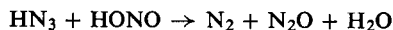

(Seel and Schwaebel [63], G. Stedman [64]).

The reaction is quantitative and is used in practice for destroying waste azides.

Reaction (6) is particularly well suited for use in the preparation of the organic derivatives of hydrazoic acid from the corresponding derivatives of hydrazine. Nitrous esters may be employed, instead of the acid, e.g. ethyl nitrite in the presence of sodium hydroxide

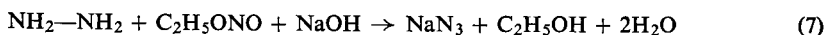

This method is preferable to reaction (6) since the sodium salt is formed instead of the volatile and highly toxic hydrazoic acid.

The other widely used method, that of Wislicenus [65], is based on the action of nitrous oxide on sodium amide. The reaction takes place in the following sequence:

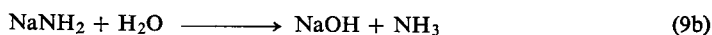
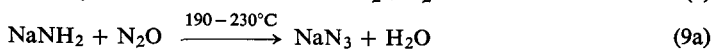
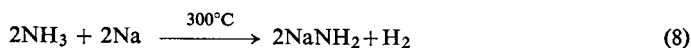

Reactions (9a) and (9b) proceed concurrently: nitrous oxide first reacts with molten sodium amide to form sodium azide and water vapour. The latter then reacts with another molecule of sodium azide, hydrolysing it with the formation of sodium hydroxide and ammonium (9b).

The mechanism of reaction (9a) has been examined by isotope techniques using nitrous oxide labelled with ^{15}N (Clusius *et al.* [66, 67]). The course of the reaction

may be summarized by the equations:

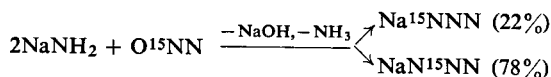

Among other reactions leading to the production of hydrazoic acid, the following are noteworthy for theoretical reasons:

The formation of hydrazoic acid and its derivatives together with ammonia from diazo compounds under the influence of hydrazine or its derivatives was explained by Thiele [68]. At an intermediate stage a diazohydrazine, e.g. $\text{C}_6\text{H}_5\text{N}_2\text{NHNH}_2$, is formed which then undergoes decomposition according to two parallel reactions:

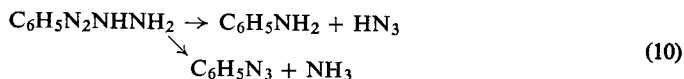

Hydrazoic acid may be formed from hydrazine under the influence of oxidizing agents. This was first noticed by Sabaneyev [69] who acted hydrazine with nitric acid. According to Jannasch and Jahn [70] chlorates act similarly in an acidic medium while Turrentine and Olin [71] found that hydrazine can be oxidized by electrolysis to hydrazoic acid. On the other hand, according to Tanatar [72] a number of other oxidizing agents such as chromic acid, permanganates, and hydrogen peroxide give hydrazoic acid only in the presence of hydroxylamine. The reaction probably occurs in the following way:

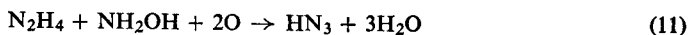

The preparation of inorganic azides was reviewed by Audrieth [73] and more recently by Evans, Yoffe and Gray [74].

LEAD AZIDE

Neutral azide

Apart from mercury fulminate, lead azide is the most important primary explosive.

Lead azide can exist in two allotropic forms: the α -form is orthorhombic, the β -form monoclinic. (Miles [75], Garner and Gomm [37]). The crystallographically stable modification is the α -form. It is prepared by rapidly stirring a solution of sodium azide with a solution of lead acetate or lead nitrate.

The β -form is prepared by slow diffusion of sodium azide and lead nitrate solutions. This form has a tendency to revert to the α -form, either on standing at an elevated temperature (*ca.* 160°C), or when crystals of the β -form are kept in water containing a crystal of the α -form (Azároff [76]) or on contact with a lead salt solution (Miles [75]).

The properties of both those forms, as reported by Gray and Waddington [77], together with new figures for the density, are tabulated below.

TABLE 30

Species	Density	Unit cell size			No. of molecules in unit cell	Heat of formation $-\Delta H_f$ kcal/mole
		<i>a</i>	<i>b</i>	<i>c</i>		
orthorhombic	4.71	6.628	11.312	16.256	12	115.5
monoclinic	4.93	5.090	8.844	17.508	8	115.8

The apparent density of the α -form is 1.2.

The earlier opinion that the β -form is the more sensitive to impact appears to be incorrect. This problem will be discussed more fully in the section on the explosive properties of lead azide.

Lead azide is insoluble in an aqueous solution of ammonia. Acetic acid causes its decomposition but it is soluble in water and concentrated solutions of sodium nitrate, sodium acetate or ammonium acetate. There are fairly big differences of solubility, depending on temperature.

Solonina [78] quotes the following figures for the solubility of lead azide:

in 100 ml of water	at 18°C	0.023 g
	at 70°C	0.090 g
in 100 ml of concentrated solution of NaNO ₃	at 18°C	0.125 g
	at 80°C	0.487 g
in 100 ml of concentrated solution of CH ₃ COONa	at 18°C	1.542 g
	at 80°C	2.020 g

Owing to the difference between its solubility in the cold and in the hot, lead azide may be recrystallized from water or from the solutions mentioned above. Under these conditions the crystals are obtained in the form of long, colourless needles.

Majrich [79] reports that lead azide dissolves in ethanalamine, but it is not practicable to precipitate a pure form, suitable for commercial use by dilution of this solution.

According to Wöhler and Krupko's [80] data, recrystallization of lead azide from water or from aqueous solutions is not free from hazard, since the salt often explodes during crystallization. For this reason lead azide is not recrystallized in practice. The phenomenon will be discussed later on p. 173.

The specific heat of lead azide, as reported by Yuill [81], is:

at 100°C	0.100 cal/g
at 200°C	0.117 cal/g
at 250°C	0.116 cal/g

McLaren [82] determined the thermal conductivity of pressed pellets of azides and obtained a value of 4×10^{-4} (c.g.s. units) at 45°C, the density of the pellets being 3.62 g/cm³.

The V.D.H. hardness values of the crystals, according to Yuill [81] are

for α -lead azide: 114 kg/mm² at a load of 50 g
 103 kg/mm² at a load of 20 g
 for β -lead azide: 65 kg/mm² at a load of 5 g

Todd and Parry [83] quote figures for the α -form which prove that lead azide is much harder than mercury fulminate.

Lead azide, like hydrazoic acid, is liable to undergo oxidation and reduction reactions. It is partially decomposed by atmospheric oxygen to form free hydrazoic acid, nitrogen and ammonia. This reaction is promoted by the presence of carbon dioxide in the air. When boiled in water, lead azide undergoes slow decomposition with the evolution of hydrazoic acid.

Lead azide is completely decomposed by the action of dilute nitric or acetic acid in which sodium nitrite has been dissolved, and the products pass to the solution. This reaction may be used for the destruction of lead azide wastes and residues, using 15% nitric acid and 8% sodium nitrite.

In an aqueous suspension, lead azide is oxidized by ceric sulphate to form nitrogen:

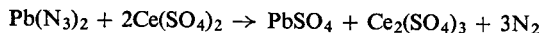

This reaction may be employed for the quantitative determination of azide.

Long experience in the storage of blasting caps filled with lead azide has shown that this substance reacts with copper or brass to form cupric azide, which is highly sensitive to friction and impact. For this reason lead azide is compressed only into aluminium and zinc cases.

When exposed to light lead azide soon turns yellow on the irradiated side. The layer of changed substance protects the deeper layers from further decomposition and thus irradiation does not entail changes in the explosive properties of the substance. However, as Wöhler and Krupko [80] have shown, if the lead azide is subjected to stirring during irradiation, decomposition may proceed too far.

Slow decomposition of lead azide takes place under the influence of ultra-violet irradiation, as demonstrated by the investigations of Garner and Maggs [84] and Tompkins *et al.* [22, 85], but if the irradiation is very intense, explosion may occur, as was shown by Berchtold and Eggert [86] and Meerkamper [87]. In another paper Eggert [88] reported that the light intensity required to cause the explosion of lead azide is 2.0 J/cm² when the electrical energy of the flash is 240 J, and the half-life of the flash 0.8 msec.

As shown by the investigations of a number of authors, irradiation of lead azide (and other azides) with α -particles, X-rays and γ -rays does not cause explosion (Haïssinsky and Walden [89]; Günther, Lepin and Andreyev [90]). However, it produces a slow decomposition of lead azide, according to Kaufman [91].

Grocock [92] noticed that lead azide irradiated with γ -rays at an elevated temperature decomposed more rapidly than that which has not been irradiated.

The thermal stability of lead azide is very high. At 75°C it loses approximately 0.8% of its weight during the first 4 days, after which further heating involves a loss of 0.03–0.05% per week (Wallbaum [93] cf. graph in Fig. 30). At 115°C, in the dark, it undergoes no changes for 24 hr unless the temperature reaches 170°C when a distinct loss of weight takes place during that time. At temperatures above 200°C decomposition is quite rapid, ranging from a few hours to several minutes, depending on the temperature, and the substance loses its explosive properties. On the other hand, in the light, decomposition may be observed even at 50°C.

Bowden and Singh [94] and later Bowden and McAuslan [95] using the electron microscope, observed that on heating at a temperature above 120°C the separate crystals of lead azide (like those of cadmium or silver azides), break down into fine particles, approximately 10^{-5} cm in dia. and decomposition reaction takes place chiefly on the newly-formed surfaces. This makes it evident that the thermal decomposition of azides cannot be regarded as a surface reaction or a process occurring within large crystals only; the whole mass is involved, due to crystal breakdown.

According to various authors, the ignition temperature of lead azide ranges from 327 to 360°C. When a test sample is dropped onto a metal plate instant explosion ensues if the temperature of the plate is 380°C or higher. The ignition temperature of lead azide is the highest ignition temperature of an explosive ever to have been observed.

According to Sudo [96] lead azide prepared by the action of sodium azide on an aqueous solution of lead acetate has a lower ignition temperature (332–336°C) than that obtained by the action on a solution of lead nitrate (339–359°C).

According to Garner and Gomm [37] the activation energy of the thermal decomposition of lead azide is 38.0 kcal/mole, assuming that the reaction can be expressed by an equation of the form $p = kt$.

Evans and Yuill [97] investigated the ignition of dextrinated lead azide by the adiabatic compression of air surrounding it, and estimated that the 50% explosion level corresponds to a temperature of 990°C.

Bryan and Noonan [98] carried out similar investigations using helium and estimated the minimum energy required to ignite lead azide with a 3 msec delay to be 0.087 cal/cm², i.e. less than that for blasting gelatine, 0.15 cal/cm², PETN, 0.25 cal/cm² and tetryl, 0.33 cal/cm².

Lead azide detonates with a high rate, amounting to 4500 m/sec at a density of 3.8 and 5300 m/sec at a density of 4.6 (Kast and Haid [99]).

According to the Chemisch Technische Reichsanstalt [100] the rate of detonation of lead azide at a density of 2.75 is 3620 m/sec and at a density of 3.65—4700 m/sec.

The rate of detonation of a thin film of lead azide (0.1–0.5 mm thick) is 2100 m/sec (Bowden and Williams [101]). Lead azide is less sensitive to impact than mercury fulminate, but drop test figures quoted by various authors differ widely. Some of them report a negligible difference between the two, while others state it is considerable (e.g. that azide requires 2–3 times the height of drop necessary to explode fulminate). On the other hand, when mixed with pulverized sand lead azide is more

sensitive than mercury fulminate, which makes it evident that lead azide is more sensitive to friction than fulminate. Its high sensitiveness to friction has been confirmed by a number of accidents. Nevertheless, lead azide does not necessarily explode when rubbed in a porcelain mortar. On the other hand, numerous cases of spontaneous explosion of lead azide are known, e.g. during pouring, weighing, drying and even when simply left standing or left for crystallizing. It was formerly believed

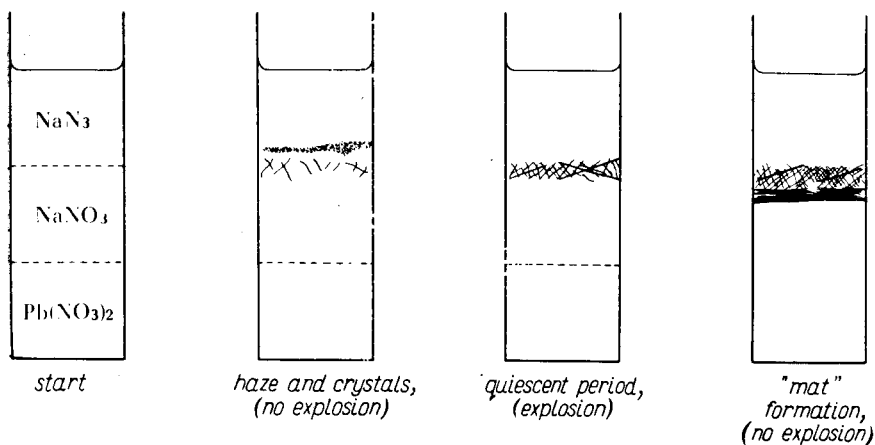

FIG. 46. The diffusion growth of β -lead azide [103].

that the β -form is particularly liable to explosion when crystallized in the form of long needles. Hawkes and Winkler [102], however, prepared crystals of the β -form 3–4 mm long which did not explode on being crushed or broken.

As stated above, Wöhler and Krupko [80] noticed that lead azide may explode during crystallization. Miles [75] confirmed this and stated that spontaneous explosion could occur during the growth period of crystals of β -lead azide, i.e. when the two solutions forming the crystals diffused slowly. When isolated, however, the crystals (some of which had reached a length of 4 cm) were not found to be particularly sensitive.

Rogers and Harrison [103] tried to determine the conditions governing this phenomenon, i.e. the explosion during the growth of β -lead azide. Their experiments, which are illustrated diagrammatically in Fig. 46, were carried out in a test-tube. Three solutions were carefully introduced so that they did not mix. The bottom layer consisted of 20% lead nitrate (2 cm³). The middle layer was 20% sodium nitrate (1 cm³). The top layer was 10% sodium azide (2 cm³). Crystals of lead azide formed in the sodium nitrate layer after $\frac{1}{4}$ – $\frac{1}{2}$ hr. They appeared to start from the walls and spread inwards. A major explosion generally occurred in the system after the crystals had been growing for 6–12 hr. A series of very small explosions accompanied by “clicks” sometimes preceded the major explosion.

Explosion occurred under a number of conditions. For example, if a solution was made up by mixing 5% lead nitrate (0.3 cm³), 2% sodium azide (0.3 cm³) and

water (2 cm^3) no immediate precipitate was formed. Crystals appeared after *ca.* $\frac{1}{2}$ hr, and spontaneous explosions occurred in certain cases. In all the experiments where crystals exploded the common feature was that the initial concentration of azide in the solution around the crystals was only slightly above the saturation

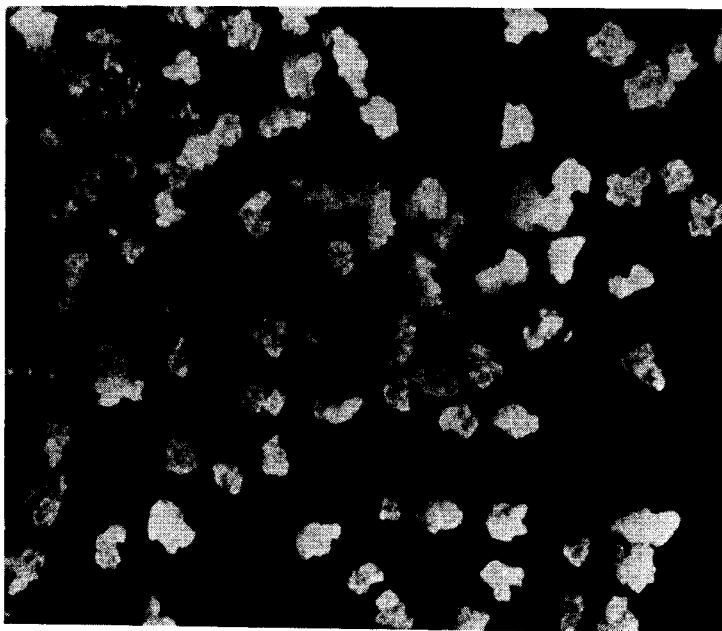

FIG. 47. Lead azide for use in detonators ($75\times$) precipitated in the presence of dextrin according to Davis [104].

value. No explosions were observed when the azide was precipitated rapidly, using very much stronger solutions. A small rise in temperature e.g. of 10°C appears to increase the probability of explosion.

Spontaneous explosions of lead azide also take place during crystallization from saturated solution in ammonium acetate. A detailed study of this phenomenon has been made by Taylor and A. T. Thomas [105]. When the concentration of the solutions and the temperature and conditions of cooling were carefully controlled, they were able to predict the time at which spontaneous explosions occur. E.g.:

with a 1% lead azide solution in 5% ammonium acetate the explosion may be obtained after 40–45 min,

FIG. 48. Lead azide precipitated in different conditions, according to Sudo [96]: (a)—from high concentration of lead acetate (10%) and low of sodium azide (4%); (b)—from low concentration of lead acetate (4%) and high of sodium azide (10%); (c)—from low concentrations of lead acetate (4%) and sodium azide (2%); (d)—from high concentrations of lead acetate (25%) and sodium azide (10%) in the presence of gelatine (5%); (e)—from high concentrations of lead nitrate (25%) and sodium azide (10%) in the presence of gelatine (5%) (very small crystal form).

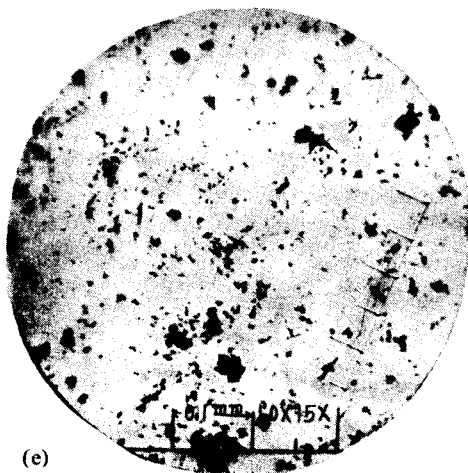
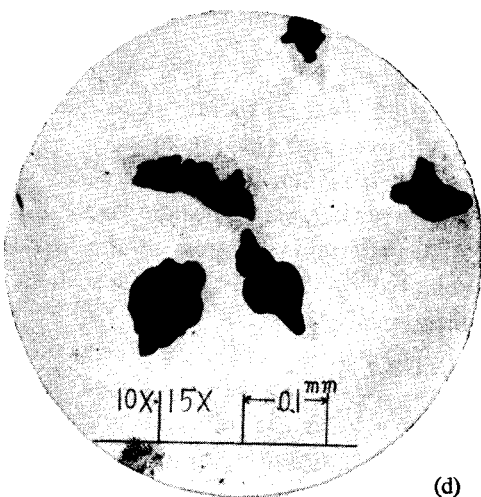
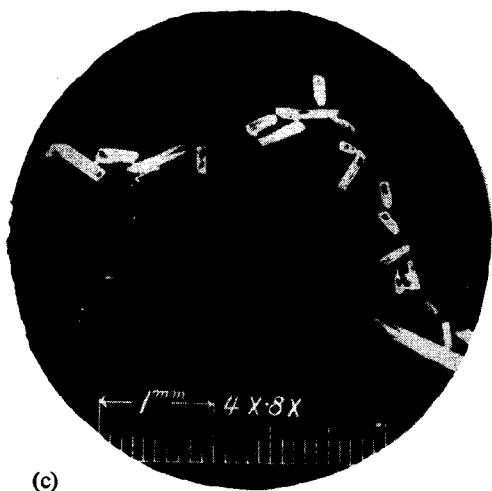
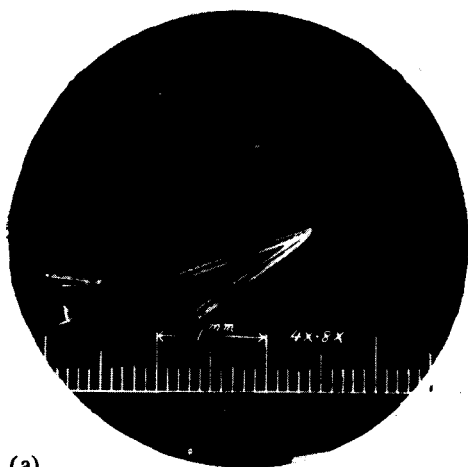

with a 0.6% and 0.5% lead azide solution, the time is 225–255 min and *ca.* 480 min respectively.

Taylor and Thomas have shown that spontaneous explosions are not associated with the large crystals of lead azide that are formed: they filtered off large crystals *ca.* 30 min before the predicted time of explosion and at the predicted time the mother liquor exploded while the filtered lead azide crystals remained intact.

They also found that by adding small amounts of dextrin, polyvinyl alcohol or other hydrophilic polymers explosion could be prevented. It is known that these compounds are able to alter the crystal habit of several substances, including lead azide.

Clearly, explosion is associated with the very early stages of crystallization.

According to Kaufman [91] spontaneous explosion can also take place during the growth of α -lead azide crystals, e.g. when a supersaturated solution of lead azide in ammonium acetate is seeded with crystals of the α -form. Spontaneous explosions have also been observed with mercuric azide and in some cases with cadmium azide.

According to Sudo [96] spontaneous explosion can occur during the formation of lead azide from sodium azide and lead acetate, when the concentration of reacting solutions is high (10% or more).

When manufacturing lead azide, efforts should be made to precipitate small, highly regular, free flowing crystals of a length not exceeding 0.1 mm.

Considerable progress in the manufacture and application of lead azide was achieved by the addition of dextrin to the solution in which it was produced, as mentioned above.

The presence of dextrin in the solution favours the precipitation of tiny, equal sized, rounded crystals. In Fig. 47 magnified crystals of dextrinated lead azide are shown and in Fig. 48 crystals of ordinary lead azide are shown for comparison. According to Sudo [96] gelatine exerts an influence similar to that of dextrin. In this author's opinion when precipitated from a solution containing gelatine lead azide is less sensitive to friction than that from solutions without added colloids.

The sensitiveness of moist lead azide is not much lower than that of the dry product. According to Wöhler and Krupko [80] a 30% water content does not render the lead azide insensitive.

Yuill [81] investigated the sensitiveness of lead azide to impact at room temperature and at -190°C . He found that 10–15% more energy is required for the initiation of explosion by impact at a low temperature than that at room temperature (Table 31).

The disadvantage of lead azide lies in the difficulty with which it is ignited by a flame. For this reason it is usually mixed with lead styphnate i.e. a substance particularly easy to ignite, or the charge of lead azide in a detonator is covered with a layer of lead styphnate. Such a layer not only facilitates the ignition of the lead azide, but also protects it against the action of carbon dioxide. It is also difficult to ignite lead azide by an electric spark (Brown, Kusler, Gibson [106]).

TABLE 31

INITIATION OF EXPLOSION OF LEAD AZIDE PELLETS BY IMPACT

Weight of pellets mg	Specific energy cal/g		Energy difference cal/g
	20°C	-190°C	
0.35	119	134	15
0.42	104	117	13
0.51	93	107	14

Lead azide passes very rapidly from burning to detonation. When used in very small amounts, it is therefore capable of initiating detonation in other explosives, hence it is very suitable for use in detonators though it cannot be employed in caps.

Wallbaum [93] determined the minimum charges of several primary explosives necessary for initiating the explosion of a 0.4 g charge of PETN, loosely poured or pressed. His results are tabulated below.

It is characteristic of lead azide that even under a pressure as high as 2000 kg/cm² it cannot be "dead pressed". This is a great advantage. In practice a pressure of 500-600 kg/cm² is used.

Other data concerning the initiating properties of lead azide, as compared with the other primary explosives, are given in Table 32.

TABLE 32

INITIATION EFFECTS OF PRIMARY EXPLOSIVES

Pressure on PETN, kg/cm ²	0	2000	2000	2000	2000
Pressure on initiator, kg/cm ²	0	0	500	1000	2000
Primary Explosive	Minimum initiating charge, g				
Lead azide (technical)	0.040	0.170	0.050	0.050	0.040
Lead azide (crystallized)	0.015	0.100	0.010	0.010	0.010
Silver azide	0.005	0.110	0.005	0.005	0.005
Mercury fulminate	0.300	0.330		dead pressed	
Tetrazene	0.160	0.250		dead pressed	
Lead styphnate	0.550	1.000		no detonation	

According to Garner [107] lead azide decomposes in the following way:

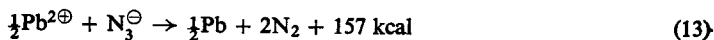
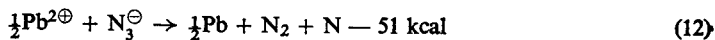

According to the equation (12) one atom of nitrogen is expelled from the N₃[⊖] ion to form two molecules of nitrogen by reaction with another N₃[⊖] ion. Reaction (13) is highly exothermic hence the decomposition of one N₃ group may involve that of

2-3 neighbouring N_3 groups. If these groups decompose simultaneously, the decomposition of 22 ions N_3^\ominus may ensue etc. Thus, the rapid transition of lead azide to detonation may be accounted for by the fact that the decomposition of a small number of molecules of lead azide may induce explosion in a sufficiently large number of N_3^\ominus ions to cause the explosion of the whole mass.

The decomposition of other salts of hydrazoic acid takes a similar course.

Basic azides

Hydrolysis of lead azide with water or a solution of sodium hydroxide yields basic salts. They are also formed by the treatment of a lead salt solution with sodium azide plus sodium hydroxide solution.

Feitknecht and Sahli [108] found five different basic salts, each of which exists in several crystalline modifications as established by X-ray analysis:

I $Pb(N_3)_2 \cdot PbO$	(3 crystalline modifications)
II $3Pb(N_3)_2 \cdot 5PbO$	(3 crystalline modifications)
III $2Pb(N_3)_2 \cdot 5PbO$	
IV $2Pb(N_3)_2 \cdot 7H_2O$	
V $Pb(N_3)_2 \cdot n PbO$, where $n = \text{from 4 to 9.}$	

LEAD AZIDE MANUFACTURE

Lead azide is manufactured on a technical scale by the action of sodium azide on an aqueous solution of lead nitrate. According to a description of manufacture in the Wolfratshausen factory in Germany [109], the reaction is conducted in an open reactor of stainless steel, provided with a jacket warmed by hot water and a stirrer which may be lifted out of the reactor (Fig. 49). The reactor is emptied by tilting. Its upper edge is therefore fitted with a spout so that the contents pour easily. The size of the reactor is such that 4.5 kg of lead nitrate in the form of a 9-10% solution can be used in each batch. This solution is poured into the reactor, warmed to 50°C and neutralized with sodium hydroxide to a pH of about 4.0 (in the presence of methyl orange) and 150 g of dextrin mixed with a small amount of water, is added. The suspension or solution of dextrin in water should be decanted before use to separate mechanical impurities, such as sand.

Next, 1.5 kg of sodium azide is added as a 2.7-3.0% aqueous solution. The solution should be alkaline (50 cm³ of solution should require 8-10 cm³ 1.0 N H₂SO₄ for neutralization using phenolphthalein as indicator). If the alkalinity is too low, a calculated amount of NaOH should be added to the solution. The above-mentioned quantity of sodium azide is poured into the reactor for 1 hr, maintaining a temperature of 50°C.

After the two solutions have been mixed, stirring is stopped. The lead azide so produced should be allowed to settle after which the liquid above is decanted

and the solid is conveyed by a water stream to a cloth filter, stretched on a frame. The azide is washed on the filter with a large amount of water, and then the filter loaded with azide is placed in a bakelite vessel and transferred to the storehouse.

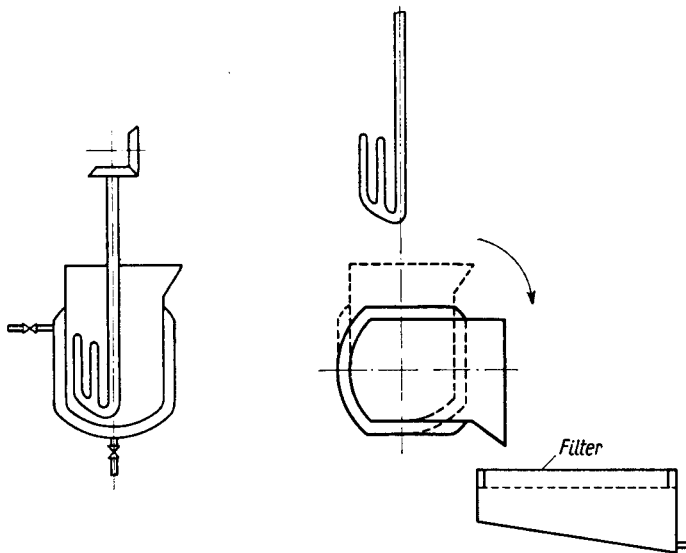

FIG. 49. Diagram of the design and operation of a reactor for the manufacture of lead azide and other primary explosives (tetrazene, lead styphnate and lead picrate).

Drying and sieving is carried out as described in the chapter on mercury fulminate. About 1.2 kg of material is dried at a time on the frame, at a temperature of 65–70°C.

The destruction of azide residues in solutions or suspensions is a matter of great technical importance.

For this purpose the reaction of hydrazoic acid with nitrous acid is utilized (p. 168).

THE CONTINUOUS METHOD OF LEAD AZIDE MANUFACTURE (ACCORDING TO MEISSNER [110, 111])

The method involves introducing a continuous supply of lead nitrate and sodium azide solutions in equivalent proportions into the upper part of the reaction column (Fig. 50) from the bottom of which a suspension of lead azide is removed. The reaction mixture flows down in countercurrent to air blown in.

Lead azide with a purity under 95%

Precipitation. In a dissolving vessel a solution of sodium azide is prepared in distilled water and then aqueous sodium hydroxide is added. The quantity of sodium hydroxide used depends on the amount of lead azide to be produced. The solution

thus prepared is conveyed, via a filter, into a receiver standing in the upper floor. Here, it is heated up to the reaction temperature. (According to some information [112] the optimum temperature is $36 \pm 1^\circ\text{C}$. Too high a temperature may cause the precipitation of irregular, small crystals.) In another dissolving vessel a solution

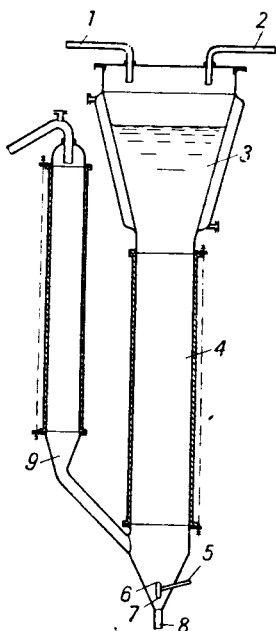

FIG. 50. Column for continuous manufacture of heavy metal azides and lead styphnate, according to Meissner [110]: 1,2—*inflow of reacting solutions*, 3,4—*reaction column*, 5—*air nozzle with exit openings*, 6 and 7 directed up- and downwards, respectively, 8—*outlet*, 9—*overflow*.

of lead nitrate in distilled water is prepared. The solution is filtered and transferred into the receiver. The appropriate amount of dextrin dissolved in water is also added, and the solution is heated up to the reaction temperature. Before the precipitation reaction is begun the precipitation column should be filled with warm distilled water at the desired precipitation temperature, and the air agitation must be switched on. Then the flowmeters for feeding the lead nitrate solution and the sodium azide solutions are opened in turn. After some minutes, the clip of the drain hose is adjusted in such a way that the liquid level in the precipitation column remains at the same height, i.e., the amount of mother liquor discharged with the crystals equals that of the solutions run in. The liquid discharged from the column is led to a vacuum filter.

When sufficient lead azide is gathered on one of the suction filters, the liquid from the column is discharged to the second vacuum filter. The lead azide is washed with distilled water until it is no longer alkaline. As soon as sufficient lead azide has been collected on the second suction filter, the liquid discharged from the column

is directed once more onto the first suction filter. Each time, the lead azide accumulated on the filter is washed until no alkalinity is shown.

The crystal structure of the lead azide is checked by examination under a microscope at frequent intervals from the beginning of the precipitation. The lead azide is precipitated as spherical crystals (Fig. 51).

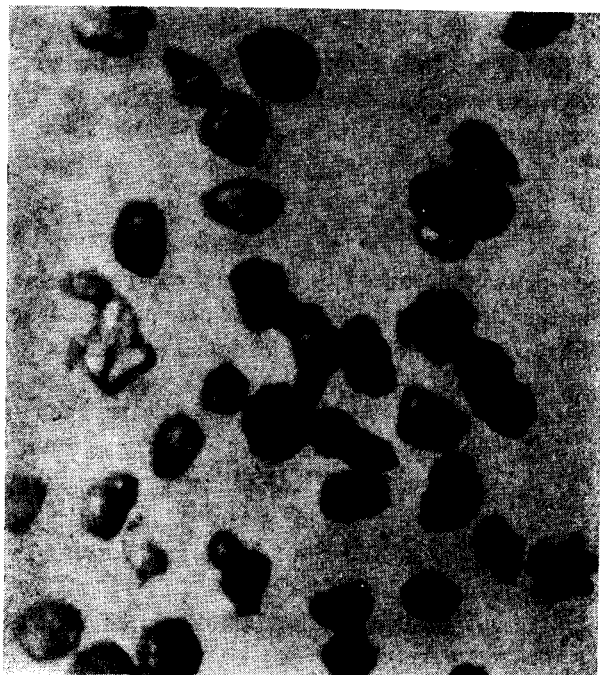

FIG. 51. Lead azide precipitated by Meissner method [111]. Courtesy J. Meissner.

The mother liquor and washing water sucked off from the vacuum filters are led into a destruction vat.

Cleaning and destruction. After the precipitation has been completed, the precipitation column and suction filters should be washed thoroughly with water. For cleaning, the precipitation column is filled with water, nitric acid and sodium nitrite are added, and the air agitation is switched on for half an hour. Then the contents are discharged and the column is rinsed again with water to remove the acid.

The mother liquor and washing waters from precipitation and cleaning carry some lead azide. All the mother liquors and washing waters are therefore collected in a vat, where nitric acid and sodium nitrite are added, and the liquid is stirred for half an hour. After the lead azide has been destroyed, the acid waste waters — which are no longer explosive — are discharged into a sump or the sewerage system.

Drying and sifting. The washed lead azide is removed from the filters while still damp, and carried in a bucket to the separate drying house. There it is laid in

a thin layer on trays covered with conductive rubber. The warm air used for drying is supplied from a separate room.

After the drying process, cold air is admitted for a short time into the drying room to cool the lead azide to ambient temperature and bring its humidity to that prevailing at room temperature.

Subsequently, the lead azide is transferred into composition boxes behind a protective wall. Sifting takes place in a separate building, on a special vibratory sieve. The explosive is poured out of the composition boxes into the sieve funnel in a safe place behind a protective wall. The sifted lead azide is collected in an empty composition box placed underneath.

Lead azide with a purity of more than 95%

Pure lead azide may be produced in the same equipment, but instead of lead nitrate and dextrin lead acetate is employed. The precipitation temperature is lower than in the manufacture of technical-grade lead azide (having a purity of less than 95%). All other operations are the same as already described.

SILVER AZIDE

Silver azide is slightly hygroscopic — at room temperature in a damp atmosphere it picks up approximately 2% of water.

Silver azide is a very vigorous initiator, almost as efficient as lead azide (cf. Table 32).

The researches of Wischin [113] and those of Garner and Maggs [84] have shown that metallic nuclei are formed during the slow thermal decomposition of silver azide. These researches were carried out by means of an optical microscope.

Sawkill [114] recently confirmed this observation using an electron microscope and found that silver is evolved as the result of slow reactions. In the early stage of decomposition intermediate compounds, richer in silver than azide, are formed. The pure metal, which is evolved only in the final stage of decomposition has a markedly oriented structure and a grain size of $0.1 \times 0.1 \times 0.05 \mu$.

Like lead azide, silver azide decomposes under the influence of ultra-violet irradiation. If the intensity of radiation is sufficiently high the crystals may explode (cf. p. 171).

The explosion of silver azide under the influence of brief, intensive irradiation was studied by Berchtold and Eggert [86] and Meerkamper [87]. The intensity of light causing the explosion of silver azide is 2.6 J/cm^2 , the electrical energy necessary to produce a flash with a half-life of 0.8 m/sec being 310 J.

The same problem was later investigated by Courtney-Pratt and Rogers [115]. They found that the energy required to cause silver azide to explode should be greater than $8 \times 10^{-4} \text{ cal per mm}^2$ of the crystal surface.

Eggert and Courtney-Pratt and Rogers state that the decomposition of silver azide under the influence of irradiation has a thermal character, i.e. that light absorbed by a thin surface layer of the crystal is degraded into heat in a very short time interval (less than $1/50 \mu\text{sec}$), whereupon explosion occurs by the normal thermal mechanism.

According to Bowden and Yoffe [116] other possible mechanisms should be considered, including direct photochemical decomposition. A number of experiments have been carried out by members of the Bowden school.

Thus, according to Rogers [117] when the surface of crystals which have been given a flash, but which have not exploded or broken down, is examined by an optical microscope, it can be seen that the crystal is much darkened on the irradiated face, and contains many irregular but parallel cracks. The cracks are not visible on the other side of the crystals suggesting that they penetrate only a short distance into it.

McAuslan [118] and Rogers [117] attempted to measure the time that elapses between the absorption of light by the silver azide and the ignition of the crystals. This proved to be less than $20 \mu\text{sec}$.

If silver azide has been sensitized by the dyestuff erythrosin (Rogers [117]) it is about 2.5 times more sensitive to photo-initiation than normal silver azide. Evans [119] examined the sensitization of silver azide by the incorporation of gold powder. He found that the critical light energy necessary for explosion is reduced by incorporating gold powder. The greatest effect was produced when the mixture contained 28% of gold by weight.

According to Bowden and Yoffe [116] these and other results suggest, that the initiation of flash decomposition may be of a true photochemical character.

These authors suggest the following mechanism for the initiation of photochemical decomposition of azides:

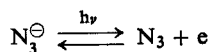

i.e. an N_3 radical is formed.

The spread of the explosion from the decomposed surface layer however depends on thermal factors, i.e. the heat liberated by the reaction is greater than that lost by self heating, conduction etc. The heat liberated during decomposition is sufficient to melt the surface of the azide and give rise to a reaction that will be self-supporting in the thermal sense.

The sensitizing action of gold can be interpreted by postulating that the gold particles act as electron traps.

Gray and Waddington [57,120] examined the physico-chemical properties of silver azide and state that its melting point is 300°C . On the basis of the latest opinion that the explosive decomposition of azides results from processes involving ions and electrons caused by imperfection and deficiencies in the crystal lattice (Jacobs and Tompkins [22]), the authors incorporated silver cyanide, $\text{Ag}_2(\text{CN})_2$,

into silver azide. The $(\text{CN})_2^{\ominus}$ ion has the same electron configuration as the N_3^{\ominus} ion and probably has the same linear structure and similar dimensions as N_3^{\ominus} ion.

It is assumed that the presence of silver cyanide increases the sensitiveness of silver azide at elevated temperatures; sensitized AgN_3 explodes at a lower temperature than the ordinary compound and the induction period is shorter.

	Ignition at 260°C after	Minimum ignition temperature
Pure AgN_3	induction 280 min	340°C
AgN_3 precipitated from a solution containing 10% of $\text{Ag}_2(\text{CN})_2$	induction 10 min	
AgN_3 precipitated from a solution containing more than 10% of $\text{Ag}_2(\text{CN})_2$	induction 1 min	270°C

The same authors investigated the kinetics of decomposition

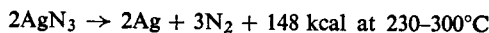

and found the approximate equation

$$\frac{d(\text{N}_2)}{dt} = k(\text{AgN}_3)^{2/3}$$

The activation energy is 35 kcal/mole.

The electrical conductivity of AgN_3 at a temperature above 160°C

$$\sigma = 1.60 \exp(-10.7 \text{ kcal}/RT)$$

is therefore very high.

Thus migration of the cation is possible, and the authors presume that this is the cause of the initiating property of silver azide.

Other authors quote the following values for the activation energy of the thermal decomposition of silver azide:

40.0 kcal/mole (Audubert [121])

29.0 kcal/mole (Haycock [122])

44.0 kcal/mole (below 190°C) (Bartlett, Tompkins and Young [123])

31.0 kcal/mole (above 190°C) (Bartlett, Tompkins and Young [123])

The ignition temperature is 273°C and is thus much lower than that of lead azide, although the sensitiveness of silver azide to impact is also lower than that of lead azide. Taylor and Rinkenbach [124] report that with a 0.5 kg weight a 77.7 cm drop is necessary to cause detonation of silver azide, whereas for mercury fulminate a 12.7 cm drop is sufficient.

The rate of detonation of a thin (0.1–0.5 mm) film of silver azide is about 1550 m/sec; that of the same film in an enclosed space about 1700 m/sec (Bowden and Williams [101]).

Silver azide, AgN_3 , is manufactured in the same way as lead azide, in aqueous solution, by action of sodium azide on silver nitrate.

CUPRIC AZIDE

Cupric azide, $\text{Cu}(\text{N}_3)_2$, is of great practical significance since it can be formed in addition to cuprous azide by long term action of lead azide on copper or its alloys.

Curtius and Rissom [41] prepared cupric azide by the action of an aqueous solution of sodium azide on an aqueous solution of cupric sulphate, obtaining the salt in a hydrated form. The anhydrous salt was prepared by Straumanis and Cirulis [125] in the form of dark brown, reddish sediment by reaction of lithium azide on cupric nitrate in an alcohol solution. Another method described by Curtius consists of reacting hydrazoic acid with metallic copper in an aqueous medium.

Green cupric azide has also been described (Dennis and Isham [44]). It is formed by the action of hydrazoic acid on cupric hydroxide or (according to Straumanis and Cirulis) on cupric oxide. It is sometimes grey in colour.

Cupric azide is insoluble in water, but is soluble in dilute acids and in acetic acid. It is decomposed by concentrated sulphuric acid, evolving nitrogen. It dissolves in an aqueous solution of ammonia and aliphatic amines to form a complex compound.

Boiling in water (Wöhler and Krupko [80]) leads to hydrolysis with the formation of basic cupric azide. Long-continued boiling causes complete hydrolysis to cupric oxide and free acid. Black cupric azide, $\text{Cu}(\text{N}_3)_2$, when exposed to the action of air for 2 months, is completely converted into a yellow basic salt. This is discussed later.

The ignition temperature of cupric azide is 202–205°C. The dry substance is exceptionally sensitive to friction, especially the green modification, and is often exploded by contact. It is also very sensitive to impact; the green modification is exploded by a 2 kg weight falling from a height of less than 1 cm, the black one from a drop of about 1 cm.

Its rate of detonation ranges between 5000 and 5500 m/sec.

Straumanis and Cirulis [125] emphasize its exceptionally strong initiating properties, viz 0.0004 g only of the substance is sufficient to detonate penthrite.

Basic cupric azide, $\text{Cu}(\text{OH})\text{N}_3$, prepared by Wöhler and Krupko, is yellow coloured. According to Straumanis and Cirulis it is less sensitive to friction and impact. It is exploded by a 1 kg weight falling from a height of 7–8 cm. Its ignition temperature is the same as that of the neutral salt (203–205°C).

Complex salts of cupric azide are also explosive. The salt $\text{Cu}(\text{NH}_3)_4(\text{N}_3)_2$ is much less sensitive to impact than cupric azide itself. The complex lithium-cupric salt $\text{Li}_4[\text{Cu}(\text{N}_3)_6]$ has exceptionally strong initiating properties.

OTHER METAL AZIDES

Martin [126] prepared nickel, cobalt, zinc and manganese azides by the action of an ether solution of hydrazoic acid on the dry metal carbonate. Cuprous azide, CuN_3 , was obtained in the form of a light grey sediment by the reaction of sodium azide with a solution of cuprous sulphate.

The preparation of ferric azide failed, however, due to the formation of basic ferric azide. A complex compound was obtained by Martin from chromium hydroxide and hydrazoic acid. It contained no chromium or N_3^- ions and has the probable formula of a complex compound $[Cr(N_3)_4]H$.

Martin carried out extensive research into the explosive properties of the azides of various metals (Table 33). The high sensitiveness of cuprous azide to impact is noteworthy.

TABLE 33
EXPLOSIVE PROPERTIES OF AZIDES (ACCORDING TO MARTIN [126])

Azide	Ignition temperature °C	Sensitiveness to impact (work in kgm/cm ²)	Minimum initial charge, g	
			trinitrotoluene	tetryl
Silver	273	13.97	0.07	0.02
Lead	327	4.76	0.09	0.025
Mercurous	281	4.76	0.145	0.045
Cadmium	291	18.54	0.04	0.01
Zinc	289	17.53		
Cuprous	174	2.66	0.095	0.025
Nickel	200	5.46		
Cobalt	148	5.88		
Manganese	203	6.30		
Barium	152	7.70		
Strontium	169	9.10		
Calcium	158	10.14		
Lithium	245	(no explosion)		
Thallium	320	16.18	0.115	0.07

Mercuric azide, $Hg(N_3)_2$, occurs in two allotropic modifications: α (orthorhombic) and β (monoclinic), like lead azide (Miles [75]; Garner and Gomm [37]). The latter is obtained like β -lead azide, by slow diffusion of the solutions. During crystallization spontaneous explosion may occur. Mercuric azide also explodes during crystallization from a hot, aqueous solution.

The physical properties of mercurous azide — $Hg_2(N_3)_2$ — were examined by Evans and Yoffe [33] and its photochemical decomposition by Deb and Yoffe [26]. The activation energy was found to be 8.4 kcal/mole.

Cadmium azide may also detonate spontaneously, but under different experimental conditions, i.e. when a rod of metallic cadmium is immersed in hydrazoic acid and cadmium azide is formed on the surface of the rod (A. T. Thomas [127]).

Gray and Waddington [128] have produced a graph showing changes in the rate of detonation in relation to the heat of formation of various azides (Fig. 52).

The same authors [57] determined the heats of formation and decomposition of a number of azides (Table 34).

TABLE 34

Salt	Heat of formation - ΔH_f
	kcal/mole
HN ₃ gas	-71.66
HN ₃ liquid	-64.37
LiN ₃	- 2.58
NaN ₃	- 5.08
KN ₃	- 0.33
RbN ₃	+ 0.07
CsN ₃	+ 2.37
NH ₄ N ₃	-26.79
CaN ₆	-11.03
SiN ₆	- 1.72
BaN ₆	+ 5.32
CuN ₃	-67.23
CuN ₆	-140.4
AgN ₃	- 74.17
Hg ₂ N ₆	-141.5
TlN ₃	-55.78
PbN ₆	-115.5
CdN ₆	ca. -108

The heat of decomposition to metal and nitrogen, ΔH , has of course, the opposite value $\Delta H = -\Delta H_f$.

With regard to their sensitiveness to ignition by light, the azides of monovalent metals may be ranged as follows:

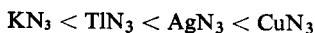

According to Deb [129] the corresponding values are: for TlN₃ - 92; AgN₃ - 39; CuN₃ - 12 J.

The activation energies of azides not mentioned above are shown in Table 35.

TABLE 35

Salt	Activation energy	Author
NaN ₃	34.0 kcal/mole	Garner and Marke [130]
KN ₃	36.0 kcal/mole	Garner and Marke [130]
Ba(N ₃) ₂	21.0-27.0 kcal/mole	Jacobs and Tompkins [22]
Sr(N ₃) ₂	20.0 kcal/mole	Maggs [131]
Ca(N ₃) ₂	18.0 kcal/mole	Marke [132]
Cu(N ₃)	26.5 kcal/mole	Singh [133]

The properties of thallos azide have been examined in detail by Gray and Waddington [120].

Thallos azide is a yellow, crystalline substance, m.p. 334°C. The crystal structure as determined by X-ray analysis points to the isomorphism of TlN_3 with KN_3 and RbN_3 azides.

Thallos azide is sensitive to the action of light and decomposes under its influence to evolve metallic thallium.

The ignition temperature, as determined by throwing a test sample on a heated metallic surface, is 490°C. The activation energy of its pre-explosive state as calculated by the authors is said to be approximately 40 kcal/mole.

The introduction of a thallium salt with a bivalent anion, e.g. thallos sulphide, Tl_2S , produces defects in the crystal lattice. According to a recent view (Jacobs

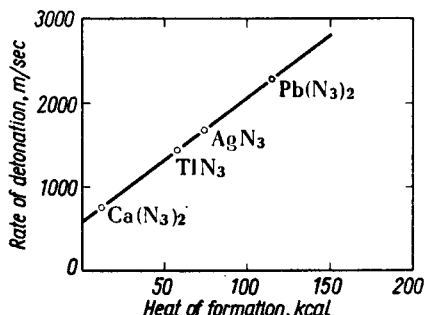
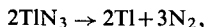

FIG. 52. The variation of the rate of detonation with heat of formation of azides, according to Gray and Waddington [128].

and Tompkins [22]), the explosive decomposition of azides is caused by imperfection and deficiencies of the crystal lattice. Due to defects produced artificially with thallium sulphide, the ignition temperature is reduced, e.g. the ignition temperature of thallium azide containing 18% of Tl_2S is reduced to 420°C.

Deb and Yoffe [134] examined the decomposition of thallos azide under the action of ultra-violet light in the wavelength region 3200–3800 Å. Two exciton bands 3415 and 3348 Å have been observed in thallos azide by low-temperature spectroscopy (Nikitine and Gross's method). The refractive index has been measured by the Brewster angle method, the electron energy levels have been estimated and the results of the photochemical decomposition have been related to the electron energy level and to measurement of photoconductivity [33].

The overall reaction is



where nitrogen gas is formed by the reaction at the surface

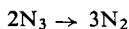

The activation energy was found to be 3.2 ± 0.1 kcal/mole. The suggested mechanism of photochemical decomposition is as follows:

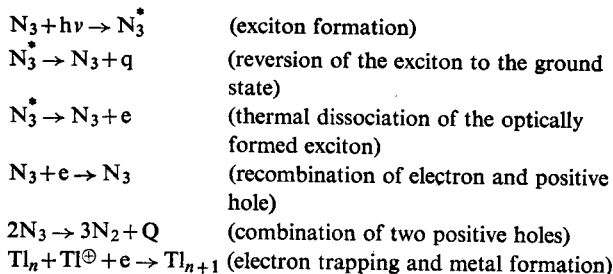

The electrical conductivity of TiN_3 is very high: $6-5 \times 10^{-5}/275^\circ\text{C}$ (i.e. a million times higher than that of KN_3).

The explosive properties of sodium, calcium, strontium and barium azides have been investigated at the Chemisch-Technische Reichsanstalt [135]. These azides differ markedly from lead, silver and cupric azides in that they show none of the properties of primary explosives. All three may be ignited by a spark, a glowing wire or the flame of blackpowder. Calcium azide burns most rapidly and has distinctly marked explosive properties. Larger quantities of it may explode when ignited in a closed tin, while strontium and barium merely burn violently. Calcium azide detonates under the influence of a detonating cap. The sodium azide does not decompose in these conditions. The other azides show weak decomposition under the influence of a standard (No. 3) detonator. Their most important properties are tabulated below.

TABLE 36

Azide	Ignition temperature $^\circ\text{C}$	Lead block expansion cm^3	Heat of decomposition kcal/mole
Sodium	no ignition up to 300	0	—
Calcium	171-176	120	—
Strontium	190-202	30-90	—
Barium	190-200	25-30	13-14

Tompkins *et al.* [22, 85] studied the photochemical decomposition of potassium and barium azide. Originally they found that the rate of photolysis was proportional to the square of the intensity of the radiation.

In more recent studies, Jacobs, Tompkins and Young [136] examined the rate of evolution of nitrogen from barium azide as a criterion of the rate of photolysis, and have shown the reaction to be more complex than was previously indicated. A mechanism for the photolysis involving the production and reaction of both excitons and positive holes has been formulated.

According to Ficherouille and Kovache [137] barium azide has a low sensitiveness to impact (a 2 kg weight falling from 100 cm causes 14% of explosions) but it is very sensitive to friction. It does not possess the properties of a primary explosive,

but in large quantities may burn very violently. The toxicity of BaN_6 is negligible, but in the presence of strong acids it decomposes to evolve strongly poisonous hydrazoic acid.

Strontium azide possesses similar properties, but is highly sensitive to the action of even weak acids (e.g. with CO_2 it forms SrCO_3) and easily is hydrolysed.

Barium and strontium azides are used in the manufacture of valves in radio technology.

Ficherouille and Kovache recommend two methods for the manufacture of barium azide. One of them is based on the reaction of ethyl nitrite with hydrazine in the presence of barium hydroxide: 19.5 kg of ethyl nitrite is cooled with brine to -15°C when a mixture of 31 kg of $\text{Ba}(\text{OH})_2$ in 100 l. of the 10% hydrazine hydrate previously cooled to -15°C is added at a rate of 4 l. per hr. The whole is stirred for 10 hr while room temperature is attained gradually. A stream of CO_2 is allowed to pass through the liquid to precipitate excess barium. Barium carbonate is then removed by filtration. The filtrate is greatly concentrated and BaN_6 precipitated by the addition of alcohol. Thus 12.6 kg of BaN_6 is obtained i.e. 44% of the theoretical yield. A yield up to 55% may sometimes be obtained. The other method is based on the double decomposition of $\text{Ba}(\text{ClO}_4)_2$ and KN_3 . Sparingly soluble KClO_4 is precipitated while BaN_6 passes into solution. This method gives a product which is less pure and not suitable for valve manufacture.

Sodium azide (see above, p. 189 and Table 36) can be decomposed on heating but it is of low sensitiveness to impact or friction and is not listed as an explosive in transport regulations. According to Günther *et al.* [138] rubidium azide is much more sensitive to impact and friction than sodium azide. Günther believes this to be due to the fact that the radius of the orbit of nitrogen atoms in rubidium azide is much shorter than that in sodium azide.

Curtius [1] who prepared ammonium azide did not notice its explosive properties. They were reported by Berthelot [139] who found ammonium azide to be an endothermic substance with a heat of formation $-\Delta H_f$ of -19.0 kcal.

Berthelot and Vieille [140] reported that the explosive decomposition of ammonium azide proceeds according to the following equation:

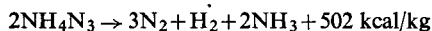

Volume of gases (V_0) is 1148 l./kg

Temperature of explosion t , 1350–1400°C

Specific pressure (f), 7290 m

A low explosion temperature together with a great amount of gaseous products and a high specific pressure suggested the use of ammonium azide as a propellant explosive. In practice the use of the substance, however, is prevented by its high volatility.

Azides of complex salts with ammonia ("ammines") are described below (p. 231).

Among other inorganic azides those prepared by Wiberg *et al.* [141] i.e. boron, $\text{B}(\text{N}_3)_3$, and silicon, $\text{Si}(\text{N}_3)_4$, azides are of interest. Grundman and Rätz [142] ob-

tained highly explosive "phosphorous azide", P_3N_{21} . As early as 1915 Curtius and Schmidt [143] described the preparation of $SO_2(N_3)_2$ from SO_2Cl_2 and NaN_3 . By the action of SO_3 on KN_3 Lehman and Holznagel [144] obtained an addition compound, $KN_3 \cdot 2SO_3$, which is transformed on heating into disulphuryl azide, $S_2O_5(N_3)_2$, a highly explosive substance. Sundermeyer [145] described recently silyl-azides, e.g. $(CH_3)_2Si(N_3)_2$.

Halogen azides, e.g. IN_3 , BrN_3 , ClN_3 , FN_3 are also known. They are, however, highly unstable.

An extensive review of physics and chemistry of inorganic azides is given by Evans, Yoffe and Gray [74].

ORGANIC AZIDES

In the search for powerful explosives, attempts have been undertaken to introduce the $-N_3$ group into organic molecules. Generally this so enhances their sensitiveness to friction and impact that they cannot be used. Moreover, the increase in explosive power is not always commensurate with the rise in the manufacturing costs of the substance.

Triazoethanol nitrate $N_3 \cdot CH_2CH_2 \cdot ONO_2$ (II) is an example of an organic aliphatic azide and nitric ester. It was prepared by T. Urbański and Rusiecki [146] by the following steps:

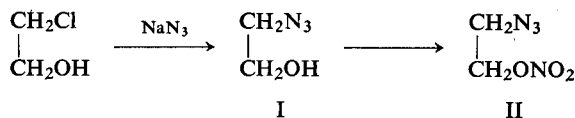

Compound (I) was obtained by Forster *et al.* [147]. Substance (II) is a liquid explosive resembling nitroglycerine in its properties: it gives the same lead block expansion and a rate of detonation ranging from 2000 to 6550 m/sec (in a lead pipe 17/21 mm diameter). Mixtures with ammonium nitrate give an even larger expansion and a higher rate of detonation than analogous mixtures with nitroglycerine. Triazoethanol nitrate has a higher sensitiveness to impact than has nitroglycerine. The ignition temperature is $190^\circ C$ in a closed vessel. According to Urbański and Rusiecki the alcohol itself, triazoethanol (I), is an explosive substance and gives a lead block expansion of 130 cm^3 .

Azides containing the $-CON_3$ group have received little attention, and have poor prospects for practical use. They are formed either by the action of nitrous acid on hydrazides or by the action of sodium azide on acid chlorides:

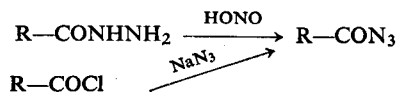

Some azides are capable of the so-called Curtius rearrangement, which results in the formation of isocyanates with loss of nitrogen.

Organic azides with initiating properties may be exemplified by the following substances (Curtius [148]): oxamidoazide (III) and triazide of trimesic acid (IV):



III

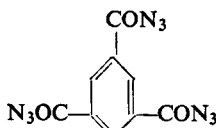

IV

The first of these is obtained by the action of nitrous acid on oxamidohydrazide. It is unstable and decomposes explosively at 115°C. The second is formed by the action of nitrous acid on the trihydrazide of trimesic acid. The explosive properties of neither of these azides have been reported.

Diaziide of carbonic acid (V) is exceptionally sensitive to friction: it explodes on contact with a glass rod (Curtius and Heidenreich [149]) Succinyl azide [150] and other acyl azides [151] behave similarly.

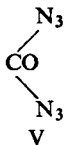

Organic azides in which the N_3 group is combined with an aromatic radical may be prepared by a general method based on the action of hydroxylamine on a diazo compound (Mai [152]):

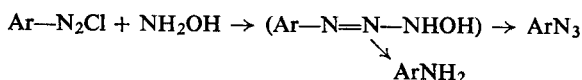

The initial amine is formed again, together with azide.

Tetra-azido quinone (VI) was obtained by Šorm [153], by the action of sodium azide on chloranil. This explosive is powerful but of no practical use due to its inadequate stability; its ignition temperature is low: 91°C.

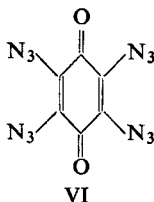

VI

The organic derivatives of hydrazoic acid which contain an aromatic ring with nitro groups comprise an important group of initiators. Picryl azide (VII), m.p. 89–90°C is a typical example. It has been prepared both by the action of nitrous acid on trinitrophenylhydrazine (Purgotti [154], Schrader [155] and Korczyński [156]) and by the action of sodium azide on picryl chloride. Rathsburg [157] suggested

the use of picryl azide as an initiator but its initiating properties proved to be too weak and the compound has not found practical application.

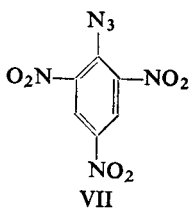

Trinitrobenzoyl azide (VIII) was prepared by Vasilevskii, Blokhshtein and Kustria [158] by the action of sodium azide on trinitrobenzoyl chloride

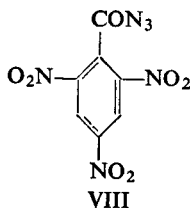

Trinitrotriazidobenzene (IX) is the only representative of organic azides possessing properties of primary explosives which has some prospect of practical use. Turek [159] prepared it by the action of sodium azide on sym-trichlorotrinitrobenzene (Vol. I. p. 469) and on the basis of its properties which he himself determined he suggested its use as an initiator.

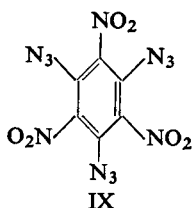

Trinitrotriazidobenzene is insoluble in water, easily soluble in acetone and moderately soluble in chloroform and alcohol. It is not hygroscopic and is moisture-resistant. In the presence of moisture it has no effect on iron, steel, copper or brass. At its melting point, 131°C, it undergoes decomposition to evolve nitrogen and to form benzotrifuroxane ("hexanitrosobenzene") also an explosive substance (Vol. I, p. 603).

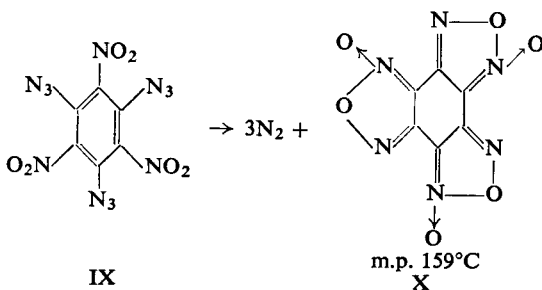

The same reaction also occurs at a lower temperature. 0.665% of the substance decomposed at 20°C to form benzotrifuroxane in 3 years; 2.43% at 35°C in one year; 0.65% at 50°C in 10 days; and at 100°C the substance underwent complete change in 14 hr. This decomposition is not, however, autocatalytic. This reaction — the formation of furoxane derivatives from aromatic azides with nitro group in the *ortho*-position — is of a general character (Boyer *et al.* [160]). Despite the ease with which it decomposes trinitrotriazidobenzene has not been rejected for use as an initiator. In some countries large scale experiments are in progress to examine the possibilities of developing its practical application.

Trinitrotriazidobenzene is less sensitive to impact and friction than mercury fulminate.

As an explosive the substance is very powerful. Its expansion in the lead block is about 500 cm³, i.e. its explosive strength is midway between that of tetryl and penthrite. At a density of 1.54 it detonates at a rate of 7500 m/sec.

The specific gravity of trinitrotriazidobenzene is 1.8054. Under a pressure of 3000 kg/cm² it gives a density of 1.751 and under 5000 kg/cm² the density achieved is 1.7526. A pressure higher than 300 kg/cm² may make it "dead pressed". 0.02 g of the substance compressed under the pressure of 300 kg/cm² detonates trinitro-toluene, and 0.01 g detonates tetryl. It is therefore one of the most vigorous initiators.

As a starting material for the preparation of sym-trinitrotriazidobenzene, 1,3,5-trichlorobenzene is used. It is obtained by the chlorination of aniline and the removal of the amino group. Nitration to the trinitro derivative is described in Vol. I. The final reaction is simple: powdered 1,3,5-trichloro-2,4,6-trinitrobenzene is added to an aqueous alcohol solution of sodium azide. The precipitated product is washed with alcohol and water and dried at a moderate temperature. The product so obtained may be purified by crystallization from chloroform.

A powerful initiator in which azido groups are combined with a heterocyclic ring is cyanuric triazide (XI)

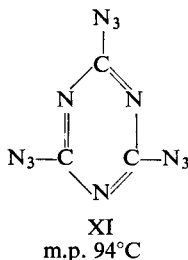

It was obtained by Ott and Ohse [161] in the following way:

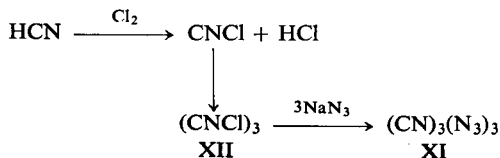

On reaction with chlorine, hydrogen cyanide gives cyanogen chlorides, forming a trimer—cyanuric chloride (XII). The latter is a liquid with a melting point of 146°C and a boiling point of 196°C. Next, cyanuric triazide (XI) is obtained by the action of sodium azide in an aqueous solution, at room temperature on compound (XII).

Cyanuric triazide is insoluble in water, sparingly soluble in cold alcohol and readily soluble in hot alcohol, acetone, benzene, chloroform, ether, and molten trinitrotoluene. It is slightly hygroscopic and slightly volatile. It irritates the skin causing dermatitis. Its heat of formation $-\Delta H_f$ is 219 kcal/mole (H. Muraour [162]).

Much attention has been devoted to this substance as an initiator since it was found that its initiating properties are stronger than those of mercury fulminate. However it proved to be highly dangerous to handle and sensitive to impact and friction; it has been known to explode during manufacture, e.g. during drying. Large crystals, which explode even under the pressure of a rubber cork, are particularly dangerous. Attempts to press it into capsules often resulted in explosion. This accounts for the fact that the substance has found no practical application. It is nevertheless very interesting from the theoretical point of view. The following data are characteristic of its properties.

The ignition temperature, when heated at the rate of 20°C/min, is 205–208°C i.e. higher than that of fulminate, but decomposition becomes evident on heating at a temperature slightly exceeding 100°C. The substance is exploded by a drop three times less than that of mercury fulminate.

The rate of detonation at a density of 1.15 is 5545 m/sec (Kast and Haid [99]), it is therefore an initiator that detonates extremely fast.

The initiating properties of the substance are characterized by the following figures (Taylor and Rinckenbach [163]) which indicate the amounts of primary explosive required to initiate different high explosives compressed under a pressure of about 14 kg/cm².

Trinitrotoluene	{ 0.10 g of cyanuric triazide 0.26 g of mercury fulminate
Picric acid	{ 0.05 g of cyanuric triazide 0.21 g of mercury fulminate
Tetryl	{ 0.14 g of cyanuric triazide 0.24 g of mercury fulminate

A new type of initiator containing the azido group has recently been described by Głowiak [164]. These are salts of heavy metals (e.g. lead), phenols of phenolic acids containing nitro groups and azido group, e.g. the plumbous salt of dinitro-azidophenol (XIII) and 5-nitro-3-azidosalicylic acid (XIV):

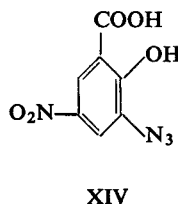
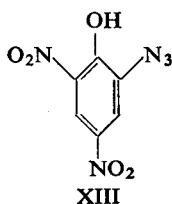

Plumbous salts of these compounds are very sensitive to mechanical and thermal impulses but have no distinctly marked ability to initiate secondary explosives and are similar to lead styphnate in their properties.

Interesting material with which the mechanism of decomposition of organic azides was investigated is triphenylmethyl azide

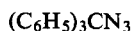

Saunders and Ware [165] examined its thermal decomposition in the molten state at 170–200°C and found it gives a benzophenone anil $(\text{C}_6\text{H}_5)_2\text{C}=\text{NC}_6\text{H}_5$. They suggest the following mechanism for the decomposition

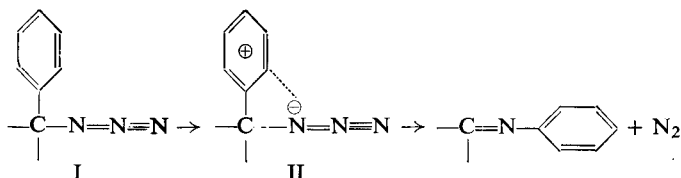

The transition state is represented as the resonance hybrid of (I) and (II).

The same product was obtained by Deb and Yoffe [26] as the result of photochemical decomposition of the substance. The activation energy of this reaction was found to be 8.82 kcal/mole. See also [33].

The chemistry of organic azides has been the subject of many theoretical and practical investigations. Apart from their application as explosives some organic azides possess interesting pharmacological and bacteriostatic properties.

A new group of azides containing silicon of general formulae

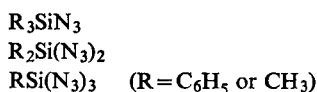

were recently prepared by Reichle [166]. He also described similar compounds with other group IV elements: Ge, Sn and Pb, e.g. $(\text{C}_6\text{H}_5)_3\text{PbN}_3$.

The compounds are remarkably stable.

An extensive review of the chemistry of aliphatic and aromatic azides is given by Boyer and Canter [167] and Gray [168]. Organic azides are subject to various reactions such as the Bergmann degradation and the synthesis of peptides, the well known Curtius rearrangement, the Darapsky synthesis of α -aminoacids [169], for synthesis of triazoles [170], tetrazoles ("Schmidt reaction") [169] and [171] etc. These reactions lie beyond the scope of the present book.

LITERATURE

1. T. CURTIUS, *Ber.* **23**, 3023 (1890); **24**, 3341 (1891); **29**, 759 (1896); *J. prakt. Chem.* [2], **43**, 207 (1891); **48**, 273 (1893); **91**, 1, 415 (1915).
2. R. STERN, *Klin. Wochenschr.* **6**, 304 (1927).
3. PRAVDIN and SHAKHNOVSKAYA, *Farmakologiya i toksikologiya* **8**, 50 (1948).

4. SHAKHNOVSKAYA, *Farmakologiya i toksikologiya* **13**, 3, 4 (1950).
5. J. THIELE, *Ber.* **44**, 2524, 3336 (1911).
6. E. C. FRANKLIN, *J. Am. Chem. Soc.* **46**, 214 (1924); **56**, 568 (1934).
7. L. B. HENDRICKS and L. PAULING, *J. Am. Chem. Soc.* **47**, 2917 (1925).
8. L. K. FREVEL, *J. Am. Chem. Soc.* **58**, 779 (1936).
9. F. J. LLEWELLYN and F. E. WHITMORE, *J. Chem. Soc.* **1947**, 881.
10. I. E. KNAGGS, *Proc. Roy. Soc. (London)* **A 150**, 5776 (1935).
11. A. LANGSETH, J. R. NIELSEN and J. U. SØRENSEN, *Z. physik. Chem. (B)* **27**, 100 (1934).
12. G. HERZBERG, F. PATAT and H. VERLEGER, *Z. Electrochem.* **41**, 522 (1935).
13. E. H. EYSTER, *J. Chem. Phys.* **8**, 135 (1940).
14. E. AMBLE and B. P. DAILEY, *J. Chem. Phys.* **18**, 1442 (1950).
15. K. CLUSIUS and H. R. WEISSER, *Helv. Chim. Acta* **35**, 1548 (1952).
16. E. A. BRAUDE, *Ann. Rep. Progr. Chem.* **42**, 105 (1945).
17. V. HENRI, *International Critical Tables* **5**, 359, McGraw-Hill, New York, 1929.
18. W. KUHN and E. BRAUN, *Z. physik. Chem.* **138**, 281 (1930).
19. H. MOHLER, *Helv. Chim. Acta* **26**, 121 (1943).
20. YU. N. SHEINKER, *Dokl. Akad. Nauk SSSR* **77**, 1043 (1951).
21. YU. N. SHEINKER and YA. K. SYRKIN, *Izv. Akad. Nauk SSSR, Ser. Fiz.* **14**, 478 (1950).
22. P. W. M. JACOBS and F. C. TOMPKINS, *Proc. Roy. Soc. (London)* **A 215**, 254 (1952).
23. B. L. EVANS and A. D. YOFFE, *Proc. Roy. Soc. (London)* **A 250**, 346 (1959); *Nature* **183**, 1241 (1959).
24. F. C. TOMPKINS and D. A. YOUNG, *Proc. Roy. Soc. (London)* **A 236**, 10 (1956).
25. A. C. MCLAREN and G. F. ROGERS, *Proc. Roy. Soc. (London)* **A 240**, 484 (1957).
26. S. K. DEB and A. D. YOFFE, *Proc. Roy. Soc. (London)* **A 256**, 528 (1960), and unpublished work.
27. A. C. MCLAREN, Ph.D. Thesis, Cambridge, 1957.
28. E. H. EYSTER, *J. Chem. Phys.* **8**, 135 (1940).
29. D. A. DOWS and G. C. PIMENTEL, *J. Chem. Phys.* **23**, 1258 (1955).
30. E. H. EYSTER and R. H. GILLETTE, *J. Chem. Phys.* **8**, 369 (1940).
31. E. LIEBER, D. R. LEVERING and L. J. PATTERSON, *Anal. Chem.* **23**, 1594 (1951); E. LIEBER, C. N. RAMACHANDRA RAO, T. S. CHAO and C. W. W. HOFFMAN, *Anal. Chem.* **29**, 916 (1957).
32. J. H. BOYER, *J. Am. Chem. Soc.* **73**, 5248 (1951).
33. B. L. EVANS and A. D. YOFFE, *J. Chem. Phys.* **30**, 1437 (1959).
34. P. GRAY and T. C. WADDINGTON, *Trans. Faraday Soc.* **53**, 901 (1957).
35. L. KAHOVEC, K. W. F. KOHLRAUSCH, A. W. REITZ and J. WAGNER, *Z. physik. Chem. (B)* **39**, 431 (1938).
36. K. W. F. KOHLRAUSCH and J. WAGNER, *Monatsh. Chem.* **77**, 180 (1947).
37. W. E. GARNER and A. S. GOMM, *J. Chem. Soc.* **1931**, 2133.
38. A. DELAY, C. DUVAL and J. LECOMTE, *Bull. soc. chim. France* **12**, 581 (1945).
39. L. J. BELLAMY, *The Infra-red Spectra of Complex Molecules*, Methuen, London, 1958.
40. D. MENDELEYEV, *Ber.* **23**, 3470 (1890).
41. T. CURTIUS and J. RISSOM, *J. prakt. Chem. [2]*, **58**, 263 (1898).
42. T. CURTIUS and A. DARAPSKY, *J. prakt. Chem. [2]*, **61**, 409 (1900).
43. A. J. SOFIANOPOULOS, *Bull. soc. chim. France [4]*, **5**, 614 (1909).
44. L. M. DENNIS and H. ISHAM, *J. Am. Chem. Soc.* **29**, 18, 216 (1907); *Ber.* **40**, 462 (1907).
45. R. MEYER and H. J. SCHUMACHER, *Z. physik. Chem. (A)* **170**, 33 (1934).
46. T. CURTIUS, *Ber.* **23**, 3023 (1890).
47. A. R. JOYNER, according to J. TAYLOR, *Detonation in Condensed Explosives*, p. 158, Oxford University Press, London, 1952.
48. A. O. BECKMAN and R. G. DICKINSON, *J. Am. Chem. Soc.* **50**, 1870 (1928); **52**, 124 (1930).
49. K. STEWART, *Trans. Faraday Soc.* **41**, 663 (1945).

50. F. O. RICE and M. FREAMO, *J. Am. Chem. Soc.* **73**, 5529 (1951); **75**, 548 (1953).
51. J. L. MADOR and M. C. WILLIAMS, *J. Chem. Phys.* **22**, 1627 (1954).
52. D. A. DOWS, G. C. PIMENTEL and E. WHITTLE, *J. Chem. Phys.* **23**, 1606 (1955).
53. G. PANNETIER and A. G. GAYDON, *J. chim. phys.* **48**, 331 (1951).
54. R. G. W. NORRISH, G. PORTER and B. A. THRUSH, *Proc. Roy. Soc. (London)* **A 216**, 156 (1953).
55. B. A. THRUSH, *Proc. Roy. Soc. (London)* **A 235**, 143 (1956).
56. A. O. BECKMAN and R. G. DICKINSON, *J. Am. Chem. Soc.* **50**, 1870 (1928); **52**, 124 (1930).
57. P. GRAY and T. C. WADDINGTON, *Proc. Roy. Soc. (London)* **A 235**, 106, 481 (1956).
58. E. D. BECKER, G. C. PIMENTEL and M. VAN THIEL, *J. Chem. Phys.* **26**, 145 (1957).
59. J. L. FRANKLIN, J. T. HERRON, P. BRADT and V. H. DIBELER, *J. Am. Chem. Soc.* **80**, 6188 (1958).
60. S. N. FONER and R. L. HUDSON, *J. Chem. Phys.* **28**, 719 (1958).
61. K. GLEN, *Ber.* **61**, 702 (1928).
62. D. ALEKSEYEV, *Zh. fiz. chim.* **2**, 535 (1931).
63. F. SEEL and R. SCHWAEBEL, *Z. anorg. Chem.* **274**, 169 (1953).
64. G. STEDMAN, *J. Chem. Soc.* **1959**, 2943, 2949.
65. W. WISLICENUS, Ger. Pat. 66813 (1892); *Ber.* **25**, 2084 (1892).
66. H. CLUSIUS and E. EFFENBERGER, *Helv. Chim. Acta* **38**, 1834, 1843 (1955).
67. H. CLUSIUS and H. KNOFF, *Helv. Chim. Acta* **39**, 681 (1956).
68. J. THIELE, *Ann.* **270**, 10 (1892).
69. A. SABANEYEV, *Z. anorg. Chem.* **20**, 28 (1899).
70. P. JANNASCH and A. JAHN, *Ber.* **38**, 1576 (1905).
71. J. W. TURRENTINE and J. M. OLIN, *J. Am. Chem. Soc.* **37**, 1114 (1905).
72. S. TANATAR, *Ber.* **35**, 1810 (1902).
73. L. F. AUDRIETH, *Chem. Rev.* **15**, 169 (1934).
74. B. L. EVANS, A. D. YOFFE and P. GRAY, *Chem. Rev.* **59**, 515 (1959).
75. F. D. MILES, *J. Chem. Soc.* **1931**, 2532.
76. L. V. AZÁROFF, *Z. Krist.* **107**, 362 (1956).
77. P. GRAY and T. C. WADDINGTON, *Nature* **176**, 653 (1955).
78. A. SOLONINA, *Z. ges. Schiess- u. Sprengstoffw.* **5**, 41, 67 (1910).
79. A. MAJRICH, *Z. ges. Schiess- u. Sprengstoffw.* **31**, 147 (1936).
80. L. WÖHLER and W. KRUPKO, *Ber.* **46**, 2056 (1913).
81. A. M. YUILL, Ph.D. Thesis, Cambridge, 1953, according to F. P. BOWDEN and A. D. YOFFE [116].
82. A. C. McLAREN, unpublished work (1955), according to F. P. BOWDEN and A. D. YOFFE [116].
83. G. TODD and E. PARRY, *Nature* **181**, 260 (1958).
84. W. E. GARNER and J. MAGGS, *Proc. Roy. Soc. (London)* **A 172**, 299 (1939).
85. J. G. N. THOMAS and F. C. TOMPKINS, *Proc. Roy. Soc. (London)* **A 209**, 550 (1951).
86. J. BERCHTOLD and J. EGGERT, *Naturwiss.* **40**, 55 (1953).
87. B. MEERKAMPER, *Z. Elektrochem.* **58**, 387 (1954).
88. J. EGGERT, *Physik. Bl.* **12**, 549 (1954).
89. M. HAÏSSINSKY and R. J. WALDEN, *Compt. rend.* **208**, 2067 (1939).
90. P. L. GÜNTHER, L. K. LEPIN and K. K. ANDREYEV, *Z. Elektrochem.* **36**, 218 (1930).
91. J. V. R. KAUFMAN, Discussion Roy. Soc., Initiation and Growth of Explosion in Solids, *Proc. Roy. Soc. (London)* **A 246**, 219 (1958).
92. J. M. GROOOCK, Discussion Roy. Soc., Initiation and Growth of Explosion in Solids, *Proc. Roy. Soc. (London)* **A 246**, 225 (1958).
93. R. WALLBAUM, *Z. ges. Schiess- u. Sprengstoffw.* **34**, 126, 197 (1939).
94. F. P. BOWDEN and K. SINGH, *Proc. Roy. Soc. (London)* **A 227**, 22 (1954).
95. F. P. BOWDEN and J. MCAUSLAN, *Nature* **178**, 408 (1956).

96. H. SUDO, Kristalle des Bleiazids, *Rep. Fac. Eng., Chuo University, Tokyo*, February 1958.
97. J. I. EVANS and A. M. YUILL, Discussions Roy. Soc., Initiation and Growth of Explosion in Solids, *Proc. Roy. Soc. (London) A* **246**, 176 (1958).
98. G. J. BRYAN and E. C. NOONAN, Discussion Roy. Soc., Initiation and Growth of Explosion in Solids, *Proc. Roy. Soc. (London) A* **246**, 167 (1958).
99. H. KAST and A. HAID, *Angew. Chem.* **37**, 973 (1924).
100. *Jahresber. Chem.-Techn. Reichsanstalt* **8**, 122 (1929).
101. F. P. BOWDEN and H. T. WILLIAMS, *Proc. Roy. Soc. (London) A* **208**, 176 (1951).
102. A. S. HAWKES and C. A. WINKLER, *Can. J. Research* **25**, 548 (1947).
103. G. T. ROGERS and P. L. HARRISON (1955), according to F. P. BOWDEN and A. D. YOFFE [116].
104. T. L. DAVIS, *The Chemistry of Powder and Explosives*, J. Wiley, New York, 1943.
105. G. W. C. TAYLOR and A. T. THOMAS (1957), according to F. P. BOWDEN and A. D. YOFFE [116].
106. F. W. BROWN, D. J. KUSLER and F. C. GIBSON, U.S. Bureau of Mines, Techn. Paper 3852, Washington, 1946.
107. W. E. GARNER, *Trans. Faraday Soc. Symposium of Solid Phase Reactions* (1938).
108. W. FEITKNECHT and M. SAHLI, *Helv. Chim. Acta* **37**, 423 (1954).
109. CIOS-XXVII 38, Manufacture of Initiating Explosives.
110. J. MEISSNER, Brit. Pat. 500711 (1939).
111. J. MEISSNER, private information (1964).
112. Private information.
113. A. WISCHIN, *Proc. Roy. Soc. (London) A* **172**, 314 (1939).
114. J. SAWKILL, *Proc. Roy. Soc. (London) A* **172**, 135 (1955).
115. J. S. COURTNEY-PRATT and G. T. ROGERS, *Nature* **175**, 652 (1955).
116. F. P. BOWDEN and A. D. YOFFE, *Fast Reactions in Solids*, p. 88, Butterworths, London, 1958.
117. G. T. ROGERS, Ph.D. Thesis, Cambridge, 1955, according to [116].
118. J. H. MCAUSLAN, Ph.D. Thesis, Cambridge, 1957, according to [116].
119. B. L. EVANS, Ph.D. Thesis, Cambridge, 1957, according to [116].
120. P. GRAY and T. C. WADDINGTON, *Chem. Ind.* 1255 (1955).
121. R. AUDUBERT, *Trans. Faraday Soc.* **35**, 197 (1939); *J. Chem. Phys.* **49**, 275 (1952).
122. E. W. HAYCOCK—see *Chemistry of the Solid State* by W. E. GARNER (Ed.), p. 238, Butterworths, London, 1955.
123. B. E. BARTLETT, F. C. TOMPKINS and D. A. YOUNG, Discussion Roy. Soc., Initiation and Growth of Explosion in Solids, *Proc. Roy. Soc. (London) A* **246**, 206 (1958).
124. C. TAYLOR and W. H. RINKENBACH, *Army Ordnance* **5**, 114 (1925); *Z. ges. Schiess- u. Sprengstoffw.* **20**, 114 (1925).
125. M. STRAUMANIS and A. CIRULIS, *Z. anorg. Chem.* **251**, 315, 332, 335 (1943); **252**, 121 (1943).
126. F. MARTIN, *Über Azide und Fulminate*, Darmstadt, 1913.
127. A. T. THOMAS, unpublished work (1957), according to F. P. BOWDEN and A. D. YOFFE [116].
128. P. GRAY and T. C. WADDINGTON, *27th Intern. Congrès Chimie Industrielle, Brussels*, 1957.
129. S. K. DEB, unpublished work (1957), according to F. P. BOWDEN and A. D. YOFFE [116].
130. W. E. GARNER and D. J. B. MARKE, *J. Chem. Soc.* **1936**, 657.
131. J. MAGGS, *Trans. Faraday Soc.* **35**, 433 (1939).
132. D. J. B. MARKE, *Trans. Faraday Soc.* **33**, 770 (1937).
133. K. SINGH, *Trans. Faraday Soc.* **55**, 124 (1959).
134. S. K. DEB and A. D. YOFFE, *Proc. Roy. Soc. (London) A* **256**, 514 (1960).
135. *Jahresber. Chem.-Techn. Reichsanstalt* **6**, 80 (1927); **8**, 102 (1929).
136. P. W. M. JACOBS, F. C. TOMPKINS and D. A. YOUNG, *Disc. Faraday Soc.* **28**, 234 (1959).
137. H. FICHEROULLE and A. KOVACHE, *Mém. poudres* **33**, 7 (1956).
138. P. L. GÜNTHER, J. PORGER and P. ROSBAUD, *Z. physik. Chem. (B)* **6**, 459 (1930).
139. M. BERTHELOT, *Ann. chim. [6]*, **28**, 138 (1893).

140. M. BERTHELOT and P. VIEILLE, *Bull. soc. chim. France* [3], **11**, 744 (1894).
141. E. WIBERG, *Z. Naturforsch.* **9b**, 495 (1954).
142. C. GRUNDMAN and R. RÄTZ, *Z. Naturforsch.* **10b**, 116 (1955).
143. T. CURTIUS and F. SCHMIDT, *Ber.* **55**, 1571 (1922).
144. H. A. LEHMAN and W. HOLZNAGEL, *Z. anorg. Chem.* **293**, 314 (1958).
145. W. SUNDERMEYER, *Chem. Ber.* **96**, 1293 (1963).
146. T. URBAŃSKI and A. RUSIECKI, *Wiad. Techn. Uzbr.* **26**, 442 (1934).
147. M. O. FORSTER and H. E. FIERZ, *J. Chem. Soc.* **93**, 1867 (1908); M. O. FORSTER and S. H. NEWMAN, *J. Chem. Soc.* **97**, 2573 (1910).
148. T. CURTIUS, *J. prakt. Chem.* **91**, 1, 415 (1915).
149. T. CURTIUS and K. HEIDENREICH, *Ber.* **27**, 2684 (1894); *J. prakt. Chem.* [2], **52**, 472 (1895).
150. A. D. G. FRANCE and R. A. JEFFREYS, *Chemistry & Industry* **1962**, 2065.
151. P. A. S. SMITH, *The Curtius Reaction* in R. ADAMS (Ed.) *Organic Reactions*, Vol. 3, p. 337, J. Wiley, New York, 1946.
152. J. MAI, *Ber.* **24**, 3418 (1891); **25**, 372, 1685 (1892); **26**, 1271 (1893).
153. F. ŠORM, *Chem. Obzor* **14**, 37 (1939).
154. A. PURGOTTI, *Gazz. chim. ital.* **24**, I, 554 (1894).
155. F. SCHRADER, *Ber.* **50**, 777 (1917).
156. A. KORCZYŃSKI and S. NAMYSŁOWSKI, *Bull. soc. chim. France* [4], **35**, 1186 (1924).
157. H. RATHSBURG, Ger. Pat. 341961 (1919).
158. V. V. VASILEVSKII, F. I. BLOKHSHEIN and B. D. KUSTRIA, *Zh. obshch. khim.* **5**, 1652 (1935).
159. O. TUREK, *Chimie et industrie* **26**, 781 (1931).
160. J. H. BOYER, R. S. BURIKS and U. TOGGWEILER, *J. Am. Chem. Soc.* **82**, 2213 (1960); J. H. BOYER and R. S. BURIKS, *ibid.* **82**, 2216 (1960).
161. E. OTT and E. OHSE, *Ber.* **54**, 179 (1921); Ger. Pat. 350564 (1919); *Chem. Zentr.* **1922** II, 1194; Ger. Pat. 355926 (1920); *Chem. Abstr.* **17**, 1242 (1923); U.S. Pat. 1390387 (1921); Brit. Pat. 170359 (1921); *Chem. Zentr.* **1922** II, 1118.
162. H. MURAOUR, *Bull. soc. chim. France* **51**, 1152 (1932).
163. C. TAYLOR and W. H. RINKENBACH, *J. Franklin Inst.* **19b**, 551 (1923).
164. B. GŁOWIAK, *Bull. Acad. Polon. Sci., sér. chim.* **8**, 5 (1960).
165. W. H. SAUNDERS and J. C. WARE, JR., *J. Am. Chem. Soc.* **80**, 3328 (1958).
166. W. T. REICHLE, *Inorg. Chem.* **3**, 402 (1964).
167. J. H. BOYER and F. C. CANTER, *Chem. Rev.* **54**, 1 (1954).
168. P. GRAY, *Quart. Rev.* **17**, 441 (1963).
169. J. E. GOWAN and T. S. WHEELER, *Name Index of Organic Reactions*, Longmans, London, 1960.
170. O. DIMROTH, *Ber.* **35**, 4041 (1902); *Ann.* **399**, 91 (1913).
171. J. H. BOYER *et al.*, *J. Am. Chem. Soc.* **81**, 4671 (1959); *J. Org. Chem.* **25**, 286, 458 (1960).

CHAPTER IV

OTHER INITIATING EXPLOSIVES

DIAZO COMPOUNDS

BERTHELOT and Vieille [1] examined the explosive properties of diazobenzene nitrate $(C_6H_5N=N)^{\oplus}NO_3^{\ominus}$. Later Wöhler and Matter [2] demonstrated that it is unsuitable for use as an initiator due to its very weak initiating properties and very high sensitivity to friction and impact. Herz [3] suggested the use of *m*-nitrodiazobenzene perchlorate. This, however, is hygroscopic and insufficiently stable (it explodes at $154^{\circ}C$).

DINITROBENZENEDIAZO-OXIDE (DINITRODIAZOPHENOL)

The only diazo compound of practical value is dinitrobenzenediazo-oxide (dinitrodiazo-oxide, or less correctly dinitrodiazophenol). In technical literature it may be denoted as DDNP or Dinol.

The following formulae have been ascribed to this substance: cyclic (I) (Bamberger [4]), diazonium (II) (Hantzsch and Davidson [5], Klemenc [6]) or quinonoid (III) (Wolff [7]).

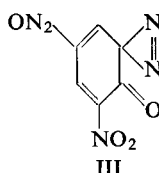
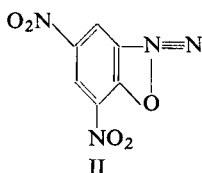
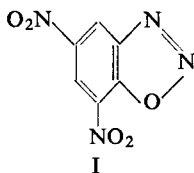

In modern transcription formulae (II) and (III) take the forms (IIa) or (IIIa) (Hodgson and Marsden [8], Anderson and Le Fèvre [9]):

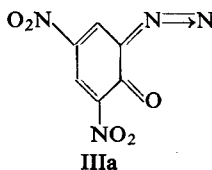
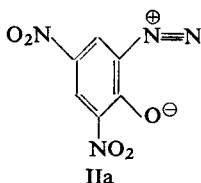

Recently from a comparison of the infra-red absorption spectrum of this compound with that of *o*-benzoquinone Głowiak [10] came to the conclusion that dinitrobenzenediazo-oxide has a quinonoid structure. Both substances show the presence of the strong absorption band of the carbonyl group: 1666 cm^{-1} for dinitrobenzenediazo-oxide and 1680 cm^{-1} for *o*-benzoquinone. In addition dinitrobenzenediazo-oxide gives a band with a frequency of 2190 cm^{-1} , characteristic of a double bond between nitrogen atoms. (Some derivatives of this compound may also have the diazo structure (IIa), which is discussed later on.)

This substance was the first diazo compound to be discovered. It was prepared by Griess [11] by diazotizing picramic acid. Its explosive properties attracted the attention of Lenze [12] who found it to be as valuable as mercury fulminate in spite of its higher sensitiveness to impact. This compound is also of interest as being the first initiator containing no heavy metals. It has now been utilized in the United States of America and Japan as a component of initiating charges in detonators and caps.

Physical properties

Dinitrodiazophenol has a specific gravity of 1.63, and occurs as yellow needles which decompose without melting on heating to 188°C .

Its crystalline form is of great importance from the practical point of view.

The needle-like shape of the crystals prevents their being easily poured (into the capsule) making them liable to felt so the aim is to produce short crystals either by a suitable selection of conditions for the reactions of diazotization and precipitation of the product (D. Smoleński and Pluciński [13]) or by the addition of certain substances to the solution from which the product is to be precipitated; Garfield [14], for instance, suggests for this purpose the addition of triphenylmethane dye-stuffs to the solution.

The physical and explosive properties of dinitrodiazophenol were investigated by Clark [15] and by D. Smoleński and Pluciński [13]. The solubility of dinitrodiazophenol at 50°C (in 100 g of solvent) is: 2.45 g in ethyl acetate, 1.25 g in methyl alcohol, 2.43 g in ethyl alcohol, 0.23 g in benzene, 0.11 g in chloroform.

The substance is also soluble in concentrated hydrochloric acid, acetone, acetic acid, nitrobenzene, aniline, pyridine, and nitroglycerine, at room temperature. In water its solubility is only 0.08% at 25°C .

Chemical and explosive properties

Dinitrodiazophenol is not decomposed by concentrated acids at room temperature, but on the other hand a dilute (e.g. 0.5%) solution of sodium hydroxide causes its decomposition with the evolution of nitrogen even at room temperature. This property finds application in the destruction of residues.

Dinitrodiazophenol is more stable than mercury fulminate. It may be stored without change at 50°C, in dry condition, for 30 months (under these conditions fulminate is stable only for 9 months) and under water for 12 months.

Vaughan and Phillips [16] investigated the decomposition of dinitrodiazophenol at temperatures between 111 and 120°C *in vacuo*. The gaseous products of decomposition contain: 61.5% of N₂, 3% of NO, 4.0% of NO₂, 2.5% of CO, 28% of CO₂. This is evidence of the fact that decomposition consists not only in the loss of diazo group nitrogen, but also in the decomposition of the benzene ring.

Smoleński and Pluciński [13] examined the effect of sunlight and found that signs of decomposition are perceptible after only 40 hr of irradiation. A sample so irradiated shows a somewhat lower ignition temperature.

Kaufman [17] found that γ -radiation produces gas evolution from dinitrodiazophenol. Partial decomposition occurred after 45 days of irradiation (on average 10⁵ r per hour) and the explosive power of the irradiated substance was reduced and irregular.

Dinitrodiazophenol explodes [13] on a metal plate at 180°C after 10 sec; at 185°C after 5 sec; at 190°C after 2.5 sec; at 200°C after 1 sec.

In spite of its high specific gravity the apparent density of the needle-shaped crystals, according to Clark [15], is only 0.27; under a pressure of 240 kg/cm² it is 0.86. The crystals may be obtained in the form of pellets whose apparent density is about 0.8. The effect of the conditions of preparation have been thoroughly examined by Smoleński and Pluciński [13]. They found that at a diazotization temperature as recommended by Clark, i.e. 15°C, the product pours with difficulty. Conversely, diazotization at a higher temperature (25–45°C) results in formation of a product with a density of about 0.82.

Smoleński and Pluciński prepared dinitrodiazophenol in the form of free-flowing crystals by applying the following reaction conditions:

A solution of 320 g of sodium nitrite in 2 l. of water is added to a suspension of 1000 g of the sodium salt of picramic acid in 8 l. of water. Next, 6 l. of 5.5% hydrochloric acid is added dropwise for 2 hr, stirring continuously. The initial temperature of 20°C rises to 25°C. Completion of the reaction is determined by means of starch–iodide paper. The product is filtered off, washed with cold water and dried at 35–40°C. Its yield amounts to 80% of the theoretical.

T. Urbański, Szyk-Lewańska *et al.* [18] have recently found that dinitrobenzene-diazo-oxide can be prepared by oxidation of picramic acid with chromium trioxide in the presence of sulphuric acid at 55–60°C. One part of picramic acid is fully oxidized by chromic acid to yield gaseous products: CO, CO₂, NO₂, NH₃ and H₂O. Nitrogen dioxide acts further as a diazotizing agent on undecomposed picramic acid to yield the diazo compound. The yield of this reaction does not exceed 31% of theoretical calculated on the picramic acid used.

Clark confirmed that dinitrodiazophenol does not become “dead pressed” even under a pressure of 9140 kg/cm² which is a great advantage in an initiating material. Smoleński and Pluciński quote the following figures which are characteristic of its

explosive properties. The substance is endothermic. Its heat of formation is about 365 kcal/kg. The reaction proceeds according to the following equation:

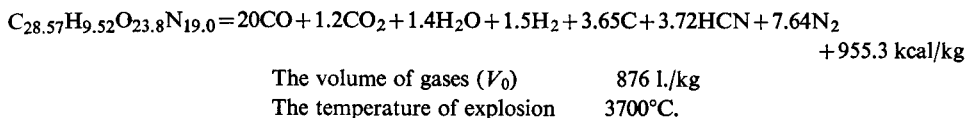

Owing to the great volume of gases, high heat of formation and high explosion temperature this substance is a much stronger explosive than those initiators which contain metal in the molecule.

According to Clark [15] 1 g of dinitrodiazophenol on being pressed at a pressure of 240 kg/cm² into a copper capsule gives an expansion of 25 cm³ in a small lead block (mercury fulminate 8 cm³, lead azide 7 cm³). Using 0.75 g of the substance, Smoleński and Pluciński obtained a lead block expansion of 17–23 cm³.

Clark found dinitrodiazophenol less sensitive to impact than mercury fulminate, lead azide or lead styphnate; it is exploded by a drop of 375 g weight from a height of 22.5 cm, whereas mercury fulminate is exploded by a drop of 15 cm.

Smoleński and Pluciński also disclosed that a fine crystalline product is more sensitive (15 cm drop) and coarse crystalline less sensitive (30 cm drop).

A. Belayev and A. Belayeva [19] found its linear rate of burning to be 2.15 cm/sec.

The initiating properties of dinitrodiazophenol were investigated by Clark [15] and Smoleński and Pluciński [13]. According to Clark the initiating power of the substance is approximately twice as great as that of mercury fulminate, but a little less than that of lead azide.

Thus to initiate picric acid the following quantities of priming explosives are required:

0.115 g of dinitrodiazophenol
0.225 g of mercury fulminate
0.12 g of lead azide

For trinitrotoluene the corresponding figures are as follows:

0.163 g, 0.240 g, 0.16 g

and for tetryl:

0.075 g, 0.165 g, 0.03 g.

In Smoleński and Pluciński's opinion dinitrodiazophenol alone is not suitable as an initiating material for detonators since it requires too long a path for burning to change into detonation, hence it is necessary to add another initiating substance e.g. lead azide. Nevertheless it is suitable for filling caps.

The properties of benzenediazo-oxides

Vaughan and Phillips [16] studied the decomposition of 4-diazo-1-oxide (III) and nitro derivatives of this compound (IV, V) and of the nitro derivatives of 2-diazo-1-oxide (VI, VII, VIII).

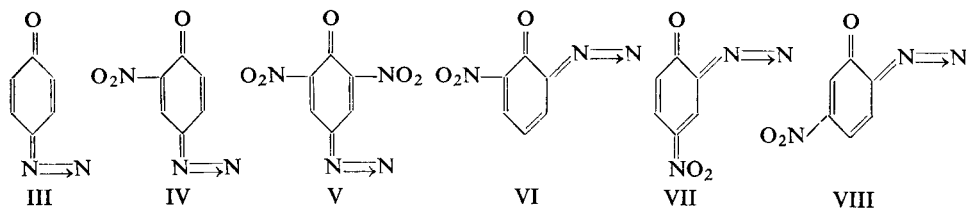

Their experiments showed that the nitro derivatives of 4-diazo-1-oxide are more stable than the corresponding derivatives of 2-diazo-1-oxide.

The introduction of a nitro group at the *ortho*-position to the oxygen atom in 4-diazo-1-oxide (IV) increases the stability. Great stability is also demonstrated by the *o*- and *p*-substituted nitro derivatives of 2-diazo-1-oxide (VI and VII). On the other hand, the *m*-substituted compound (VIII) has a lower stability than compounds (VI) and (VII). Dinitro substituted derivatives, *ortho-ortho* (V) and *ortho-para* (IIa), are distinguished by a higher stability than the mononitro derivatives of the same oxides (IV) or (VI) and (VII).

Głowiak [20] examined the properties of the diazotization products of numerous nitro derivatives of *o*-aminophenol, viz.:

2,6-dinitro-4-amino-*m*-cresol
 4,6-dinitro-2-amino resorcinol
 5-nitro-3-aminosalicylic acid
 4,6-dinitro-2-amino-*m*-hydroxybenzoic acid.

From them he prepared the diazo compounds (IX), (X), (XI), and (XII).

From their infra-red absorption spectra he ascribes a quinonoid structure to the first two compounds and a diazo structure to the last two and to their plumbous salts:

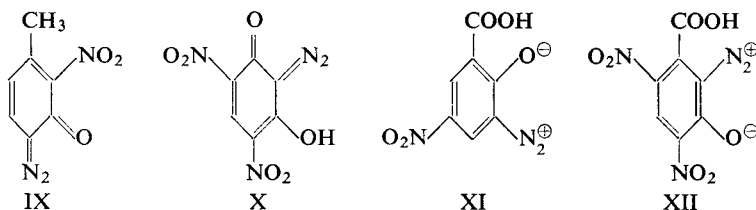

The compounds with a quinonoid structure differ from those with a diazo structure by their darker colour and lower chemical stability. They are for example easily decomposed by light and concentrated acids; they are less resistant to heat and show a higher sensitiveness to impact, friction and flame than compounds with a diazo structure.

Phenyldiazonium nitroformate. Nitroform derivative (XIII) is of particular interest among derivative diazonium salts. It was prepared by Ponzio [21] who reacted the potassium salt of trinitromethane (nitroform) with an aqueous solution of phenyldiazonium acetate:

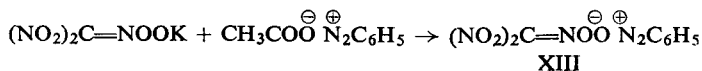

Quilico [22] questioned the formula (XII), assuming the substance to be an azo compound with the structure $(\text{NO}_2)_3\text{C}-\text{N}=\text{NAr}$, but in a later paper Ponzio [23] insists that in principle his formula is correct, while modifying it into $(\text{NO}_2)_3\text{CN}_2\text{C}_6\text{H}_5$ (XIIIa).

On the basis of its infra-red absorption spectrum Głowiak [20] deduced an ionic structure (XIIIb), confirming, in principle, the formula (XIIIa):

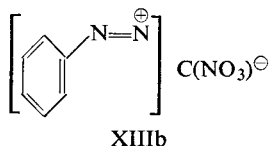

According to Głowiak's researches this substance has the following properties. Its ignition temperature with an induction period of 1 sec is 124°C . To initiate 0.5 g of tetryl, compressed under a pressure of 500 kg/cm^2 , the minimum charge of the phenyl diazotate of nitroform, loosely poured or compressed under a pressure of 100 kg/cm^2 , is 0.3 g. When compressed at higher pressure (300 kg/cm^2) the charge must be increased to 0.5 g.

Dinitrobenzene diazo-oxide reacts with hydrazine hydrate to yield 2,4-dinitro-6-[tetrazene-(1)]-phenolhydrazine salt (XIV)

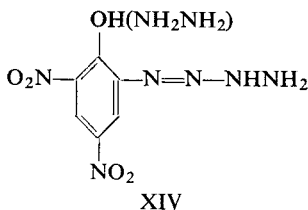

The product (XIV) can form metal salts. Some of them (e.g. potassium salt) possess initiating properties [24].

THE DERIVATIVES OF AMINOGUANIDINE

TETRAZENE

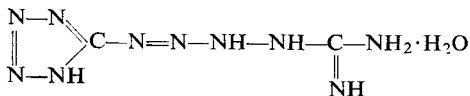

Tetrazene or tetrazolylguanilyltetrazene hydrate was first prepared by Hoffmann and Roth [25], by the action of a neutral solution of sodium nitrite on aminoguanidine salts (without an excess of inorganic acid). According to these authors the reaction proceeds as follows:

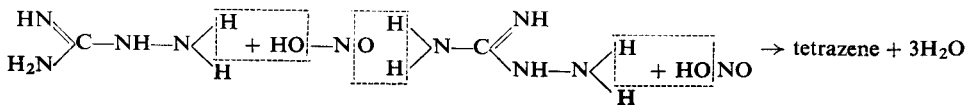

Substance (VI) reacts in an enol form (VIa):

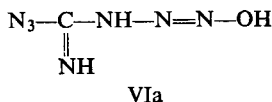

On the addition of copper acetate to a solution of compound (VI) the copper salt (VII) is formed which on treatment with acid decomposes to form 5-azido-tetrazole (VIII):

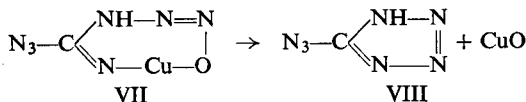

Tetrazene is stable at temperatures up to 75°C. At 100°C it undergoes marked decomposition. The ignition temperature of tetrazene is lower than that of mercury fulminate. On a metal plate, heated to 160°C, it explodes after 5 sec (mercury fulminate behaves in the same way at 190°C). According to Wallbaum [29] tetrazene explodes at 140°C on being heated at the rate of 20°C/min.

The explosion heat of tetrazene is rather low, i.e. 663 kcal/kg. This is characteristic of explosive substances containing a guanyl group in the molecule.

According to some authors tetrazene is rather more sensitive to impact than mercury fulminate. Others consider it to be equally sensitive.

The ease with which tetrazene is detonated by ignition depends to an exceptionally great extent on its density. It has been shown that tetrazene detonates most easily when it is poured freely into the capsule; when pressed it gives a much weaker detonation. Rinkenbach and Burton [30] obtained the following data in a sand test, using a 0.4 g charge of tetrazene:

TABLE 37

Tetrazene charge pressed under a pressure of kg/cm ²	Crushed sand, g
0	13.1
16.7	9.2
33	7.5
200	2.0

Thus, at a pressure of 200 kg/cm² the substance nears the condition of being "dead pressed". In spite of the fact that burning under this condition passes to detonation with difficulty, when greatly compressed the material maintains its ability to be detonated by a cap. Thus, 0.4 g of tetrazene, pressed under a pressure of 200 kg/cm², develops its maximum power, i.e. 21.1 g of sand crushed, when initiated with 0.4 g of mercury fulminate. The difficulty in passing from burning to detonation makes tetrazene unsuitable for detonators and its application is thus limited to

ignition caps, where even 2% in the composition results in improved uniformity of percussion and friction sensitiveness and makes it suitable as a sensitizer for friction compositions.

The explosive properties of tetrazene perchlorate are also of interest.

Tetrazene manufacture

In the Wolfratshausen factory [31] in Germany, an 8% solution of sodium nitrite and a 12.5% solution of aminoguanidine sulphate, slightly acidified with acetic acid in the presence of litmus, were used for the reaction.

Into a reactor of the type used for the manufacture of lead azide (cf. Fig. 49) 50 l. of a solution of sodium nitrite (4 kg of NaNO_2) were introduced and heated to a temperature of 50–55°C. To the warm solution 40 l. of a solution of aminoguanidine sulphate, containing 5 kg of the dry substance, was added during a period of 1–2 hr. The rate at which the solution was introduced influences the dimensions of the crystals formed. If the solution was introduced rapidly, small crystals resulted, if it was introduced slowly, the crystals were large.

In some factories (e.g. at Stadeln [32]) dextrin was added to the reacting solutions to obtain more uniform crystals. After a solution of aminoguanidine sulphate has been added, the contents of the reactor were stirred for a further 30 min, when the stirrer was stopped. The precipitate of tetrazene settled on the bottom, the liquid from above the precipitate was decanted, the precipitate itself was covered with water, agitated, allowed to stand, decanted and finally transferred by a powerful stream of water onto a cloth filter. The product was washed first on the filter with water and finally with alcohol. The tetrazene, containing alcohol, was then transferred in a bakelite vessel together with the filter. Washing with alcohol is necessary for uniform drying of the product. If tetrazene containing only water is dried, the crystals are liable to stick together due to the low solubility of tetrazene in water. The presence of alcohol completely prevents this. Tetrazene was dried in the usual way (cf. p. 155) at a temperature from 45 to 55°C.

From the above-quoted amounts of raw material 2.6–2.7 kg of product is obtained.

The waste tetrazene, collected in settling tanks (vessels), is destroyed by injection of live steam.

Other reactions of aminoguanidine with nitrous acid

During the reaction of tetrazene preparation care should be taken that the solution contains neither free inorganic acid nor an excess of acetic acid.

When guanidine sulphate is treated with sodium nitrite, a molecule of sulphuric acid combined with guanidine is sufficient for the liberation of nitrous acid from sodium nitrite in an amount necessary for the reaction.

In the presence of an excess of inorganic acid, the reaction proceeds differently and the formation of azidoguanidine (IV) as a final product takes place

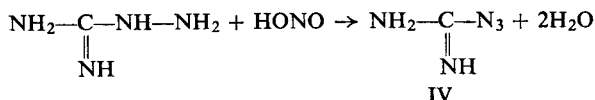

This substance forms salts with acids. The nitrate, perchlorate and picrate of (IV) have explosive but not initiating properties.

Azidoguanidine is not decomposed by boiling in water. It is, however, hydrolysed on treatment with concentrated sodium hydroxide to form sodium azide. Under the influence of a dilute solution of sodium hydroxide or of dilute acids it is isomerized to 5-aminotetrazole (V):

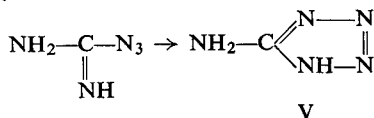

Attempts have been made to employ aminotetrazole as a constituent of smokeless and flashless propellants.

The reaction of aminoguanidine with nitrous acid in the presence of an excess of acetic acid gives also 1,3-ditetrazyltriazine (IX). It is possible that 5-aminotetrazole first arises, which then undergoes diazotization and the diazo compound thus formed couples with the remaining aminotetrazole:

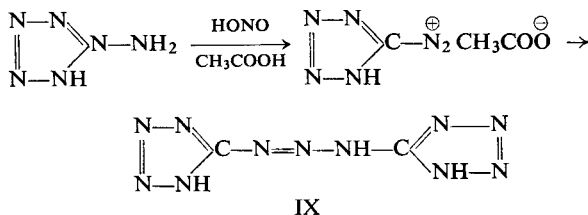

NITROSOGUANIDINE

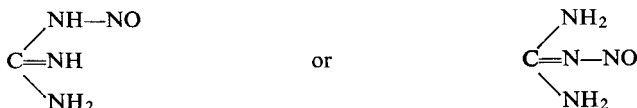

Davis and Rosenquist [33] suggested the use of nitrosoguanidine as a weak initiator. This compound occurs in the form of pale yellow crystals which explode on being heated to 165°C.

According to these authors, nitrosoguanidine is prepared by the reduction of nitroguanidine with zinc dust in a neutral medium, in the presence of ammonium chloride at room temperature (below 20–25°C). The product is filtered off together with a precipitate of zinc oxide and zinc salt, from which it is then extracted with hot (65°C) water. Nitrosoguanidine crystallizes when the solution is cooled to 0°C. The yield is about 50%.

Nitrosoguanidine decomposes explosively on contact with sulphuric acid. When dry, it is very stable, but it decomposes in the presence of water and in a moist atmosphere. Its lack of stability prevents its practical application.

CYANAMIDE SALTS

Silver cyanamide

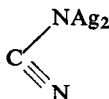

Chretien and Woringer [34] described the preparation of silver cyanamide from calcium cyanamide by the action of silver nitrate and also described its explosive properties. Montagu-Pollock [35] described a method for growing large crystals of the salt from its aqueous solution in the presence of ammonium nitrate, ammonia and a surface active agent. Bowden and Montagu-Pollock [36] and Montagu-Pollock [35] studied the slow decomposition of the crystals when heated at temperatures from 150 to 360°C. The course of decomposition was studied by electron microscope.

The main conclusions from this work were:

- (1) Nucleation by metallic decomposition products was observed only in the special cases involving the initiation of holes of crystallographic shape.
- (2) In general, decomposition was found occurring everywhere on the crystal surface.
- (3) The silver produced by the decomposition was very mobile on the crystal surface.
- (4) Boundaries appeared separating areas of greater and lesser decomposition.

NITROCYANAMIDE SALTS

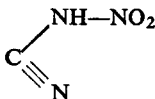

The explosive properties of the potassium salt of nitrocyanamide first attracted McKay's [37] attention. He separated this potassium salt as a by-product from the preparation of aliphatic diazo compounds by the hydrolysis of N-alkyl-N-nitroso-N'-nitroguanidines with an aqueous solution of sodium hydroxide at temperatures from 0°C to room temperature:

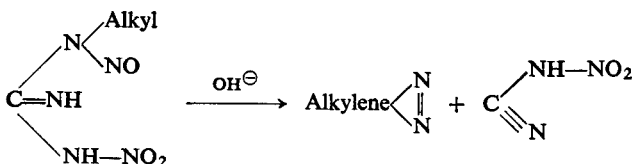

The same author *et al.* (McKay, Hatton, G. W. Taylor [38]) prepared a number of nitrocyamide salts by the action of the chlorides of various metals on the silver salt in suitable solvents or the by reaction of the carbonates of various metals with a solution of nitrocyamide in acetonitrile, and found that some of these salts have initiating properties. The majority, however, cannot be recommended for practical use, their sensitiveness to impact being too low (they are not exploded by a 5 kg weight falling from a height of 300 cm).

Harris [39] reports that only the following nitrocyamide salts possess greater sensitiveness and may be considered to be of practical use: potassium, tin, lead, barium and silver nitrocyamides.

Comparing with the experiments of Grant and Tiffany [40] Harris states that silver and barium nitrocyamides show an initiation capacity the same as that of an 80 : 20 mixture of mercury fulminate and potassium chlorate, but weaker than that of a mixture of lead azide and lead styphnate. This can be seen from Table 38 quoted by Harris:

TABLE 38

Primary explosive	Minimum initiating charge necessary for explosion of 1.25 g of tetryl	Sand crushed per g
Lead azide-lead styphnate (80 : 20)	0.15	110
Diazodinitrophenol-potassium chlorate (75 : 25)	0.25	103
Mercury fulminate-potassium chlorate (80 : 20)	0.40	83
Silver nitrocyamide	0.45	91
Barium nitrocyamide	0.50	80

In spite of their fairly promising initiating properties, nitrocyamide salts are of no practical use due to their high hygroscopicity.

For instance, due to its hygroscopicity, the air-dried tetrahydrated lead salt is not exploded by a 5 kg weight falling 325 cm. Only after being dried over magnesium perchlorate it is exploded with 100% probability by a 15 cm drop, whereas the anhydrous lead salt is exploded by a 10 cm drop.

NITROPHENOL SALTS

LEAD PICRATE

A number of salts of picric acid have been described already (Vol. I). Some salts of polynitrophenols and of heavy metals have initiating properties. One of the earliest known substances of this kind is lead picrate. Its high sensitiveness to the action of mechanical impact, however, raised difficulties in its practical utilization.

T. Urbański and Kruszyńska [41] made a comparative study of the sensitiveness to impact of lead picrate and other initiating explosives. They found lead picrate to be more sensitive than any other substance. They also examined the decomposition of lead picrate on hot metal plates. On contact with a metal surface heated to 341°C it explodes after 3 sec, and on one heated to 370°C after 1 sec.

From their results the authors calculated the activation energy of the thermal decomposition which leads to explosion of this substance, and obtained a value of 55.6 kcal/mole.

During World War II the Germans employed, on a small scale, cap compositions containing lead picrate for the manufacture of electric fuses giving few gaseous products.

The lead picrate for this purpose was produced in the following way [42]. Into a stainless-steel reactor equipped with a stirrer of the type used for the manufacture of lead azide and other initiators (cf. Fig. 49) 8 l. of a solution containing 1.44 kg of lead nitrate and 15 l. of ice water were poured. Fifteen litres of a solution containing 1.5 kg of picric acid were then added. During the reaction the temperature should be maintained between 6 and 10°C. Since the temperature rises with the precipitation of lead picrate, 7–8 more litres of ice water must be poured into the reactor, usually a few minutes after the picrate has begun to precipitate. After 4 hr the liquid was decanted from above the precipitate; the latter was transferred to a cloth filter and washed with alcohol (10 l.) to which an aqueous solution of lead nitrate (500 ml of a 30% solution) has been added to avoid the dissolution of lead picrate during washing. 2.2 kg of product was obtainable from one batch.

The very fine crystalline precipitate of lead picrate which with water takes the form of a paste, was then dried for 4 days, first at 40°C and finally at 60°C. The product so dried was sieved through a silk screen of 600 mesh per cm². The lead picrate was then mixed with silicon and lead chromate.

LEAD STYPHNATE

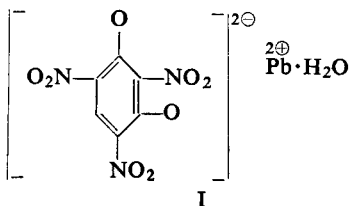

Lead trinitroresorcinate or lead styphnate is also known under the names: Bleitrizinat, Trizinat in Germany and Teneres in the U.S.S.R.

It is usually prepared by adding a solution of lead nitrate to one of magnesium styphnate. The latter is an easily soluble and weakly basic salt of trinitroresorcinate. The use of suitable salts and conditions (pH, temperature, rate and sequence in adding the raw materials) is of great importance, since unsuitable salts and condi-

tions may easily lead to the formation of basic lead styphnate, which has considerably weaker initiating properties.

The basic salt is formed by the reaction of lead acetate with sodium or magnesium styphnate. The chemical composition of the basic salts formed depends upon the reaction conditions. The basic salt is usually credited with the structural formula (II), corresponding to the dibasic salt:

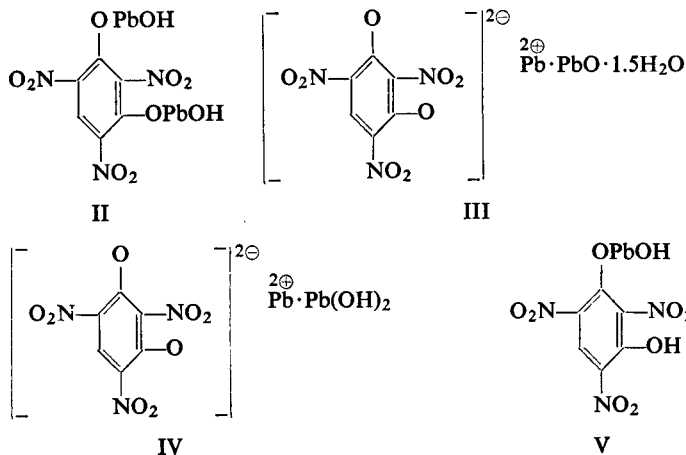

Griess [43], who possibly dealt with the same salt, ascribed to it the structure III.

According to Zingaro [44] the dibasic salt (II) may be prepared by slowly adding a solution of styphnate in a 2% solution of sodium hydroxide at 65–70°C to an aqueous solution of lead nitrate. Zingaro also reports that structure (IV) is possible for this salt.

Finally there is the possibility of the formation of monobasic salt, probably with the structure (V). Basic salts may be converted into neutral ones by the carefully controlled action of nitric acid.

The neutral salt has a characteristic reddish-brown colour, whereas the basic salts are yellow.

Lead styphnate (neutral salt I) is practically insoluble in water (0.04 g in 100 ml of water, at 15°C) and in the majority of organic solvents. It is very stable at room and elevated temperatures (e.g. 75°C) and is not hygroscopic. In a moist atmosphere, at room temperature, it absorbs only 0.05% of water. Its specific gravity is 3.1, its apparent density, 1.0–1.6.

A method of preparation of the neutral salt (I) has been given by Herz [45]. He claims that the anhydrous salt crystallizes from an aqueous solution. In the light of other authors' works (e.g. Zingaro), it is doubtful whether in such conditions, an anhydrous salt can really be formed. The dehydration of neutral lead styphnate (I) was investigated by Zingaro who found that complete dehydration may be effected by heating the substance at 115°C for 16 hr. At higher temperatures (135–145°C) dehydration takes place more quickly (Fig. 53). Stettbacher [46] reported that in a moist atmosphere anhydrous lead styphnate absorbs water to reform

the hydrate. This observation was confirmed by Zingaro [44]. The hydration curve at 30°C, according to Zingaro, is represented in Fig. 53.

Zingaro has also shown that the neutral lead styphnate, which is orange in colour, reacts with pyridine at 50°C, to form pale yellow needles after approximately 1 hr. This is a molecular addition product of $\frac{1}{2}$ pyridine molecule to 1 mol. of basic lead styphnate:



The neutral salt crystallizes with one molecule of water (according to some authors, e.g. Rinckenbach [47]), or with half a molecule of water, which exerts a favourable influence on the substance's sensitiveness to impact. This sensitiveness is relatively

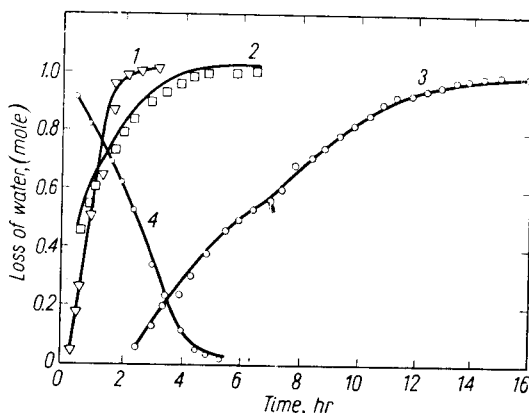

FIG. 53. Loss of water of crystallization by the neutral salt of lead styphnate at various temperatures: 1—145°C, 2—135°C, 3—115°C, 4—hydration curve at 30°C, according to Zingaro [44].

small. Wallbaum [29] reports a drop test figure of 23 cm for a 1 kg weight, whereas mercury fulminate is exploded by an 8–10 cm drop and the corresponding figure for lead azide is 23 cm.

Research by T. Urbański and Kruszyńska [41] showed that lead styphnate (neutral salt) is exploded in the drop test by a 2 kg weight performing work of 5.0 kgm/cm², whereas lead picrate is exploded by work of 0.04 kgm/cm².

The ignition temperature of lead styphnate is 267–268°C.

A number of authors have investigated the thermal decomposition of lead styphnate: Hailes [48] examined the decomposition of this substance within the temperature range 200 to 228°C, and Garner, Gomm and Hailes [49] derived the following equation for the decomposition curve:

$$p = ct^m \quad \text{where}$$

p — pressure developed by the decomposition products,

c — constant,

t — temperature,

m — exponent with values ranging from 0.88 to 4.43.

Tompkins and Young [50] investigated the decomposition of the substance at temperatures between 195 and 229°C. Explosive decomposition begins at a temperature above 235°C. Decomposition curves as a function of time at various temperatures are reproduced in Fig. 54, the kinetic equation taking the form:

$$p = k(\tau - \tau_0)^2 \quad \text{where}$$

p — pressure developed by the decomposition products,

k — the rate constant,

τ — time,

τ_0 — time of about 10 min, denoting the end of the process.

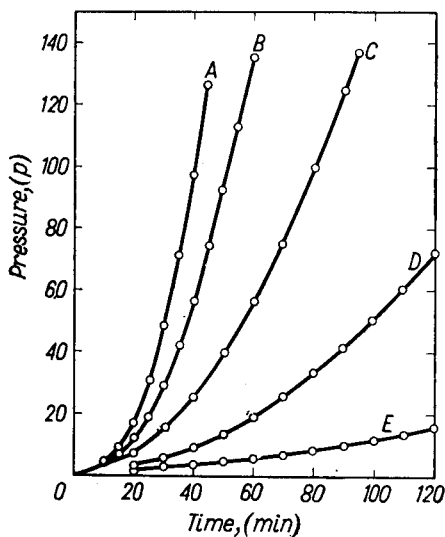

FIG. 54. The decomposition of lead styphnate monohydrate. Pressure developed with time at various temperatures: *A*— at 229.3°C, *B*—at 224.4°C, *C*—at 216.9°C, *D*—at 214.5°C, *E*—at 194.9°C, according to Tompkins and Young [50].

The activation energy of decomposition, according to Hailes, is 46.7 kcal/mole, according to Tompkins and Young 33 kcal/mole and according to T. Urbański and Kruszyńska [41] 42.2 kcal/mole.

Tompkins and Young confirmed Zingaro's [44] figure for the activation energy of the dehydration of lead styphnate as 13 kcal/mole.

The inflexion in curves (*A*) and (*B*) occurs after a decomposition of about 30% of substance. The plots of the acceleratory period are approximately parabolic. The mechanism of the decomposition probably consists of nucleation of sub-grains at the edges and progression of the reaction into the grains with a non-coherent interface.

Evans and Yuill [51] showed that lead styphnate may be ignited by adiabatic compression of air, the calculated temperature amounting to 660°C, whereas Bryan

and Noonan [52] using helium as the gas surrounding the styphnate, found that the energy to obtain the necessary compression for igniting this substance is 0.046 cal/cm².

McAuslan [53] examined the ignition of lead styphnate by irradiation with the intense light of a spark from an electric discharge. The light energy required to initiate lead styphnate to explosion was 29 J. This author also studied the relationship between the light energy required to initiate lead styphnate and the temperature

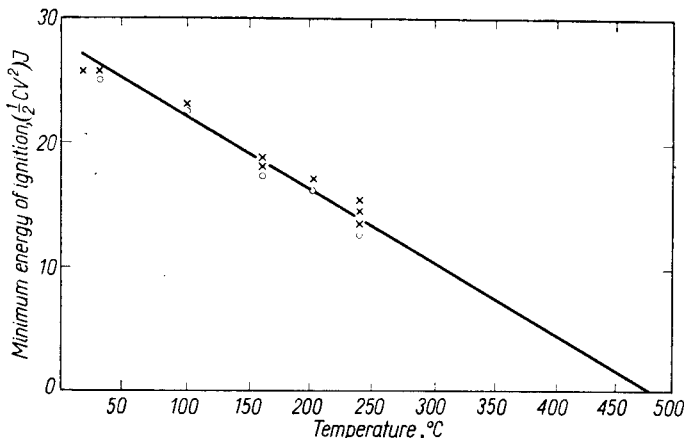

FIG. 55. Variation of the minimum light energy for ignition of lead styphnate with ambient temperature, according to McAuslan [53]. ×—ignition; ○—no ignition.

of the substance. He obtained a straight line graph (Fig. 55). Extrapolation gives a temperature of 480°C for zero light energy. This value is higher than the ignition temperature of non irradiated lead styphnate.

Kaufman [17] found lead styphnate to be exceptionally resistant towards nuclear radiation. After 90 days strong γ -radiation from ¹⁹⁸Au (an average irradiation of 10⁵r per hour) produced practically no change in the substance. The volume of gas evolved after 90 days was only 0.12 ml/g.

High ignitability by direct action of a flame or electric spark is a characteristic feature of lead styphnate. The salts enormous sensitiveness to the discharge of static electricity was first disclosed in 1938 by Barcikowski, Dobrzyński and Kielczewski [54].

This property has since been confirmed by many authors (Hartmann, Nagy and Brown [55]; Morris [56]; and Taylor and Hall [57]). It became clear that numerous accidents due to the ignition of lead styphnate during drying, pouring, moving, stirring etc. had been caused by the discharge of accumulated static electricity. Attempts to reduce its sensitiveness by the addition of graphite have been unsuccessful, and lead styphnate continues to be very dangerous to handle.

Special attention is now paid to the careful earthing of all parts of the plant in which dry lead styphnate is handled. Floors in factory buildings should be made

of asphalt or of a soft material (plastic) containing graphite or aluminium to make them conduct electricity. When manual work with lead styphnate is unavoidable, the operator should stand on a felt-cloth sheet saturated with a solution of calcium chloride.

To prevent excessive dryness of the working atmosphere, which favours the build up of static electricity, wet cloths should be hung about the building or air-humidifying equipment used.

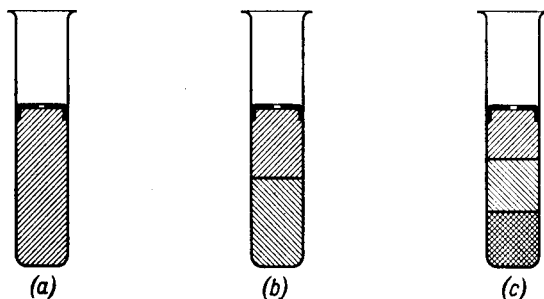

FIG. 56. Blasting caps: (a)—charged with a single explosive (mercury fulminate or lead azide); (b)—charged with a primary explosive and a high explosive; (c)—charged with three layers: a primary explosive and two high explosives.

A more modern procedure is to introduce by means of radioactive salts ionized air into the premises.

Lead styphnate is a fairly weak explosive because of its high metal content (44.25%).

The rate of detonation is:

at a density of 0.93	2100 m/sec
at a density of 2.6	4900 m/sec
at a density of 2.9	5200 m/sec

It is also very weak as a primary explosive. Even 1.0 g of it fails to initiate penthrite compressed under a pressure of 2000 kg/cm². It is therefore not used for filling detonators, and its applications are limited to use in

(a) non-corrosive ignition caps (so called "Sinoxyd");

(b) addition to lead azide in detonators to facilitate ignition;

and (c) as a covering layer to protect lead azide against carbon dioxide and to facilitate ignition (Fig. 56).

Lead styphnate manufacture

In the method employed at Wolfratshausen [31] a solution of magnesium styphnate was first prepared, adding to 20 kg of magnesium oxide a suspension (partly solution) of 120 kg of trinitroresorcinol in 350 l. of water. The temperature rose

spontaneously due to the reaction, but should be raised further by heating to 60°C. The solution so obtained was filtered through a cloth filter, diluted with water to s.g. 1.043 (6°Bé) and poured into a vat, in which it was allowed to stand for 10 hr. The temperature then fell to 25–30°C.

From the magnesium styphnate solution so prepared, 86.4 l. of liquid was decanted, leaving the lower layer in which the sediment was collected. This solution was heated to 60°C, while stirring, and 22.7 l. of 34% solution of lead nitrate, s.g. 1.274 (31°Bé) was then poured into it during a period of 20–30 min, while stirring continued and the temperature was maintained at 60°C. When the solutions were mixed, the contents of the reactor were cooled as quickly as possible to 25°C; when this temperature has been reached the stirrer was stopped and the precipitated sediment of lead styphnate was allowed to settle. The liquid from above the sediment was then decanted, and the latter was first washed out of the reactor by a stream of water, and transferred onto a cloth filter, where it was washed again as is the custom with other primary explosives. From the above mentioned amounts of raw material about 8 kg of lead azide was obtained.

The product was dried in a drier (as described for mercury fulminate) at temperatures from 65 to 70°C in batches of 1.2 kg at a time; it was then sieved as described above. A sieve analysis of the product showed, for example, the following sizes of crystals:

on sieves with a clearance of 0.1 mm	8% of the substance was retained
on sieves with a clearance of 0.075 mm	33% of the substance was retained
on sieves with a clearance of 0.060 mm	32% of the substance was retained
on sieves with a clearance of 0.040 mm	18% of the substance was retained
and	9% of the substance passed through.

Waste lead styphnate was destroyed by adding an excess of sodium carbonate; most of the lead was then precipitated as a carbonate and a solution of sodium styphnate was formed. This solution was then treated with iron filings and acidified with sulphuric acid, reduction of the nitro groups took place, and the substance ceased to be dangerous.

The continuous method for the manufacture of lead styphnate (according to Meissner [58, 59])

The continuous preparation of lead styphnate can be carried out in the same equipment as for the manufacture of lead azide (Fig. 50) after previous cleaning of the apparatus and exchanging the flowmeters.

For this production, the starting materials are needed: trinitroresorcinol and magnesium oxide to form magnesium styphnate and lead nitrate, all dissolved in distilled water.

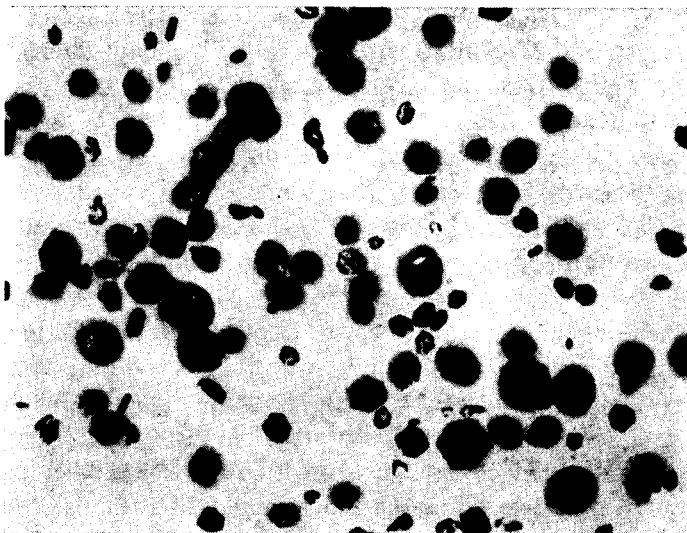

FIG. 57. Lead styphnate precipitated by Meissner method [59]. Courtesy J. Meissner.

The precipitating temperature is, in this production, somewhat higher than in the manufacture of technical-grade lead azide.

All other operations are similar to those already described before.

Lead styphnate crystals obtained by this method are sphere-shaped (Fig. 57).

OTHER STYPHNATES

Tompkins and Young [50] examined the thermal decomposition of barium styphnate and found it to be similar to that of lead styphnate hydrate (Fig. 54).

The point of inflexion of the decomposition curve occurs after 50% of the substance has decomposed. The energy of decomposition is 36.5 kcal/mole.

According to T. Urbański and Kruszyńska [41] thallium styphnate has similar properties to those of lead styphnate. The former, however, is much more sensitive to impact than the latter. Their sensitiveness to temperature is similar: contact with a metal surface heated to 351°C causes explosion after 1 sec. The activation energy of thermal decomposition is nearly 80 kcal/mole.

LEAD DINITRORESORCINATE

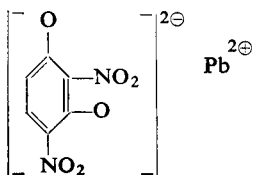

This substance is prepared by the action of a hot solution of lead nitrate on a solution of sodium dinitroresorcinate. The lead salt is precipitated as the solution cools. Lead dinitroresorcinate ignites from a direct flame readily and burns with great velocity. Its initiating action is weaker than that of lead styphnate and it is less sensitive to impact and friction than styphnate. It has therefore recently found application as a component of cap compositions. It is valuable because it is safer to handle than styphnate. The preparation of dinitroresorcinol is discussed in Vol. I, p. 536.

NITROSOPHENOL SALTS

Nitrosophenols are formed very easily by the action of nitrous acid on phenols. Some salts of heavy metals have weak initiating properties. These are: lead dinitrosophenate and lead trinitrosophloroglucinate.

Due to the readiness with which it ignites under the direct influence of flame, lead dinitrosophenate has found a certain application in the manufacture of cap compositions for ignition by spark or flame. Its disadvantage lies in its relatively low stability; heating to 120°C causes explosion after 2 hr, and after 10 days of heating at 80°C marked decomposition occurs.

NITRAMINE SALTS

T. Urbański, Piskorz and Mazur [60] prepared a number of methylenedinitramine salts

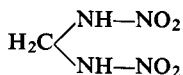

and found that the silver and lead salts have initiating properties. Their ignition temperatures and sensitiveness to impact are shown in the following table:

TABLE 39

Salt	Ignition temperature	50% of explosions by 2 kg weight dropped from
Silver	195°C	10 cm
Plumbous	213°C	12 cm

"ISONITRAMINE" (NITROSOHYDROXYLAMINE) SALTS

T. Urbański, Zacharewicz and Pietrzyk [61] suggested the use of some methylenedi-isonitramine salts $(\text{CH}_2)(\text{N}_2\text{O}_2\text{H})_2$ as primary explosives.

The sodium salt of methylenedi-isonitramine was prepared by Traube [62] from acetone and nitric oxide in the presence of sodium alcoholate according to the following chain of reactions:

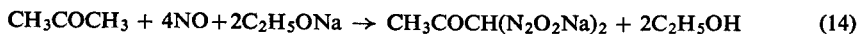

Product (I) so produced undergoes hydrolysis in water:

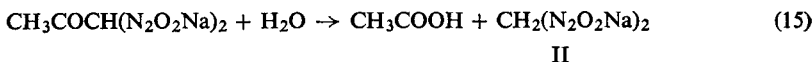

The sodium salt of methylenedi-isonitramine (II) is formed. In an aqueous solution this precipitates with the salts of heavy metals. Some of these salts (e.g. the thallium salt) have the properties of weak initiators.

The structure of these compounds remained obscure for a long time. Traube originally assigned the structure —N—N—OH to the isonitramino group, but in further researches he found that isonitramines and the derivatives of nitrosohydroxylamine which he prepared by the action of nitrous acid on β -derivatives of hydroxylamine were identical. He did not, however, draw from this any definite conclusions as to the structure of isonitramines in spite of the fact that by the synthesis of isonitraminoisobutyric acid, Gomberg [63] had confirmed the nitrosohydroxylamine structure of the isonitramino group.

Hantzsch [64] described isonitramines as compounds which have either the structure reported by Traube (I) or that of nitrosohydroxylamine (IIa):

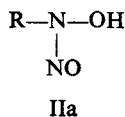
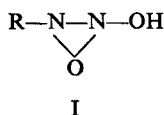

for which the tautomeric formula (IIb) is also possible:

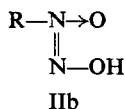

Hantzsch expressed the opinion that the active hydrogen in isonitramines is always combined with the oxygen atom whereas in nitramines it may be combined, in different tautomeric modifications, either with the nitrogen or the oxygen atom.

In the light of Angeli's [65] investigations, which led to the conclusion that the azoxy group has an unsymmetrical structure (—N=O—), and not as formerly



assumed the symmetrical one of (—N=N—), it did not seem possible to accept a



symmetrical structure for the isonitramine group (I).

Hantzsch and Strasser [66] came to this conclusion and assigned the structure of nitrobenzyl-N-nitrosohydroxylamine to esters of nitrobenzylisonitramine:

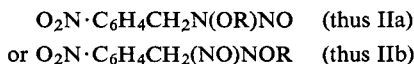

However, on investigating the ultra-violet absorption spectra of methylenedi-isonitramine, R. N. Jones and Thorn [67] failed to detect a band characteristic of

the nitroso group. This was accepted as evidence against the nitrosohydroxylamine structure of these compounds. On the other hand, the methyl ester of methylenedi-isonitramine has a spectrum typical of a nitro compound. Carmack and Leavitt [68] confirmed the absence of the NO group band in the ultra-violet spectrum of nitrosohydroxylamine derivative prepared by Cason and Prout [69] and ascribed this to the existence of a hydrogen bond:

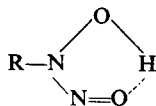

III

This bond cannot, of course, exist in an ester, in which a band characteristic of the nitroso group does occur.

Urbański and Piskorz [60] found that the properties of methylenedi-isonitramine salt differ markedly from those of methylenedinitramine salt. They also established that methylenedi-isonitramine is not a tautomeric modification of methylenedinitramine. In their most recent work [70] they have confirmed the nitrosohydroxylamine structure of isonitramines by examining the infra-red absorption spectra.

Under the influence of aqueous solutions of the water soluble salts of heavy metals the sodium salt of methylenedi-isonitramine gives precipitates of the salts of these metals. T. Urbański, Zacharewicz and Pietrzyk [61] suggested the use of certain heavy metal salts as initiators. Particularly interesting properties were demonstrated by the thallos salt $\text{CH}_2(\text{N}_2\text{O}_2\text{Ti})_2$.

In another investigation, T. Urbański and Wesołowski [71] studied the salts of nitromethylisonitramine:

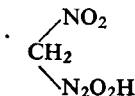

According to Traube [62] the sodium salt of the aci-modification of this compound is obtained by the action of nitric oxide on the sodium salt of nitromethane in the presence of sodium alcoholate:

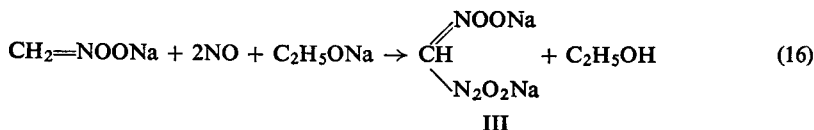

Some of the heavy metal salts of nitromethylisonitramine appear to have initiating properties, which are however considerably weakened by the presence of a nitro group. The salts of type III are therefore weaker initiators than the corresponding metal salts of methylenedi-isonitramine.

SALTS OF METAZONIC ACID

Metazonic acid is a nitroacetaldoxime:

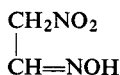

The aci-modification has the form

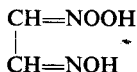

It is produced by the action of sodium hydroxide on nitromethane at an elevated temperature (Frieze [72]; Steinkopf and Kirchhoff [73]). Urbański and Kowalczyk [74] found that some heavy metal salts of this compound have weak initiating properties and that metazonic acid itself is a fairly weak explosive. Its expansion in the lead block is 240 cm³.

SALTS OF OXALIC ACID

As early as 1883 Berthelot [75] noticed that some salts of oxalic acid (e.g. mercuric or silver oxalates) have the properties of primary explosives.

This group of initiators has no practical application. Nevertheless it is interesting from the theoretical point of view, due chiefly to the fact that the general equation for the decomposition of oxalates is:

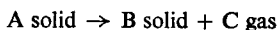

Thus it is similar to the decomposition of azides. There have been several papers on silver oxalate — Ag₂C₂O₄. Macdonald and Hinshelwood [76] confirmed the Berthelot equation, according to which the only products of decomposition of silver oxalate are metallic silver and CO₂.

Benton and Cunningham [77] found that the rate of thermal decomposition of silver oxalate may be increased by previously exposing it to ultra-violet radiation.

During the thermal decomposition of silver oxalate, fragments of metallic silver are formed. This has been confirmed by conductivity measurements (Macdonald and Sandison [78]) or by X-ray examination (Griffith [79]).

Tompkins [80] investigated the thermal decomposition of silver oxalate at 110–130°C. Its decomposition, in his opinion, is similar to that of barium azide.

Mercuric oxalate appears to undergo decomposition by a somewhat different mechanism with the formation of mercury and mercurous oxalate as intermediate products before full decomposition occurs (Prout and Tompkins [81]).

and common salt. 21 g of powdered citric acid is then poured into the solution while maintaining the temperature below 0°C. When all the citric acid has been added, the whole is agitated for 3 hr at 0°C and allowed to stand for 2 hr at room temperature. The white, crystalline product is filtered off and washed with water and alcohol to aid drying at room temperature.

The same compound was prepared by Leulier [89] by the action of hydrogen peroxide on hexamethylenetetramine in the presence of nitric acid, but in a lower yield than that in the Girsewald method. Leulier ascribed an incorrect formula to the substance as pointed out by Girsewald and Siegens [85].

Hexamethylenediamine peroxide is practically insoluble in water and in the majority of organic solvents. According to Taylor and Rinkenbach [90] it is volatile at a temperature higher than room temperature and at 75°C it decomposes markedly losing methylamine. At 100°C it is totally decomposed after 24 hr. When boiled in water it decomposes, and passes into solution with evolution of oxygen, the aqueous solution contains ammonia, formaldehyde, ethylene glycol, formic acid and hexamethylenetetramine.

When thrown onto a metallic surface heated to 200°C it explodes instantly, or on a surface at 149°C after 3 sec. It is a very powerful explosive. Its rate of detonation at a density of 0.88 in a pipe 5.5 mm in diameter is 4510 m/sec.

It is less sensitive to impact than mercury fulminate (a 3 cm drop is necessary to cause explosion, with a 2 kg weight, whereas for mercury fulminate a 2.5 cm drop is sufficient), but as an explosive it is much powerful than the latter.

As an initiator it is also much more powerful than mercury fulminate. Thus, trinitrotoluene is detonated by as little as 0.08 g of hexamethylenediamine peroxide compressed under a pressure of 67 kg/cm², whereas with mercury fulminate 0.26 g is required. For picric acid and tetryl 0.05 g of peroxide is sufficient to produce detonation as compared with 0.21–0.24 g of fulminate.

Its specific gravity is 1.57, but its apparent density only 0.66. A density of 0.91 can be obtained under a pressure of 170 kg/cm². It is not liable to become dead pressed even under a pressure of 730 kg/cm².

In spite of its initiating qualities, hexamethylenediamine peroxide is of no practical use due to its doubtful stability.

Recently Lefevre and Baranger [91] recommended it as a chemotherapeutic agent against cancer. They obtained positive results from oral treatment of cancer of the prostate gland.

Another peroxide, i.e. tetramethylenediperoxidodicarbamide has similar properties. It probably has the following structure:

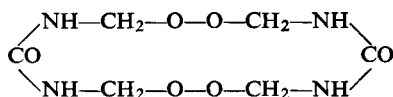

This compound was obtained by Girsewald and Siegens [92] by the action of hydrogen peroxide and nitric acid on an aqueous solution of urea and formaldehyde.

Spaeth [93] suggested its application as an initiator, but without practical success for the same reasons as with other peroxides, i.e. insufficient stability and a very high sensitiveness to mechanical stimulus.

Peroxides and ozonides are a wide group of compounds which are receiving a growing amount of attention for both theoretical and practical reasons. Particularly in the polymer industry peroxides have found wide application as catalysts and intermediates.

This subject is outside the scope of this book. Those interested should consult monographs and review articles and books by Rieche [94], Davies [95] and others [96-98].

ACETYLENE AND ITS SALTS (ACETYLIDES)

It has long been known that acetylene explodes under the influence of compression. Experiments by Rimarski and Metz [99] showed that at a temperature below 500°C acetylene does not explode if the pressure is lower than 3 kg/cm². An explosion may occur at 510°C under a pressure of 2.05 kg/cm². At room temperature acetylene may explode provided it is compressed adiabatically with a pressure of 170 kg/cm².

Acetylene is an endothermic compound, its heat of formation ($-\Delta H_f$) being -54.9 kcal/mole. Its heat of explosion is therefore very great, viz. 1870 kcal/kg, although the explosion is not connected with an oxidation reaction:

volume of gases (V_0) is 60 l./kg

temperature of explosion approximately 2700°C

Solid acetylene (m.p. about -83°C) is insensitive to impact, but at a density of 0.64 it can be detonated by a number 8 detonator, showing a rate of detonation of 2500 m/sec and a lead block expansion of 300 cm³.

Gaseous, compressed acetylene also detonates. According to Penny [100] when compressed to 8 atm in a pipe $\frac{1}{2}$ in. in diameter, it detonates with a rate of 1817 ± 7 m/sec and in a pipe 1 in. dia. with a rate of 1870 ± 22 m/sec. According to Mayes [101] when compressed to 3-6 atm in a pipe $1\frac{1}{2}$ in. dia., it detonates with a rate of 1848 m/sec.

The heavy metal salts of acetylene have the properties of primary explosives, but only cuprous acetylide was found to be satisfactory for practical use.

CUPROUS ACETYLIDE

Cuprous acetylide was prepared by Berthelot [102] as early as 1866 by the action of acetylene on an ammonia solution of cuprous chloride. Cuprous acetylide takes the form of a russet or reddish-brown powder, insoluble in water and in the majority of organic solvents.

Much research was necessary in order to establish the chemical composition of cuprous acetylide. Blochmann [103] and Scheiber and Reckleben [104] showed that the freshly precipitated and dried product has the approximate composition $\text{Cu}_2\text{C}_2 \cdot \text{H}_2\text{O}$. According to Keiser [105] drying this salt over sulphuric acid or calcium chloride (Scheiber and Reckleben [104]) gives an anhydrous product.

Küspert [106] drew attention to the fact that cuprous acetylide may form a colloidal solution. The colloidal state is favoured by the use of diluted ammonia solutions of cuprous salts.

The substance is stable at ordinary temperatures and up to 100°C . Like cupric acetylide it decomposes on being heated in hydrochloric acid (Berthelot [102], Sabaneyev [107]). A solution of potassium cyanide also causes decomposition with the loss of acetylene. Makówka [108] showed that aldehyde-like compounds are formed from cuprous acetylide on reaction with a 30% solution of hydrogen peroxide.

Cuprous acetylide explodes in air at $120\text{--}123^\circ\text{C}$, but in an acetylene atmosphere, under a pressure of 5 atm it decomposes without explosion at 250°C . According to Morgan [109] it is very easily exploded by an electric spark.

Apart from cuprous acetylide, with the formula Cu_2C_2 , there are complex cuprous salts prepared by the action of acetylene on certain cuprous salts in a neutral or slightly acidic medium; e.g. Bhaduri [110] obtained a cuprous acetylide containing a thiosulphate group by the action of acetylene on cuprous thiosulphate, and in the presence of potassium iodide Scheiber and Reckleben [104] precipitated an acetylide containing iodine.

Care should be taken that cuprous acetylide is not contaminated with cupric acetylide which may occur if the cuprous chloride used for the reaction contains cupric salt. This is of importance since cupric acetylide is unstable and explodes on heating even between 50 and 70°C . It is also more sensitive to impact and friction than cuprous acetylide. The pure cupric acetylide is black or brown.

Many authors recommend the precipitation of cuprous acetylide in the presence of reducing substances such as hydroxylamine (Ilosvay [111]), SO_2 (Rupe [112]), hydrazine sulphate (Cattelain [113]), so as to avoid contamination with cupric acetylide.

The precipitation of cuprous acetylide was introduced into analytical chemistry for the quantitative determination of copper. Since cupric acetylide was dangerous to handle, Makówka [108] worked out a method in which cupric salts are previously reduced, e.g. with hydroxylamine, to cuprous salts, when the acetylide is precipitated. Cuprous salts in a solution of hydroxylamine are employed as reagents for acetylene (e. g. Pietsch and Kotowski [114]).

Cuprous acetylide is used as the chief component of match heads in electric fuses, being particularly susceptible to ignition by sparks or a glowing wire to give a sharp, hot flame.

SILVER ACETYLIDE

Silver acetylide, Ag_2C_2 , is a white powder formed when acetylene is passed through an ammoniacal solution of silver chloride. It has even stronger explosive properties than cuprous acetylide due to its exceptionally large negative heat of formation ($-\Delta H_f = -87.15$ kcal/mole). Its ignition temperature is 200°C . It is of no practical value.

VARIOUS INITIATORS

NITROGEN SULPHIDE

Nitrogen sulphide, N_4S_4 , m.p. 178°C , was prepared by Soubeiran [115] by the action of ammonia on sulphur chloride dissolved in benzene

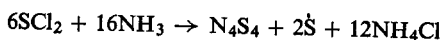

It is prepared by dissolving 1 volume of sulphur chloride in 8–10 volumes of carbon disulphide, cooling and passing in dry ammonia until the dark brown precipitate, first formed, has redissolved, producing an orange-yellow solution containing, flocks of ammonium chloride. The latter is filtered off and the filtrate is evaporated to dryness. The dry residue is extracted with boiling carbon disulphide to remove the sulphur. The undissolved material is crude nitrogen sulphide. On cooling the hot extract deposits a further quantity of the substance. The combined crude product is recrystallized from carbon disulphide.

Nitrogen sulphide is insoluble in water, slightly soluble in alcohol and ether, somewhat soluble in carbon disulphide and benzene. At room temperature it is hydrolysed to some extent by water to form free sulphur, sulphur dioxide and ammonia. Its specific gravity is 2.22.

Nitrogen sulphide is less sensitive to friction and impact than mercury fulminate. It is a weaker initiator than mercury fulminate, its rate of acceleration being considerably less than that of the latter. Its ignition temperature is 207°C . It is exceptionally strongly endothermic, its heat of formation ($-\Delta H_f$) being -138.8 kcal/mole (Berthelot and Vieille [116]).

In many patents nitrogen sulphide is recommended as a filling for fuses, primers etc. but in spite of this it has not been used in practice.

NITROGEN SELENIDE

Nitrogen selenide, N_4Se_4 , was prepared by Espenschied [117] by the action of ammonia on selenium chloride. It is an orange-red, amorphous, explosive powder.

The explosive properties of this substance were studied by Verneuil [118], and Berthelot and Vieille [116]. Its ignition temperature is 230°C . It is very sensitive to friction and impact. Its heat of formation ($-\Delta H_f$) is strongly endothermic: -169.2 kcal/mole.

SALTS OF THIOCYANIC ACID

At the beginning of the twentieth century the thiocyanates (rhodanates) of certain metals (e.g. mercury, copper) were recommended as components of cap compositions with potassium chlorate. The rhodanates were intended as a substitute for mercury fulminate, but only lead rhodanate acquired any practical significance.

Lead rhodanate, $\text{Pb}(\text{CNS})_2$ is formed, when a solution of lead nitrate, slightly acidified with nitric acid, is treated with a moderately concentrated solution of the rhodanate of an alkali metal.

When exposed to long day-light or ultraviolet irradiation lead rhodanate becomes yellow. When boiled in water it is converted into a basic salt $\text{Pb}(\text{CNS})_2 \cdot \text{Pb}(\text{OH})_2$ which behaves as a weak initiator. It is used as a constituent in some cap compositions.

COMPLEX SALTS

The complex salts of precious metals, formed by the action of ammonia either on aqueous solutions of silver, gold and platinum salts or on silver oxide were the first substances to reveal the ability to explode violently on heating, on direct contact with flame or by friction or impact ("fulminating" silver and gold).

Later it was found that a number of other metals which can give typical complex salts (Cd, Co, Cr, Cu, Fe, Hg, Mn, Ni and Zn) can form explosive co-ordination compounds.

These substances have a variable composition depending upon the reaction conditions, chiefly the concentration of the reagents used. Salvadori [119] called attention to the interesting explosive properties of the chlorates and perchlorates of complex "ammines" of the type:

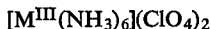
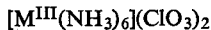
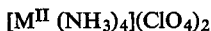
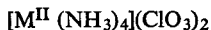

The explosive properties of these salts were partially studied by Ephraim and Jahnsen [120] and were later investigated in detail by Friedrich and Vervoort [121]. The latter also investigated the analogous combinations described by Franzen and Mayer [122], in which ammonia was replaced by hydrazine.

Friedrich and Vervoort found that the substance $[\text{Cu}(\text{NH}_3)_4](\text{ClO}_3)_2$ has initiating properties. It is however of no practical use, losing ammonia fairly rapidly in air. In damp air it is easily hydrolysed. Nickel ammino perchlorate $[\text{Ni}(\text{NH}_3)_6](\text{ClO}_4)_2$ is a fairly strong explosive with the rate of detonation 5300 m/sec at the density 1.39.

Friedrich and Vervoorst also prepared chlorates of hydrazinometals:

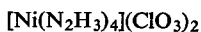
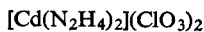

and similar perchlorates, which proved to be basic salts.

The chlorates are strong initiators with an initiating power exceeding that of mercury fulminate and even that of lead azide. The ignition temperature of the cadmium salt is 125°C, and that of the nickel salt 170°C. Basic perchlorates of cadmium and nickel are also initiators, weaker than the chlorates, but somewhat stronger than mercury fulminate.

The sensitiveness of all these salts to impact is very high, in many cases higher than that of mercury fulminate.

The corresponding nitrates (NO_3 instead of ClO_3 or ClO_4) do not possess initiating properties.

Another interesting group of explosive co-ordination compounds is formed by the azides of "ammines" of general formulae

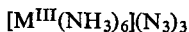
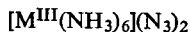
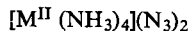
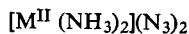

The salts of Cd, Cr, Cu^{II} , Ni were first prepared by Strecker and Schwinn [123]. They do not seem to possess sufficient stability to be of practical use.

Another type of complex cobalt ammine including azide groups in the co-ordination were obtained by Linhard and Flygare [124]:

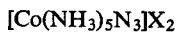

where X = Cl, Br, I, NO_3 , N_3



where Y = CrO_4 , S_2O_3 , S_2O_6

Only the perchlorate (X = ClO_4) shows marked sensitiveness and possibly initiating properties. The other compounds do not seem to possess properties interesting from the practical point of view.

Another kind of complex salts was obtained by Hodgkinson and Hoare [125] by the action of an ammoniacal solution of cupric, nickelous-nickelic or silver oxide on an alcoholic solution of tetranitromethane. Precipitates are then formed which are insoluble in water, explosive, but unstable, decomposing on boiling in water.

There are many other explosive complex salts but at present they are of no practical use.

An extensive review of various explosive complex compounds has been published by Fedoroff *et al.* [126].

SILVER PERCHLORATE

There are some indications that silver perchlorate has initiating properties since in some unexplained cases, the large crystals detonate on slight friction in a way similar to the detonation of crystals of lead azide or silver azide (Hein [127]).

These properties have not been examined in detail.

INITIATING COMPOSITIONS

Initiators are usually compositions from which the desired results are obtained by the interrelation of the components. This is of particular importance in the manufacture of percussion caps which are fired by striker pins to give a hot flame capable of igniting propellants and should therefore have ability to detonate.

Blasting caps, i.e. detonators, (Fig. 56, p. 218) were originally filled with mercury fulminate alone or with a 80:20 mixture of mercury fulminate and potassium chlorate. The chlorate is added to facilitate pressing since mercury fulminate alone cannot be pressed conveniently. In addition, potassium chlorate increases the ignitability of mercury fulminate, thus permitting a greater pressing pressure to be used which in turn improves coherence.

Mercury fulminate, or its mixture with potassium chlorate, is usually pressed under a pressure of 250–300 kg/cm². Pressed at pressures of 600 kg/cm² it ignites with difficulty and misfires may occur.

Detonators for mining explosives are manufactured in various sizes and numbered according to the amount of fulminate which they contain. The charges of fulminate for each size are shown in the following table:

TABLE 40

No. of detonator	1	2	3	4	5	6	7	8	9	10
Charge of mercury fulminate, g	0.3	0.4	0.54	0.65	0.8	1.0	1.5	2.0	2.3	3.0

In mining, a No. 8 detonator is used for ammonium nitrate explosives, No. 6 and No. 3 for nitroglycerine explosives.

Modern detonators have a double filling, i.e. a charge of high explosive such as tetryl or penthrite at the bottom, initiated by a layer of mercury fulminate or fulminate-chlorate placed on top (Fig. 56b). In this way more powerful detonators have been produced for mining purposes, containing the following charges:

TABLE 41

No. of detonator	5	6	7	8
Tetryl, g	0.3	0.4	0.75	0.9
Mercury fulminate, g	0.3	0.4	0.5	0.5

Detonators containing lead azide are loaded into aluminium capsules. Lead azide may be used alone or in conjunction with lead styphnate or tetrazene, the use of which facilitates ignition of azide. The layer of azide may also be covered

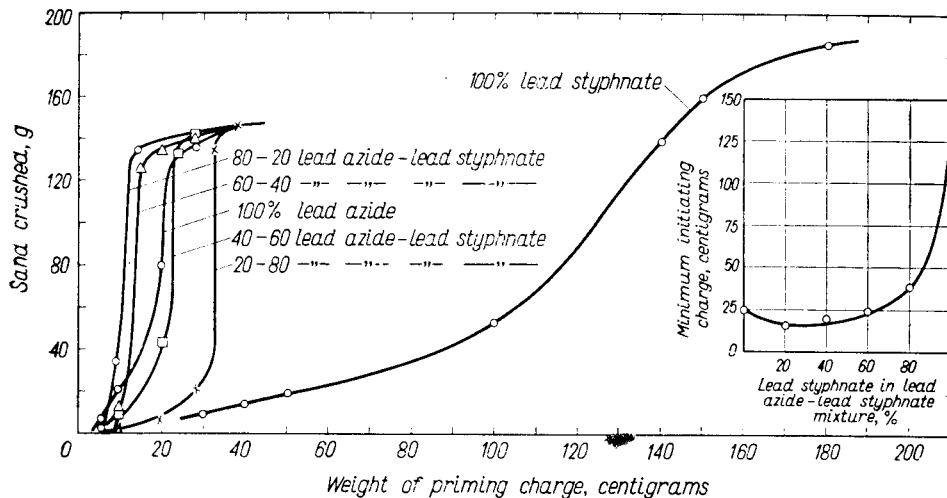

FIG. 58. Minimum initiating charge of lead azide, lead styphnate and their mixtures for 1.25 g of tetryl, according to Grant and Tiffany [40].

with a layer of lead styphnate. Lead azide or its mixtures may be pressed at a very high pressure (e.g. 1000 kg/cm²).

A general idea of the change in the minimum initiating charge of lead azide-lead styphnate mixtures with their composition is given in Fig. 58 by Grant and Tiffany [40]. The low priming ability of lead styphnate alone is also indicated.

The minimum charge required to detonate the base explosive in the detonator was determined by the sand test of Saelling [127a].

Aluminium detonators with lead azide and other explosives were used in the mining industry for some time, e.g. a No. 8 detonator, contained 1 g of tetryl and 0.3 g of a mixture of lead azide and lead styphnate. These were more powerful than those with a fulminate-tetryl charge, but the use of detonators with aluminium sheathing was soon forbidden in coal-mines due to the danger created by the burning of the aluminium.

The modern detonator TAT-1, used in U.S.S.R. is filled in three layers (Fig. 56c) as follows:

bottom—tetryl	0.12 g
middle—lead azide	0.21 g
top—lead styphnate	0.06 g

Modern artillery primers also include a charge of penthrite and lead azide sensitized to flame by the addition of lead styphnate or tetrazene.

(1) The bottom layer is loaded with 0.35 g of penthrite (pressed at 1800 kg/cm²), the middle with 0.35 g of penthrite (not pressed) and the top with 0.30 g of a mixture of 92.5% of lead azide and 7.5% of tetrazene (pressed at 1100–1800 kg/cm²).

Thus a layer of bursting charge adjacent to the initiator is compressed more weakly and in consequence complete explosion occurs with greater ease.

(2) The bottom layer is loaded with 0.2 g of penthrite (pressed under a pressure of 500 kg/cm²), the middle with 0.2 g of penthrite (not pressed) and the top with 0.4 g of a mixture of 80% of lead azide and 20% of lead styphnate (pressed under a pressure of 500 kg/cm²).

Mixtures of mercury fulminate, potassium chlorate (as an oxidizing agent), antimony sulphide and ground glass were widely utilized for many years in percussion caps. The content of mercury fulminate was small so that the mixture had no explosive properties. For the same reasons significant amounts of potassium chlorate were used as an oxidizing agent, thus diluting the fulminate to some extent. Antimony sulphide is a combustible component which gives a hot flame. Ground glass was added in order to increase the internal friction and make it more sensitive to percussion.

Some compositions also contained an adhesive, e.g. shellac, gum etc.

A German composition of 1883 contained, for example:

Mercury fulminate	27%
Potassium chlorate	37%
Antimony sulphide	29%
Ground glass	7%

To 100 parts of this mixture 0.6 part of shellac were added.

The composition of other caps according to Gorst [128] is given in Table 42.

TABLE 42

Cap	Mercury fulminate	Potassium chlorate	Antimony sulphide
Rifle and pistol	16.5	55.5	28.0
Fuse	25	37.5	37.5
Fuse	50	25	25

The English caps contained a little blackpowder which elongates the flame produced by the explosion of

Mercury fulminate	by	15%
Potassium chlorate	by	35%
Antimony sulphide	by	45%
Sulphur	by	2.5%
Blackpowder	by	2.5%

Mixtures containing mercury fulminate, potassium chlorate, and antimony sulphide tend to destroy the inside of firearm barrels, since on decomposition the mercury fulminate evolves free mercury which causes erosion of the barrel at the

high temperatures created inside the bore. Decomposition of the potassium chlorate gives potassium chloride which remains in the bore and strongly corrodes the steel. Sulphur dioxide formed by the combustion of antimony sulphide also helps to destroy the barrel. For a long time therefore, the use of compositions not containing mercury fulminate and potassium chlorate were advocated, but a satisfactory formulation for non corrosive mixtures was found ("Sinoxyd") only when lead styphnate was introduced as their chief component. Since styphnate is hard to ignite by impact it was sensitized by an admixture of tetrazene. At the same time potassium chlorate was replaced by barium nitrate.

German compositions for rifle and pistol caps are tabulated below [31, 32].

TABLE 43

Components	Composition No. 30/40 for rifle and pistol caps	Composition for rifle caps manufactured at Stadeln
Lead styphnate	40	30-35
Tetrazene	3	2-3
Barium nitrate	42	40-45
Lead dioxide	5	5-8
Calcium silicide	10	6-12
Antimony sulphide	—	6-9

The Czechoslovak mixture, Oxyd, for pistol cartridges has a similar composition, viz.:

Lead styphnate	45%
Tetrazene	5%
Barium nitrate	33%
Antimony sulphide	20%
Aluminium-magnesium alloy	5%

The German mixture No. 30 for the friction fuses of hand grenades has the following composition:

Lead styphnate	25%
Barium nitrate	25%
Lead dioxide	24%
Silicon	15%
Ground glass	3%

THE PREPARATION OF PRIMER COMPOSITIONS

Formerly cap compositions were prepared by mixing the well-damped components on a glass-topped table, while adding water continuously to the mixture (especially at the edges which are liable to more rapid drying). A wooden spade was used for mixing. The mixture in the form of a paste, was made into pellets which were then dried and pressed either into the sheaths of blasting caps or into the capsules of percussion caps.

This method was widely employed before World War I and for some time afterwards, but it is now discontinued due to the changes which occur during storage to caps so manufactured. These changes reduced the caps efficiency possibly due

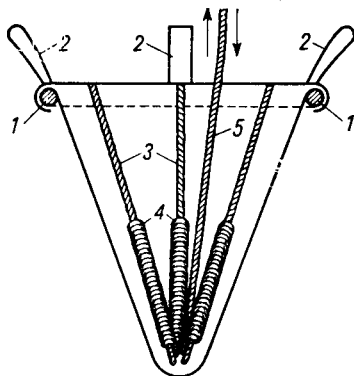

FIG. 59. Silk bag for mixing an initiating composition: 1—rubber frame, 2—leather lug for suspending the bag, 3—strings, 4—rubber rings, 5—mixing string, according to Vennin, Burlot and Lécorché [132].

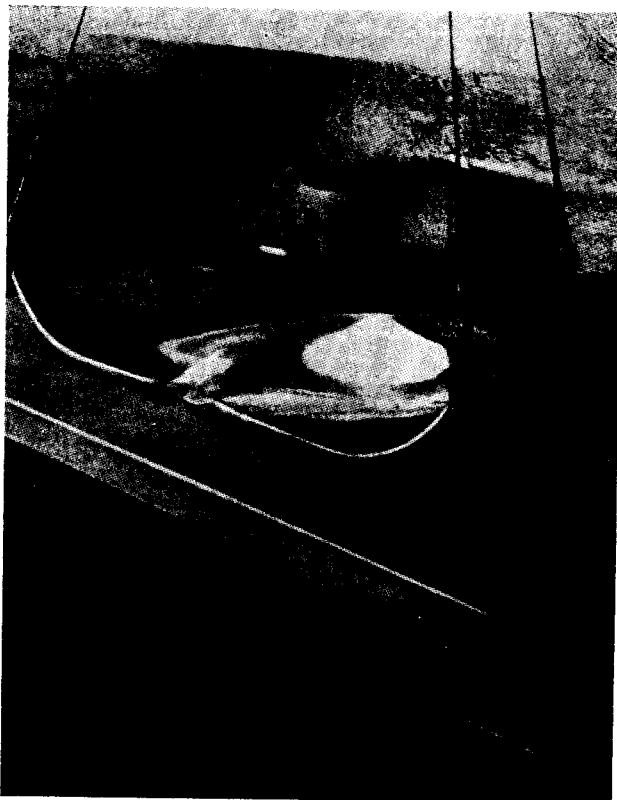

FIG. 60. Mixing of primary explosive charge on a rubber tray at Hercules Powder Company, according to Davis [133].

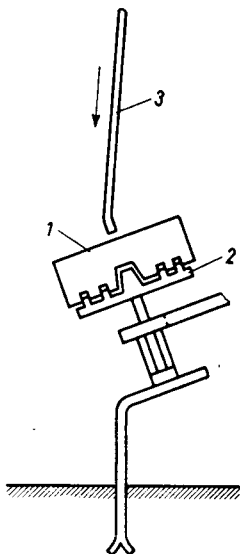

FIG. 61. A device for mixing and simultaneously drying an initiating composition: 1—ebonite drum, 2—tilted revolving drum plate, 3—warm air conduit, according to Vennin, Burlot and Lécorché [132].

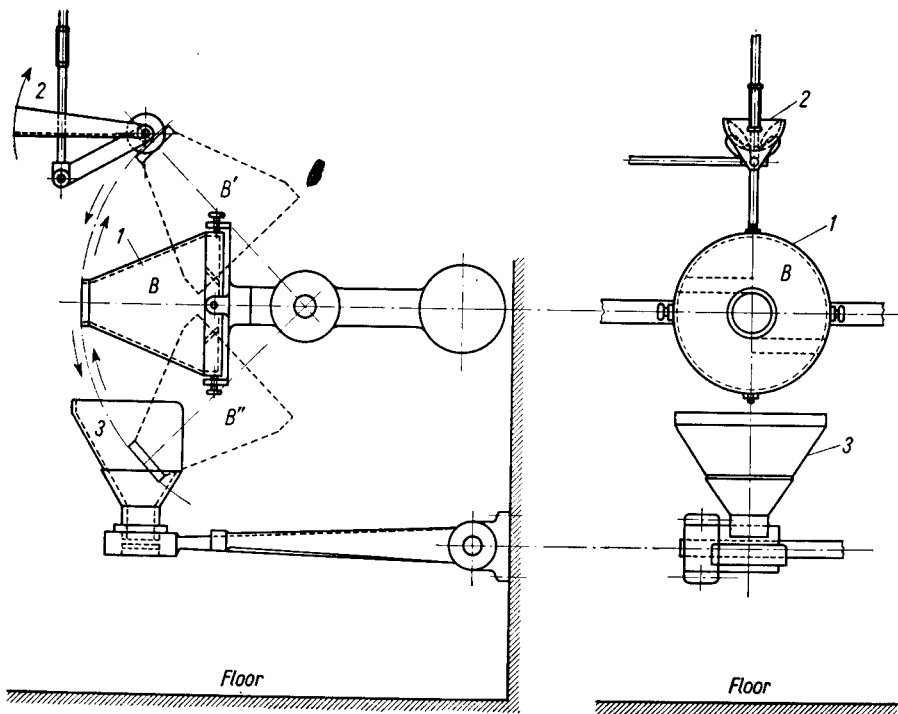

FIG. 62. Automated arrangement for mixing initiating compositions at Stadeln [130]: 1—papier mâché drum (*B*—in a horizontal position when mixed, *B'*—when loaded, *B''*—when unloaded), 2—papier mâché spoon, 3—paper funnel.

to traces of moisture in the cap composition which are particularly persistent if binders such as gum arabic etc. have been incorporated. The presence of moisture also enhances the reaction of mercury fulminate with the metal into which the composition is pressed.

For this reason the components are now not mixed wet. There are several methods of dry mixing. One of them (the earlier "jelly-bag" method) is to place the

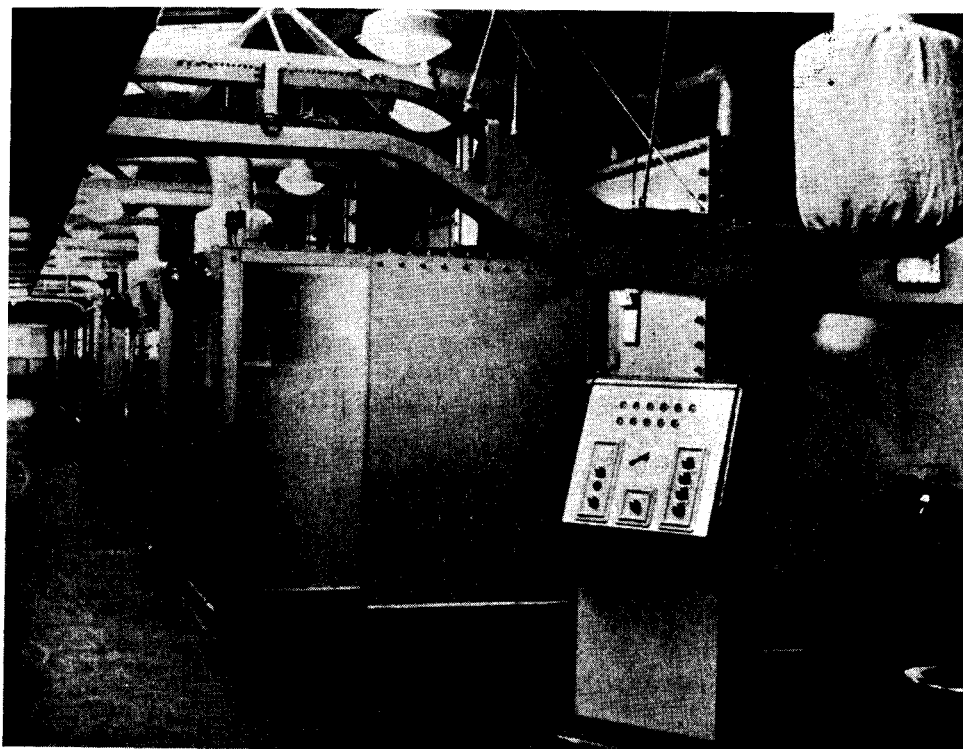

FIG. 63. Detonator manufacture—a line of compartments in which the filling and pressing of detonators is carried out automatically. Courtesy Imperial Chemical Industries Ltd., Nobel Division.

dried and sieved components of the composition into a conical silk bag (Fig. 59) which is fastened at its base to a rubber frame. There are strings within the bag fitted with rubber rings. Another string fastened to the top of the cone passes over a pulley fixed to the ceiling. This string leads outside the building or protective wall. By manipulating the strings the bag is put into motion and its contents are stirred. The bag is emptied by turning it upside down by a pull on the string.

The same type of arrangement for mixing primary explosive charge used by the Hercules Powder Company, according to Davis [129], is shown in Fig. 60. It consists of a triangular rubber tray. The composition is mixed by lifting and lowering the corners of the tray in turn. The lifting and lowering is accomplished behind a concrete safety barriers.

In a more modern method, the mixing may be combined with drying. A diagram illustrating such a device is presented in Fig. 61. Here the composition is placed in an open ebonite drum which is laid on a tilted, revolving plate. The moist components are placed in the drum (weighed and containing a known amount of moisture),

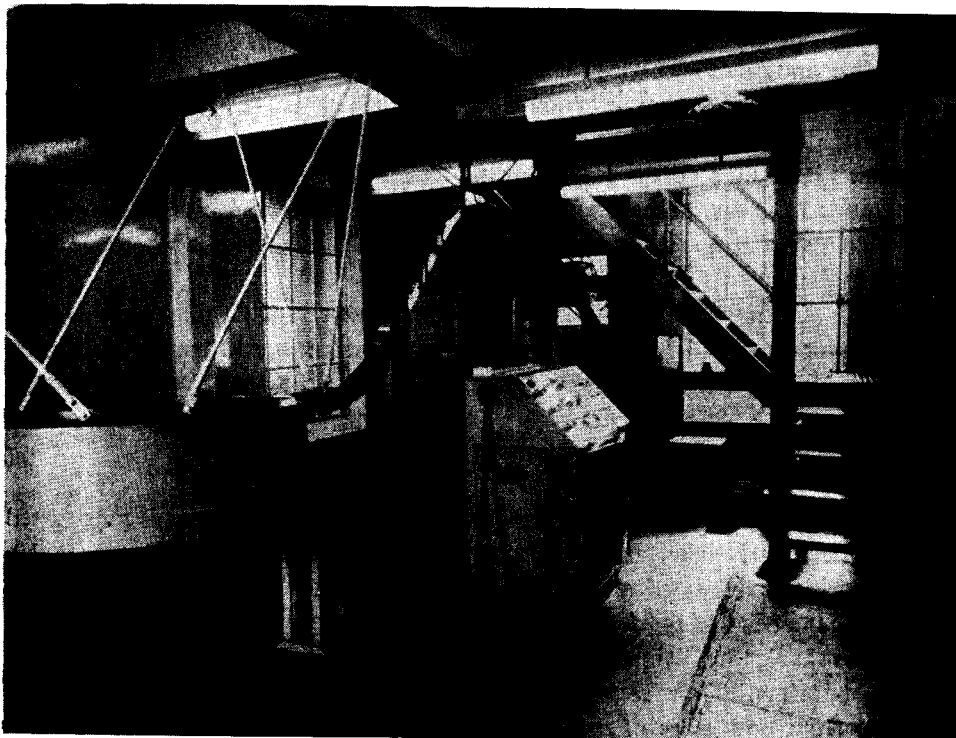

FIG. 64. Detonator manufacture—the plating section of the automatic plain detonator unit. Courtesy Imperial Chemical Industries Ltd., Nobel Division.

and the latter is then aerated with a warm air stream which dries the contents when stirred. This system can also be used for drying initiators, e.g. mercury fulminate, lead azide etc.

In the German plant at Stadeln [130] drums of papier mâché about 20 cm in diameter and 45 cm long are used, mounted on a horizontal, revolving axis, and provided with an aperture on the drums' cylindrical surface. Before being set in motion this opening is closed with a rubber cork. Subsequently it is opened by remote control by means of hooks and strings. After being stirred, the contents of the drum are poured into boxes previously ranged in readiness. Each drum is sited in a chamber, protected by a concrete partition wall. It is desirable to cover the floor with a soft material that conducts electricity. With compositions which are very dangerous to handle, containing lead styphnate, stirring proceeds stepwise so that the preparation of the final, dangerous composition lasts for as short a time as possible. Thus a composition consisting of barium nitrate, calcium silicide, antimony sulphide and lead

dioxide is first prepared. This composition is manufactured in large amounts in ordinary, wooden drums. A weighed amount of the composition is then mixed automatically with tetrazene and lead styphnate (Fig. 62). The papier mâché drums are in the shape of a truncated cone with bases of about 8–30 cm in diameter. Such a drum will hold about 400 g of material. Above the drum there is a papier mâché spoon into which a worker pours a batch of the mixture. The worker then leaves the building and sets the driving mechanism in motion from a distance. This engine first rotates the spoon so that its contents run into the drum. Then the drum is moved into a horizontal position, in which it revolves for 7 min with a velocity of 60 r.p.m., from which it is tilted downwards, pouring its contents into a paper funnel. After being emptied the drum is returned to the initial position and the drive is stopped. The whole mechanism is so arranged that all these movements are carried out automatically.

An idea of a modern plant lay-out for the manufacture of priming compositions and detonators is given by Figs. 63 and 64 showing installations at Imperial Chemical Industries, Nobel Division, in Great Britain.

COMPOSITIONS FOR EXPLOSIVE RIVETS

In 1937 rivets containing a small explosive charge in their shanks were constructed (Aircraft Factory Heinkel and Rheinisch-Westphälische Sprengstoff A. G. [131]). The composition of the explosive mixture is so selected that a slight explosion occurs on heating the head of the rivet with a hot iron. The explosion causes an expansion of the shank thus fixing the rivet in place. Explosive rivets have found wide application primarily for riveting aircraft components in which rivets are not accessible from both sides of the riveted surface.

Initially only aluminium alloy rivets (duralumin) were employed. Later, during World War II, steel explosive rivets were also used. The principle is limited to rivets of small size. For filling these rivets, charges of chlorate explosive mixtures with fairly low ignition temperatures (e.g. 180°C) were originally used. Their composition was similar to that of priming caps. During World War II the following mixture was used for aluminium rivets:

Nitromannite	15%
Tetrazene	10%
Aluminium	70%
Adhesive	5%

LITERATURE

1. M. BERTHELOT and P. VIEILLE, *Mém. poudres* 1, 99 (1882–83).
2. L. WÖHLER and O. MATTER, *Z. ges. Schiess- u. Sprengstoffw.* 2, 181 (1907).
3. E. HERZ, Ger. Pat. 258679 (1911).
4. E. BAMBERGER, *Ber.* 28, 444 (1895).
5. A. HANTZSCH and W. B. DAVIDSON, *Ber.* 27, 1522 (1896).

6. A. KLEMENC, *Ber.* **47**, 1407 (1914).
7. L. WOLFF, *Ann.* **312**, 119 (1900).
8. H. H. HODGSON and E. MARSDEN, *J. Soc. Dyers Colourists* **59**, 271 (1943).
9. J. D. C. ANDERSON and R. J. W. LE FÈVRE, *Nature* **162**, 449 (1948).
10. B. GŁOWIAK, *Bull. Acad. Polon. Sci., sér. chim.* **8**, 1 (1960).
11. P. GRIESS, *Ann.* **106**, 123 (1858).
12. W. LENZE (1892), according to H. KAST, *Spreng- u. Zündstoffe*, p. 433, Vieweg & Sohn, Braunschweig, 1921.
13. D. SMOLEŃSKI and J. PLUCIŃSKI, *Biul. WAT*, 4-5, 22 (1953).
14. F. M. GARFIELD, U.S. Pat. 24080059 (1946).
15. L. V. CLARK, *Ind. Eng. Chem.* **25**, 663, 1385 (1933).
16. J. VAUGHAN and L. PHILLIPS, *J. Chem. Soc.* **1947**, 1560.
17. J. V. R. KAUFMAN, Discussion Roy. Soc., Initiation and Growth of Explosion in Solids, *Proc. Roy. Soc. (London)* **A 246**, 219 (1958).
18. T. URBAŃSKI, K. SZYC-LEWAŃSKA, M. BEDNARCZYK and J. EJSMUND, *Bull. Acad. Polon. Sci., sér. chim.* **8**, 587 (1960).
19. A. F. BELAYEV and A. E. BELAYEVA, *Dokl. Acad. Nauk SSSR* **52**, 507 (1946); *Zh.fiz. khim.* **20**, 1381 (1946).
20. B. GŁOWIAK, *Bull. Acad. Polon. Sci., sér. chim.* **8**, 9 (1960).
21. G. PONZIO, *Gazz. chim. ital.* **45**, II, 12 (1915).
22. A. QUILICO, *Gazz. chim. ital.* **62**, 503, 912 (1932).
23. G. PONZIO, *Gazz. chim. ital.* **63**, 471 (1933).
24. J. F. KENNEY, (Remington Arms Co. Inc.) U.S. Pat. 2728760 (1955); *Chem. Abstr.* **50**, 7462 (1956); *Chem. Zentr.* **1957**, 1082.
25. K. A. HOFFMANN and R. ROTH, *Ber.* **43**, 682 (1910).
26. K. A. HOFFMANN, H. HOCK and R. ROTH, *Ber.* **43**, 1087 (1910); K. A. HOFFMANN and H. HOCK. *Ber.* **43**, 1866 (1910); **44**, 2946 (1911); K. A. HOFFMANN, H. HOCK and H. KIRMREUTHER, *Ann.* **380**, 131 (1911).
27. S. H. PATINKIN, J. P. HORWITZ and E. LIEBER, *J. Am. Chem. Soc.* **77**, 562 (1955).
28. H. RATHSBURG, Ger. Pat. 362433, 400814 (1921).
29. R. WALLBAUM, *Z. ges. Schiess- u. Sprengstoffw.* **34**, 126, 197 (1939).
30. W. H. RINKENBACH and O. E. BURTON, *Army Ordnance* **12**, 120 (1931).
31. CIOS Report XXVII-38, Manufacture of Initiating Explosives.
32. CIOS Report XXXIII-48, Report on the Visit to D.A.G. Small Arms Factory, Stadeln.
33. T. L. DAVIS and E. N. ROSENQUIST, *J. Am. Chem. Soc.* **59**, 2114 (1937).
34. A. CHRETIEN and B. WORINGER, *Compt. rend.* **232**, 1115 (1951).
35. H. M. MONTAGU-POLLOCK, *Proc. Roy. Soc. (London)* **A 269**, 219 (1962).
36. F. P. BOWDEN and H. M. MONTAGU-POLLOCK, *Nature* **191**, 556 (1961).
37. A. F. MCKAY, *Can. J. Research* **23 B**, 683 (1950).
38. A. F. MCKAY, W. G. HATTON and G. W. TAYLOR, unpublished work, according to S. R. HARRIS [39].
39. S. R. HARRIS, *J. Am. Chem. Soc.* **80**, 2302 (1958).
40. R. L. GRANT and J. E. TIFFANY, *Ind. Eng. Chem.* **37**, 661 (1945).
41. T. URBAŃSKI and K. KRUSZYŃSKA (SZYC-LEWAŃSKA), unpublished work (1937).
42. BIOS Final Report No. 833.
43. P. GRIESS, *Ber.* **7**, 1224 (1874).
44. R. A. ZINGARO, *J. Am. Chem. Soc.* **76**, 816 (1954).
45. E. HERZ, U.S. Pat. 1443328 (1919).
46. A. STETTbacher, *Nitrocellulose* **8**, 3 (1937).
47. W. H. RINKENBACH in R. E. KIRK and D. F. OTHMER (Eds.), *Encyclopedia of Chemical Technology*, Vol. 6, Interscience, New York, 1951.

48. H. R. HAILES, *Trans. Faraday Soc.* **29**, 544 (1933).
49. W. E. GARNER, A. S. GOMM and H. R. HAILES, *J. Chem. Soc.* **1933**, 1393.
50. F. C. TOMPKINS and D. A. YOUNG, *J. Chem. Soc.* **1956**, 3331.
51. J. I. EVANS and A. M. YUILL, Discussion Roy. Soc., Initiation and Growth of Explosion in Solids, *Proc. Roy. Soc. (London)* **A 246**, 176 (1958).
52. G. J. BRYAN and E. C. NOONAN, Discussion Roy. Soc., Initiation and Growth of Explosion in Solids, *Proc. Roy. Soc. (London)* **A 246**, 167 (1958).
53. J. H. MCAUSLAN, Ph.D. Thesis, Cambridge, 1957, according to F. P. BOWDEN and A. D. YOFFE, *Fast Reactions in Solids*, Butterworths, London, 1958.
54. J. BARCIKOWSKI, DOBRZYŃSKI and KIELCZEWSKI, unpublished work (1938).
55. I. HARTMANN, J. NAGY and H. R. BROWN, U.S. Bureau of Mines Techn. Paper 3722 (1943).
56. G. MORRIS, *Engineering* **164**, 49, 73 (1947).
57. J. TAYLOR and R. H. HALL, according to MORRIS [56].
58. J. MEISSNER, Brit. Pat. 500711 (1939).
59. J. MEISSNER, private information (1964).
60. T. URBAŃSKI, M. PISKORZ and J. MAZUR, *Biul. WAT* **8**, No. 84, 112 (1959).
61. T. URBAŃSKI and J. ZACHAREWICZ, *Wiad. Techn. Uzbr.* **18**, 16 (1932); T. URBAŃSKI and C. PIETRZYK, *Wiad. Techn. Uzbr.* **IV**, 10 (1935).
62. W. TRAUBE, *Ber.* **27**, 1507, 3291 (1854); *Ann.* **300**, 81 (1898).
63. M. GOMBERG, *Ann.* **300**, 59 (1898).
64. A. HANTZSCH, *Ber.* **31**, 177 (1898).
65. A. ANGELI, *Ber.* **29**, 1885 (1896); **59**, 1401 (1926); *Gazz. chim. ital.* **46**, II, 67 (1916).
66. A. HANTZSCH and E. STRASSER, *Ber.* **64**, 656 (1931).
67. R. N. JONES and G. D. THORN, *Can. J. Research* **27B**, 828 (1949).
68. M. CARMACK and J. J. LEAVITT, *J. Am. Chem. Soc.* **71**, 1221 (1949).
69. J. CASON and F. S. PROUT, *J. Am. Chem. Soc.* **71**, 1218 (1949).
70. M. PISKORZ and T. URBAŃSKI, *Bull. Acad. Polon. Sci., sér. chim.* **11**, 597 (1963).
71. T. URBAŃSKI and T. WESOŁOWSKI, *Wiad. Techn. Uzbr.* **18**, 28 (1932).
72. P. FRIESE, *Ber.* **9**, 394 (1876).
73. W. STEINKOPF and C. KIRCHHOFF, *Ber.* **42**, 2030 (1909).
74. T. URBAŃSKI and M. KOWALCZYK, *Wiad. Techn. Uzbr.* **IV**, 22 (1935).
75. M. BERTHELOT, *Sur la force des matières explosives*, Paris, 1883.
76. J. Y. MACDONALD and C. H. HINSHELWOOD, *J. Chem. Soc.* **127**, 2764 (1925).
77. A. F. BENTON and G. L. CUNNINGHAM, *J. Am. Chem. Soc.* **57**, 2227 (1935).
78. J. Y. MACDONALD and R. SANDISON, *Trans. Faraday Soc.* **34**, 589 (1938).
79. R. L. GRIFFITH, *J. Chem. Phys.* **11**, 499 (1943).
80. F. C. TOMPKINS, *Trans. Faraday Soc.* **44**, 206 (1948).
81. E. G. PROUT and F. C. TOMPKINS, *Trans. Faraday Soc.* **43**, 148 (1947).
82. A. BAEYER and V. VILLIGER, *Ber.* **33**, 2479 (1900).
83. T. URBAŃSKI, unpublished work (1930).
84. *Jahresber. Chem.-Techn. Reichsanstalt* **5**, 124 (1926).
85. C. GIRSEWALD and S. SIEGENS, *Ber.* **54**, 490 (1921).
86. L. LEGLER, *Ber.* **18**, 3343 (1885).
87. C. GIRSEWALD, *Ber.* **45**, 2571 (1912); **47**, 2464 (1914); Ger. Pat. 274522 (1912).
88. K. SZYC-LEWAŃSKA and T. URBAŃSKI, *Bull. Acad. Polon. Sci., sér. chim.* **6**, 165 (1958).
89. A. LEULIER, *J. pharm. chim.* [7], **15**, 222 (1917).
90. C. TAYLOR and W. H. RINKENBACH, *Army Ordnance* **5**, 463 (1924).
91. R. LEFEVRE and P. BARANGER, *Acta Union Intern. contre Cancer* **16**, 887 (1960).
92. C. GIRSEWALD and S. SIEGENS, *Ber.* **47**, 2464 (1911).
93. C. P. SPAETH, U.S. Pat. 1984846 (1935).
94. A. RIECHE, *Alkylperoxyde (und Ozonide)*, Steinkopff, Dresden-Leipzig, 1931.

95. A. G. DAVIES, *Organic Peroxides*, Butterworth, London, 1961.
96. A. V. TOBOLSKY and R. B. MESROBIAN, *Organic Peroxides*, Interscience, New York, 1954.
97. R. CRIGEE, *Methoden der Organischen Chemie*, HOUBEN-WEYL, E. MÜLLER (Ed.), Thieme, Stuttgart, 1957.
98. V. KARNOJITZKI, *Les Peroxydes Organiques*, Hermann, Paris, 1958.
99. W. RIMARSKI and L. METZ, *Autogene Metallbearbeitung* **26**, 341 (1933).
100. E. PENNY, *Disc. Faraday Soc.* **22**, 157 (1956).
101. H. A. MAYES, *Disc. Faraday Soc.* **22**, 213 (1956).
102. M. BERTHELOT, *Ann. chim.* [4], **9**, 393 (1866).
103. R. BLOCHMANN, *Ann.* **173**, 167 (1874).
104. I. SCHEIBER and H. RECKLEBEN, *Z. anal. Chem.* **48**, 529 (1909); *Ber.* **44**, 210 (1911).
105. E. H. KEISER, *Am. Chem. J.* **14**, 285 (1892).
106. F. KÜSPERT, *Z. anorg. Chem.* **34**, 453 (1903).
107. A. SABANEYEV, *Ann.* 109 (1875).
108. O. MAKÓWKA, *Ber.* **41**, 824 (1908).
109. J. D. MORGAN, *Phil. Mag.* **45**, 968 (1923).
110. K. BHADURI, *Z. anorg. Chem.* **76**, 419 (1912); **79**, 355 (1913).
111. L. ILOSVAY, *Ber.* **32**, 2697 (1899); *Z. anal. Chem.* **40**, 123 (1901).
112. H. RUPE, *J. prakt. Chem.* [2], **88**, 79 (1913).
113. E. CATTELAINE, *J. pharm. chim.* [8], **3**, 321 (1926).
114. E. PIETSCH and A. KOTOWSKI, *Z. angew. Chem.* **44**, 309 (1931).
115. SOUBEIRAN, *Ann. Chim.* [2], **67**, 71 (1838).
116. M. BERTHELOT and P. VIEILLE, *Mém. poudres* **2**, 3 (1884-89).
117. R. ESPENSCHIED, *Ann.* **113**, 101 (1860).
118. VERNEUIL, *Bull. soc. chim. France* [2], **338**, 548 (1882).
119. R. SALVADORI, *Gazz. chim. ital.* **40**, II, 9 (1910); **42**, I, 458 (1910).
120. F. EPHRAIM and A. JAHNSEN, *Ber.* **48**, 41 (1915).
121. W. FRIEDRICH and P. VERVOORST, *Z. ges. Schiess- u. Sprengstoffw.* **21**, 49 (1926).
122. H. FRANZEN and O. V. MAYER, *Z. anorg. Chem.* **60**, 247 (1908); **70**, 145 (1911).
123. W. STRECKER and E. SCHWINN, *J. prakt. Chem.* **152**, 205 (1939).
124. M. LINHARD and H. FLYGARE, *Z. anorg. Chem.* **262**, 233, 245, 338 (1950).
125. W. R. HODGKINSON and F. R. I. HOARE, according to *Chem. Zentr.* **1914** II, 435.
126. B. T. FEDOROFF, H. A. AARONSON, E. F. REESE, O. E. SHEFIELD, G. D. CLIFT *et al.*, *Encyclopedia of Explosives and Related Items*, Vol. I, Picatinny Arsenal, Dover, N. J., 1960.
127. F. HEIN, *Chem. Technik* **9**, 97 (1957); *Angew. Chem.* **69**, 274 (1957).
- 127a. According to C. E. MUNROE and J. E. TIFFANY, *Physical Testing of Explosives*, Bull. 346, U.S. Dept. of Commerce, Bureau of Mines, Washington, 1931.
128. A. G. GORST, *Porokha i vzrychatyye veshchestva*, Oborongiz, Moskva, 1957.
129. T. L. DAVIS, *The Chemistry of Powder and Explosives*, J. Wiley, New York, 1943.
130. BIOS Final Report No. 1074, The Manufacture of 22 Rimfire Ammunition Dynamit A.G. at Nürnberg and Stadeln.
131. E. Heinkel Flugzeugwerke, Rostock und Rheinisch-Westphälische Sprengstoff A.G., Nürnberg, Ger. Pat. 648842, 655669 (1937); W. TESKE, *Aluminium* **19**, 523 (1937); **21**, 655 (1939); *Der Aluminium Praktiker* **1939**, 655.
132. L. VENNIN, E. BURLLOT and H. LÉCORCHÉ, *Les poudres et explosifs*, Librairie Polytechnique Béranger, Paris-Liège, 1932.
133. T. L. DAVIS, *The Chemistry of Powder and Explosives*, J. Wiley, New York, 1943.

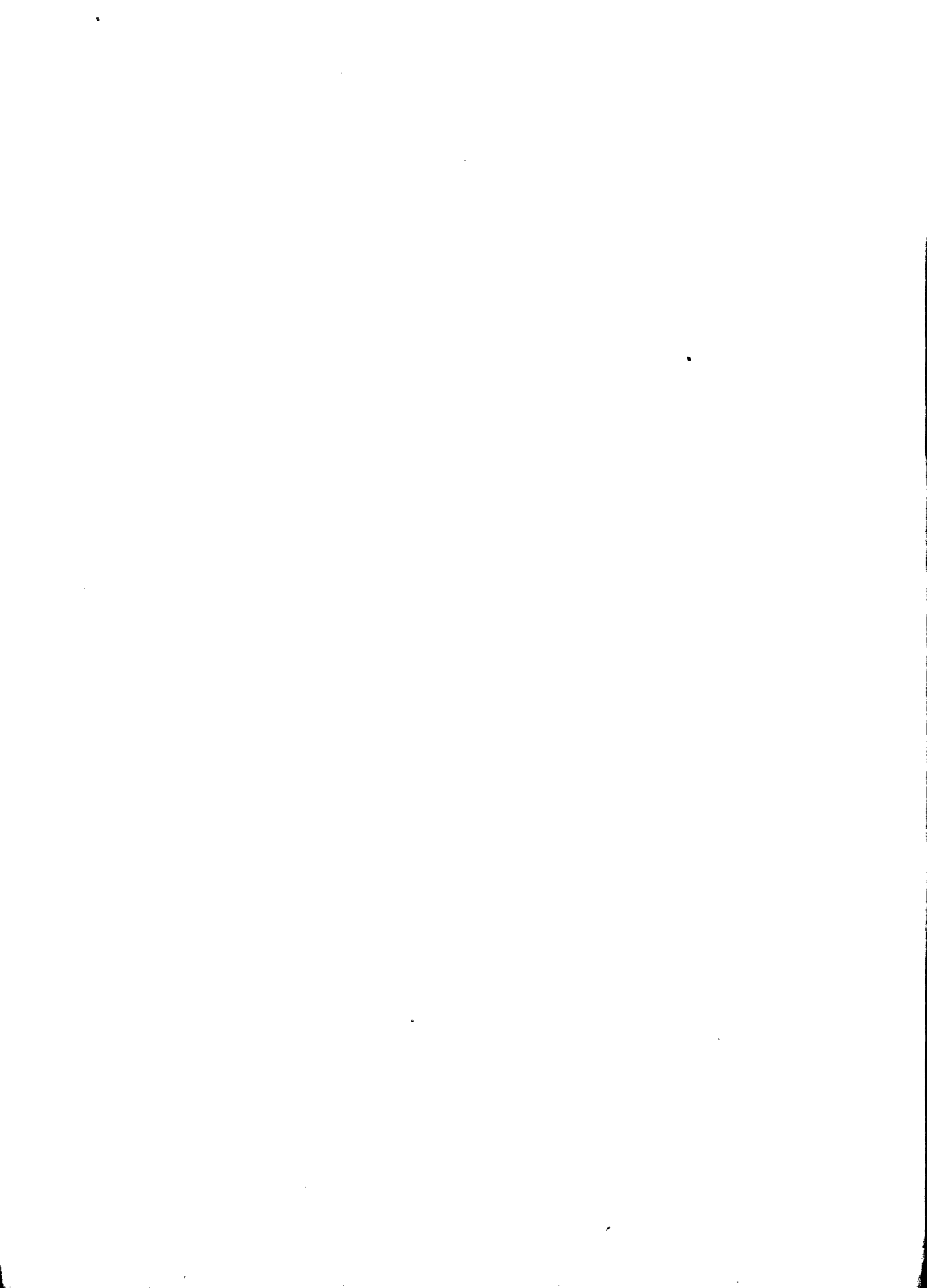

Part 3

COMPOSITE EXPLOSIVES

GENERAL INFORMATION

Most modern explosives used for practical purposes are not single chemical substances, but composite mixtures, their ingredients being selected to obtain the required properties.

Thus, if there is a need to reduce the melting point of a nitro compound, e.g. picric acid, other nitro compounds are added to form an eutectic mixture; to decrease the sensitiveness of picric acid to mechanical impact it is mixed with paraffin.

Smokeless propellants may be taken as another example of composite explosives. These may be either mixtures of nitrocellulose of differing degrees of nitration, partly in a colloidal and partly in a fibrous state with an admixture of the remaining solvent and a stabilizer or a solution of nitrocelluloses in carbamite (centralite) and nitroglycerine with an admixture of components such as aromatic nitro compounds, nitroguanidine, graphite etc.

Blackpowder is yet another type of composite explosive being an intimate mixture of potassium nitrate, charcoal and sulphur. A distinguishing feature of this composition is that none of its components is explosive. Blackpowder and similar compositions are examples of a large group of explosives which contain an oxidizing agent as a chief component. Salts of nitric acid, e.g. ammonium, sodium and potassium nitrates and oxy-salts of chlorine such as ammonium and potassium perchlorates or sodium and potassium chlorates are used as oxidizing agents. Other constituents of such mixtures are combustible substances. These are often explosive substances such as aromatic nitro compounds. Explosive mixtures are frequently formulated so as to fully utilize the oxygen present in the oxidizing agents.

The amount of high melting material present, e.g. ammonium nitrate, regulates the fusibility of these mixtures so that they may be fusible, semi-fusible or infusible, free-pouring. There are also explosives with a plastic consistency. Usually these consist of a plastic substratum containing a polymeric component. Again, there are liquid explosives, containing liquid oxygen or a liquid oxidizing agent, e.g. nitrogen dioxide.

Finally, mention should be made of a group of explosives in which the components are selected on another principle. These mixtures contain combustibles which

increase considerably the heat of explosion, for instance aluminium, ferrosilicon etc. They burn by utilizing the oxygen contained in the explosive.

Composite explosives will be considered, according to their uses, in three main categories: the high explosives, the low explosives or propellants and the primary explosives or initiators.

High explosives will be classified primarily according to their consistency, which may be fusible, semi-fusible or infusible, plastic or liquid. They will then be arranged according to their most characteristic component.

Propellants will be grouped on the basis of their composition, into blackpowder and similar mixtures, smokeless powders and rocket liquid propellants.

Because of the importance of rocket liquid propellants a separate chapter will be dedicated to these mixtures. It will also include liquid high explosives.

Initiating compositions were reviewed together with primary explosives.

CHAPTER I

HIGH EXPLOSIVES

FUSIBLE EXPLOSIVES

MIXTURES OF NITRO COMPOUNDS

WHEN picric acid was first used for filling shells by pouring it, in the molten state, difficulties arose due to its high melting point. The necessity of using superheated steam for melting was an added complication introducing the danger associated with the prolonged heating of the explosive to a high temperature.

Data from the Griesheim factory [1] show that this may be avoided by adding other aromatic nitro compounds, e.g. TNT, to the picric acid. The addition of even a small amount (5–10%) of such a substance facilitates melting without seriously decreasing the explosive power of the picric acid.

Easily fusible mixtures containing picric acid as the chief component were very widely employed in Russia and France during World War I and in the period immediately afterwards. A mixture of 51.5 or 80% picric acid with 48.5 or 20% dinitronaphthalene was used in the U.S.S.R. for filling aerial bombs and manufacturing demolition charges.

The composition of mixtures used in France is given in Table 44.

TABLE 44

COMPOSITION OF FUSIBLE EXPLOSIVE MIXTURES EMPLOYED IN FRANCE

Name of mixture	Composition, %					
	Picric acid	Dinitro- phenol	TNT	Trinitro- cresol	Nitro- naphtha- lene	Dinitro- naphtha- lene
MDN	80	—	—	—	—	20
MNN	70	—	—	—	30	—
MTTC	55	—	35	10	—	—
MDPC	55	35	—	10	—	—
Cresylite No. 2 (60/40)	40	—	—	60	—	—

Attempts were made in Britain to use mixtures of picric acid with dinitrobenzene. Maxim [2] suggested mixing picric acid with dinitronaphthalene or nitronaphthalene.

Kast [3] examined a number of readily fusible mixtures:

(1)	50 parts of picric acid 50 parts of trinitrocresol	} m.p. 80–83°C
(2)	55 parts of TNT 45 parts of DNT	
(3)	10 parts of TNT 90 parts of DNT	} begins to melt at 39°C } completely melts at 65°C

The use of a mixture of 35 parts of TNT and 65 parts of hexanitrodiphenylamine (hexyl) for filling torpedoes was introduced by the Germans in 1912. Hexyl, which is only very slightly soluble in molten TNT, on being heated to 80°C forms a suspension in the molten mixture; the resulting semi-fluid mass may be poured into the shells. During World War I this mixture was widely used for filling torpedoes, mines and aerial bombs. During World War II metallic aluminium was added (p. 266). As the raw materials during World War I grew more difficult to obtain, this material, when intended for aerial bombs, was mixed with ammonium nitrate to obtain a semi-fluid mass of the ammonal type. Where there was a lack of hexyl it was sometimes replaced by hexanitrodiphenyl sulphide and trinitroanisole was substituted for TNT. This led to the following mixtures:

- (1) 50% of TNT
50% of hexanitrodiphenyl sulphide
- (2) 50% of trinitroanisole
50% of hexanitrodiphenylamine
- (3) 50% of trinitroanisole
50% of hexanitrodiphenyl sulphide

These mixtures were poured into the shells as a molten mass usually containing a suspension of unmelted hexanitro compounds.

When toluene was in short supply TNT was partly replaced either by dinitrobenzene or by trinitronaphthalene. Thus the following mixtures were derived:

- (1) DiFp consisting of TNT and dinitrobenzene in various proportions
- (2) 65% of TNT
35% of trinitronaphthalene

During World War I, the Italians employed the following fusible mixtures:

- | | | |
|-----|--|---|
| (1) | MAT—60% of picric acid
40% of TNT | } begins to melt at 55–56°C
} completely melts at 85°C |
| (2) | MBT—60% of picric acid
40% of dinitrophenol | |

A more modern solution of the problem of fusible materials was given by Leitman [4] in the U.S.S.R. who developed "L-alloy", an explosive consisting of 95% TNT and 5% trinitroxylene melting at 74°C. L-Alloy has an explosive power

similar to that of TNT although it differs from the latter in detonating more readily due to the fact that during the cooling down process very fine crystals of TNT are formed in L-alloy.

During World War II the Germans partly replaced TNT either by trinitroxylyene or by a mixture of trinitroxylyene with TNT. The following mixture was the one most frequently used:

20% of trinitroxylyene	}	melts cloudily at 77°C
80% of TNT		

This mixture was prepared by the nitration of a mixture of nitrotoluenes with nitroxylenes.

Another mixture used as a substitute for TNT had the following composition:

45% of trinitroxylyene
5% of TNT
50% of tetryl.

It was prepared in a similar manner by nitrating a mixture of nitroxylenes with dinitromethylaniline and mixing it with TNT. This mixture melts at 80°C and is a more powerful explosive than TNT, but it requires a stronger detonator.

In the United States a fusible mixture of 70% tetryl and 30% TNT, Tetrytol, was used for demolition charges and land mines, since this mixture has a higher brisance than TNT and detonates more readily. The melting point of the mixture is 68°C. Cast mixture (solidified) has a density of 1.61–1.65, i.e. greater than that of TNT, thus making possible the use of charges stronger than those of TNT. Its rate of detonation is 7350 m/sec and in the ballistic pendulum gives a value of 120 (taking 100 for TNT). Its sensitiveness to impact by rifle bullet is a little higher than that of TNT. Its chemical stability at temperatures of 100–120°C is somewhat lower than that of tetryl, although specimens were successfully stored at 65°C for 2 years.

Mixtures with trinitroanisole have been employed in Japan; e.g. the 98 H₂ explosive, containing 60% of trinitroanisole and 40% of hexyl, which was used for filling bombs, torpedoes and depth charges.

During World War II cyclonite was used by all the combatants to increase the power of composite explosives. Fusible mixtures of TNT with cyclonite were prepared, mainly with an admixture of aluminium, and mixtures of TNT with hexyl and cyclonite also with admixture of aluminium (pp. 271–272).

In the United States a mixture of 60% cyclonite and 40% TNT was used under the name of Cyclitol as a filling for aerial bombs. The density of the cast explosive was 1.65–1.70, its rate of detonation 7800 m/sec, and in the ballistic pendulum it gave a value of 130 (100 for TNT). In the United States this mixture is considered to be only a little more sensitive to impact than TNT with a stability similar to that of cyclonite. This does not agree with T. Urbański's [5] investigations according to which the sensitiveness to impact of such a mixture, in a powdered form, and its ignition temperature (225°C) approximate to the corresponding values for tetryl.

Table 45 and the graphs in Figs. 65 and 66 summarize T. Urbański's findings on the rate of detonation, the lead block expansion, the sensitiveness to impact and the ignition temperatures of powdered mixtures of cyclonite with TNT, of various composition.

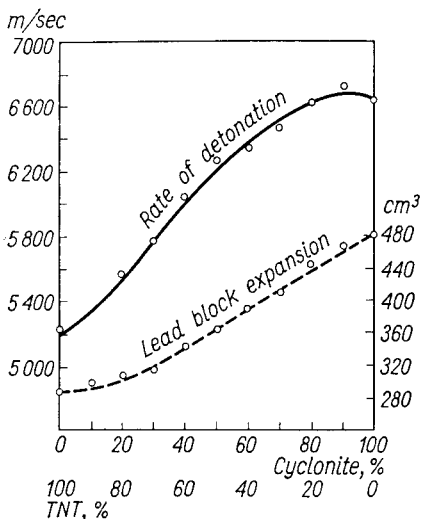

FIG. 65. The relation between the rate of detonation (density 1.04) and lead block expansion of mixtures of cyclonite and TNT, and their composition (according to T. Urbański [6]).

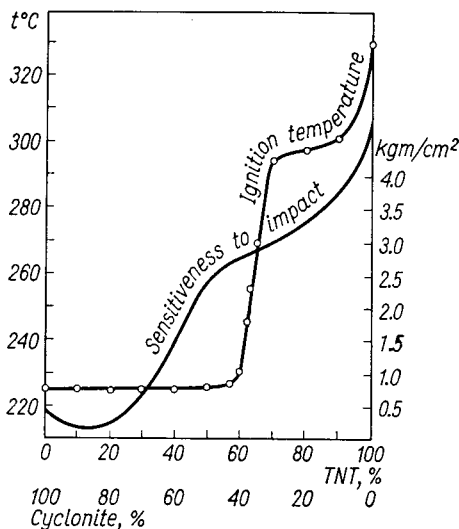

FIG. 66. The relation between the ignition temperature and sensitiveness to impact of mixtures of cyclonite and TNT, and their composition (according to T. Urbański [6]).

TABLE 45

EXPLOSIVE PROPERTIES OF MIXTURES OF CYCLONITE WITH TNT

Content of TNT %	Rate of detonation (at a density of 1.04) m/sec	Lead block expansion cm ³	Sensitiveness to impact (50% of explosions) kg/cm ²	Ignition temperature (10°/min) °C
0	6590	480	0.22	225
10	6710	465	0.16	225
20	6620	445	0.21	224
30	6460	410	0.42	225
40	6335	390	0.95*	225
50	6260	365	2.40	226
60	6035	345	2.50**	231
70	5770	315	2.60	295
80	5570	310	2.80	298
90	5260	300	3.35	302
100	5230	290	4.10	328

* Equals the sensitiveness of tetryl.

** Equals the sensitiveness of picric acid.

In Japan, the 94 M mixture consisting of 60% trinitroanisole and 40% cyclonite was employed for filling torpedoes and armour-piercing shells with hollow charges. Such a mixture solidifies with a density of 1.64, its rate of detonation being 7700 m/sec. In the United States a mixture of 75% HMX (Octogen) and 25% TNT was in use under the name of Octol.

During World War II PETN was also used, although to a lesser extent than cyclonite, since the former is more sensitive to impact and has a lower chemical stability. Mixtures of various compositions were employed according to their intended use. The most widely used mixture comprised 50% PETN and 50% TNT. This was employed in the molten state for filling hand and anti-tank grenades, and powdered and compressed, for filling detonators.

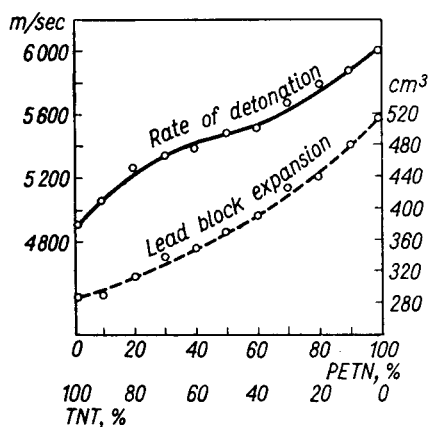

FIG. 67. The relation between the rate of detonation (density 1.04) and lead block expansion of mixtures of PETN and TNT, and their composition (according to T. Urbański [6]).

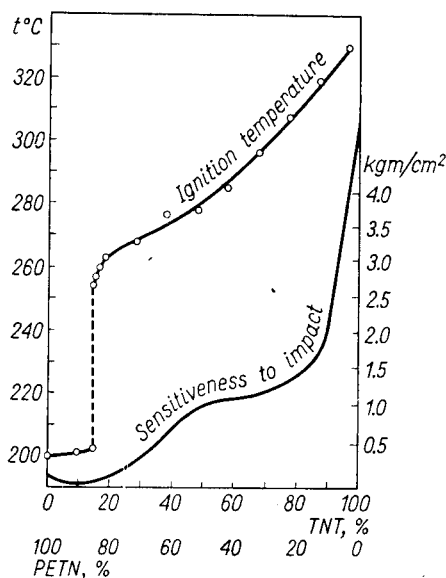

FIG. 68. The relation between the ignition temperature and sensitiveness to impact of mixtures of PETN and TNT, and their composition (according to T. Urbański [6]).

Mixtures of PETN with TNT are known as pentrolit or pentolit. Pentolit 50/50 has a density of 1.63–1.67; its rate of detonation is 7450 m/sec. It is highly sensitive to impact and its stability is lower than that of PETN alone (T. Urbański, Kwiatkowski and Miładowski [7]).

The rate of detonation, the lead block expansion, the sensitiveness to impact and the ignition temperatures of mixtures of PETN and TNT, according to T. Urbański [6, 8] and the rate of detonation according to Laffitte and Parisot [9] are presented in Table 46 and in the graphs shown in Figs. 67 and 68.

Williamson [10] examined the cast structure of various fusible or semi-fusible mixtures containing TNT as one component, the other being chosen from the following substances: ammonium nitrate, PETN, cyclonite and tetryl. The author also prepared casts of TNT alone. When dealing with mixtures of TNT and PETN or cyclonite, the author discovered that PETN and cyclonite recrystallize in suspension in molten TNT. This phenomenon leads to an increase in the size of the crystals of the suspended component (e.g. cyclonite) and, in consequence, reduces the fluidity of the semi-molten mass on heating. Sometimes, however, a TNT mixture containing cyclonite in suspension may become more fluid on heating. This occurs when cyclonite is present in the form of very small irregularly-shaped crystals. This is also caused by recrystallization which in a given case leads to the formation of a small amount of relatively large crystals without lowering the fluidity of the molten mass.

In the solidification of a TNT-tetryl mixture the author did not establish the presence of an addition compound of the two components in the solidified mass.

Viscosity — another important parameter of molten mixtures of TNT with cyclonite containing mainly suspended particles of RDX — was examined by a number of authors [11, 12]. The viscosity increases with increasing RDX content, viz.:

TABLE 46
EXPLOSIVE PROPERTIES OF MIXTURES OF PETN WITH TNT

Content of TNT %	Rate of detonation (at a density of 1.04, and 30 mm dia.) m/sec	Lead block expansion cm ³	Sensitiveness to impact (50% of explosions) kg/cm ²	Ignition temperature (10°/min) °C	Rate of detonation according to Lafitte and Parisot [9] (at a density of 1.0 and 8 mm dia.) m/sec
0	6005	515	0.20	200	5200
10	5870	480	0.15	201	5000
20	5785	440	0.22	262	4790
30	5675	425	0.42	267	4600
40	5510	390	0.80	275	4550
45	—	—	—	—	4680
50	5490	370	0.99*	277	4650
55	—	—	—	—	4950
60	5385	350	1.25	284	4400
70	5245	340	1.60	295	4100
80	5260	315	1.65	306	3720
85	—	—	—	—	3800
90	5050	295	1.75	317	3650
95	—	—	—	—	2050-3000
100	4865	290	4.10	328	—

* Equals the sensitiveness of tetryl.

RDX, % in 100 cm ³ of molten TNT	Viscosity cP
0	11.526
10	14.42
20	19.16
30	29.07
40	44.02
50	126.70

The rheological properties of the suspensions of RDX in molten TNT were studied by Koch and Freiwald [13].

MIXTURES WITH AMMONIUM NITRATE

There is another type of fusible mixture with ammonium nitrate as the chief constituent. These mixtures include substances which act as ammonium nitrate fluxes, lowering its melting point. Most of them are nitrates of various metals and various organic bases. Thus, Girard [14] by mixing equal amounts of guanidine nitrate and ammonium nitrate obtained a mixture, m.p. 140°C. In numerous later patents the following substances are mentioned as additives to ammonium nitrate: 10–20% of sodium nitrate and approximately 5% of other substances such as inorganic chlorides, urea, acetates or dicyandiamide.

Between 1914 and 1918 the Germans used the following mixtures:

(1)	No. 16	(2)	No. 20
	60–65% of ammonium nitrate		65–67% of ammonium nitrate
	10% of sodium nitrate		10–12% of sodium nitrate
	5% of dicyandiamide		3% of sodium acetate
	25–20% of TNT		20% of TNT

These mixtures melted at 105–110°C.

The Dynamit A.G. factory [15] patented a number of mixtures consisting of ammonium nitrate and nitrates of aliphatic amines, e.g.:

- (1) 55% of ammonium nitrate
45% of ethylenediamine nitrate
- (2) 60% of ammonium nitrate
40% of methylamine nitrate
- (3)* 55% of ammonium nitrate
40% of ethylenediamine nitrate
5% of methylamine nitrate

A different method for lowering the melting point of ammonium nitrate was suggested a few years before World War II. It consists of the addition of hydrated magnesium nitrate (i.e. containing water of crystallization) $\text{Mg}(\text{NO}_3)_2 \cdot 6\text{H}_2\text{O}$ to

ammonium nitrate. Due to the presence of the water of crystallization such mixtures melt at temperatures below 100°C (Boyd [16]).

Fusible mixtures with ammonium nitrate as the chief constituent were also manufactured and utilized in Germany during World War II under the name of S explosives.

In all explosives of this kind the fusible constituent of the mixture was ammonium nitrate with other nitrates, e.g. of sodium, potassium or calcium (with water of crystallization), of organic bases such as methylamine, ethylenediamine, guanidine etc. and urea. Since on solidification these mixtures become very dense and detonate with great difficulty, PETN, cyclonite or TNT were usually added. The composition of some of these mixtures is given in Table 47.

TABLE 47
COMPOSITION OF AMMONIUM NITRATE MIXTURES

Components	Mixtures			
	S-19	H-5	—	43C
Ammonium nitrate	73.3	50	50	45
Sodium nitrate	17.4	5	—	—
Potassium nitrate	—	—	—	—
Calcium nitrate $\text{Ca}(\text{NO}_3)_2 \cdot 4\text{H}_2\text{O}$	—	15	15	15
Ethylenediamine dinitrate	—	10	—	—
Guanidine nitrate	—	—	10	10
Urea	9.3	—	—	—
Cyclonite	—	20	25	—
TNT	—	—	—	30

The composition of similar mixtures, containing metallic aluminium, is given below in Table 56 (p. 271).

Manueli and Bernardini [17] proposed an easily fusible mixture consisting of ammonium nitrate, guanidine nitrate and nitroguanidine. According to them such mixtures may be melted at a temperature below 130°C. The explosive Albit, based on Manueli and Bernardini's patent, consisting of six parts of ammonium nitrate, two parts of guanidine nitrate and two parts of nitroguanidine, has been used in Italy.

Urbański and Skrzynecki [18] found that a eutectic formed by these three components solidifies at 113.2°C and contains:

- 60% of ammonium nitrate
- 22.5% of guanidine nitrate
- 17.5% of nitroguanidine

Le Roux [19] proposed the use of fusible mixtures of ammonium nitrate with tetramethylammonium nitrate (Vol. II, p. 466).

It was also suggested recently that fusible explosives should be used instead of semi-fusible ones. For this purpose TNT is replaced as a component by relatively low-melting nitric esters.

Médard [20], for instance, recommends a mixture of 62% ammonium nitrate and 38% trimethylolpropane trinitrate. Such a mixture has on oxygen balance corresponding to complete combustion. A charge with a diameter of 30 mm and a density of 1.50 detonates with a rate of 6150 m/sec, and a charge with a density of 1.10 detonates with a rate of 4230 m/sec. Its lead block expansion is 127.5 (taking picric acid as 100).

Its sensitiveness to impact is very low, lower than that of TNT.

A mixture of 40% ammonium nitrate and 60% trimethylolpropane trinitrate may be melted at 60°C and used as a poured filling for shells. The substance solidifies into a mass with a density of 1.36, giving a rate of detonation of 5200 m/sec.

MANUFACTURE AND SELECTION OF FUSIBLE MIXTURES

As a rule fusible mixtures are prepared in metallic kettles heated with steam or water jackets and fitted with stirrers, which are emptied either by tilting or through a valve placed in the bottom of the vessel.

In France mixtures containing picric acid were prepared in wooden tubs to avoid the formation of picrates. They were heated with live steam injected through an ebonite nozzle. After the mass has been mixed the steam supply was turned off and water was decanted from above the layer of nitro compounds by a glass syphon. The mixture was drawn off with wooden buckets in which it was cooled while being stirred continuously. The granular mass was then poured onto wooden trays where it was cooled further. Stirring was still continued during cooling, so as to produce granules approximately 10 mm dia.

It must be borne in mind that generally aromatic nitro compounds are not highly sensitive to impact and friction, but become more sensitive at elevated temperatures as they melt (changes in the sensitiveness of TNT are discussed in Vol. I, p. 319). If, therefore, a mechanical device is used for the preparation of mixtures by melting, its construction should be such as to exclude any possibility of friction or impact. It is probably best to use a converter heated with steam or water jackets and fitted with a stirrer that can be lifted out by a special arrangement. After the stirrer has been removed, the contents are poured out by tilting the vessel.

Fusible mixtures, with a composition having a suitable melting point, are selected by the thermal analysis of the two- and three-component system. Thermal analysis determines either the beginning and end of solidification or the beginning and end of the melting of the mixture.

To examine the possibility of using a given mixture for filling shells the changes in these temperatures are determined with mixtures of varied composition and it is established whether the components are eutectic mixtures or molecular compounds. The analysis also shows whether, in liquid phase, the components form a homogeneous system, solid solutions, etc.

In fact, the presence of solid solutions considerably effects the homogeneity of the mixture, preventing the formation of inner cracks and fissures. If the solidifying point of the eutectic is too low (i.e. below 60°C) the explosive may exude from the shell, whereas too high a solidifying point hinders melting, and in turn complicates the process of filling the shell.

The literature on thermal analysis of mixtures either deals with purely theoretical studies of the formation of molecular compounds, solid solutions, etc., e.g. Kremann's [21, 22] work, or describes the search for materials of immediate practical value.

Research relating to practical matters has two aims:

(1) To determine the contents of various isomers in nitration products. Such studies include the work of Giua [23] on systems consisting of DNT and TNT isomers, those of Pascal [24] on systems consisting of dinitro- and trinitronaphthalene isomers, and those of Andrews [25] and of Wyler [26] on systems consisting of dinitrobenzene isomers. The graphs obtained by these authors may be helpful when studying the composition of nitration products.

(2) To decide whether a given mixture is suitable for filling shells or for producing non-freezing dynamites. Thermal analysis of the components of mixtures in practical use, e.g. nitroglycerine and centralite, fulfils a similar, practical aim by explaining the interaction of these substances, in particular whether they form simple eutectics, molecular compounds or solid solutions.

Studies of this kind which include a number of papers mentioned in corresponding sections of this book, are recommended for reference. They are concerned with the following substances:

(a) Mixtures containing aromatic trinitro compounds:

Yefremov *et al.* [27, 28] (systems containing TNT, picric acid, trinitrocresol, trinitroresorcinol, tetryl, trinitroxylene etc.); Wogrinz and Vári [29] (systems containing TNT and picric acid); C. A. Taylor and Rinkenbach [30] (systems containing TNT, picric acid and tetryl); Jovinet [31] (the system: picric acid-nitronaphthalene); Hrynakowski and Kapuściński [32] (systems containing TNT and picric acid); T. Urbański and Kwiatkowski [33] (systems containing picric acid and dinitronaphthalenes).

(b) Mixtures containing nitroglycerine: Tamburrini [34], Kurita and Hagui [35], Médard [36], and Hackel [37].

(c) Mixtures containing PETN: T. Urbański [38] and Desseigne [39].

(d) Mixtures containing cyclonite: T. Urbański and Rabek-Gawrońska [40].

Khaibashev and Bogush [41] examined ternary systems containing cyclonite. They discovered eutectic mixtures of the following compositions:

- | | | | |
|-----|-------|-----------------------------|-------------|
| (1) | 82% | of <i>m</i> -dinitrobenzene | |
| | 9% | of cyclonite | m.p. 80.5°C |
| | 9% | of trinitroxylene | |
| (2) | 74.5% | of <i>m</i> -dinitrobenzene | |
| | 7% | of cyclonite | m.p. 74.5°C |
| | 18.5% | of 1,8-dinitronaphthalene | |

(e) Mixtures of guanidine nitrate, nitroguanidine and ammonium nitrate: T. Urbański and Skrzynecki [18].

(f) Three-component mixtures of inorganic nitrates: T. Urbański and Kołodziejczyk [42] established the existence of a eutectic of the following composition:

66.5% of NH_4NO_3	
21.0% of NaNO_3	f.p. 118.5°C
12.5% of KNO_3	

THE PHEGEMATIZATION OF FUSIBLE MIXTURES

Even by the end of the nineteenth century it had become clear that some explosives safe to handle in principle (e.g. picric acid), are nevertheless too sensitive to the impact that occurs when the projectile containing them strikes against heavy armour plate. Attempts were made therefore to decrease this sensitiveness by desensitization, or "phlegmatization" of the explosive.

In France, picric acid intended for armour-piercing shells was phlegmatized with paraffin. MP (mélinite paraffiné) mixture, containing 88% of picric acid and 12% of paraffin, was chosen for this purpose. Paraffin desensitizes picric acid, making it less sensitive than TNT. Since paraffin is insoluble in molten picric acid, the mixture is prepared by melting the paraffin in an aluminium kettle, heating it to 100°C and adding powdered picric acid while stirring with a wooden paddle. The granules so formed are transferred to a table, rolled out and mixed by rubbing several times through a sieve.

Paraffin, however, is not a good phlegmatizing agent. It was discovered that higher fractions of crude oil, with a waxy consistency, and composed of more polar molecules, are considerably more effective so that desensitization may be achieved by using a smaller amount of phlegmatizing substance. This is decidedly preferable since too large an admixture of a phlegmatizing substance weakens the explosive.

Montan wax, widely used in Germany, is a better phlegmatizing agent than paraffin. Hence before and during World War I German naval armour-piercing shells were filled with TNT, desensitized by 6% of montan wax.

During World War II PETN, desensitized by 10% (sometimes 5 or 15%) of montan wax was employed for small shells (e.g. 20 mm) in Germany.

The mixing of TNT or PETN with montan wax is usually carried out under water at a temperature above the melting point of wax (70°C). With TNT the temperature should be maintained below 80°C; with PETN the whole is heated to 95°C and vigorously agitated so that the phlegmatizing substance is dispersed. The whole is then cooled to 30–35°C, while still being agitated. The granules and crystals of the explosive, coated with a layer of wax, are filtered off and dried at 60–65°C. A detailed description of PETN phlegmatization is given in Vol. II, p. 189.

The inclusion of wax-type phlegmatizing substances in the mixture facilitates the pressing of the explosive as it decreases the friction between the crystals. Thus a mixture with a higher density can be obtained by applying a lower pressure.

Non-explosive substances which, when molten, act as solvents for explosives, are another type of desensitizing agents. For instance, pentaerythritol tetra-acetate was suggested by Bombrini-Parodi Delfino [43] as a phlegmatizer of PETN.

The phlegmatization of PETN with nitronaphthalene recommended by T. Urbański [6] is based on the same principle of the partial dissolution of PETN. A mixture of PETN plus 20% nitronaphthalene has approximately the same sensitiveness to impact as tetryl, and with 40% nitronaphthalene the same sensitiveness to impact as picric acid.

Chlorofluoropolymers of the Kel and Exon types are now used in the U.S.A. as modern phlegmatizers of cyclonite, e.g.

90/10 RDX/Kel F 3700 in granules 0.8–1.4 mm dia.

94/6 RDX/Exon 461 in granules *ca.* 0.3 mm dia.

Nitrocellulose dissolved ("gelatinized") with phosphoric acid esters can also be used to produce a granulated and partly desensitized nitramine explosives, e.g. a mixture:

94/3/3 HMX/NC/tris(β -chloroethyl)phosphate with 0.1% diphenylamine as stabilizer, in granules 1–7 mm dia. [44].

Phlegmatizing compounds in chlorate, and perchlorate explosive mixtures play a special role since they are essential as a combustible constituent. They are discussed in more detail on pp. 274–280.

SEMI-FUSIBLE AND INFUSIBLE EXPLOSIVES

The molecular composition of picric acid was established in the early nineteenth century when it was the only highly-nitrated aromatic compound then known. It was evident that its oxygen content was insufficient for complete combustion (to CO_2 and H_2O). This was considered to be an adequate foundation for the erroneous theory that, because of its insufficient oxygen content, the substance has no explosive properties. It was believed that explosive properties are achieved only by mixing picric acid with oxidizing agents such as chlorates, or sodium or potassium nitrates.

These mixtures found no practical application since picric acid gradually reacts with salts to form picrates with the evolution of free acid. The picrates so formed are highly sensitive to friction and impact, and the free acid acts corrosively. Mixtures with chlorates showed a particular sensitiveness to friction and impact, hence doubt was expressed as to their practical value. Nevertheless, the idea of completing the defective oxygen balance in aromatic nitro compounds by the addition of such oxidizing agents as nitrates was carried out in such a way as to produce mixtures useful for various practical purposes.

Cheltsov [45] obtained (1886) a stable explosive, suitable for storage, called Gromoboi or Maizit, by mixing ammonium picrate with ammonium nitrate in the ratio of 72.5 : 27.5.

To achieve the necessary stability he used its ammonium salt, which has no acidic properties instead of picric acid.

The same principle has been employed in some countries (e.g. U.S.A.) to produce the explosives in which the chief component was ammonium picrate together with ammonium nitrate.

There have also been interesting and promising attempts to use ammonium nitrate as a component of high explosives. Particularly noteworthy are the experiments in which potassium nitrate in blackpowder is completely or partially replaced by ammonium nitrate to improve brisance. This led to the ammonium nitrate mixtures, Ammonpulver M90 and M96, 15/85 mm. They were employed in Austria for filling shells at the end of the nineteenth century but were not used for long, due to the difficulty of detonating them.

Ohlsson and Norrbin [46] suggested another type of ammonium nitrate explosive for mining purposes (see p. 395).

With the development of the organic chemical industry, aromatic nitro compounds of the TNT type were introduced as ingredients of composite explosives. TNT is preferable to picric acid since it has no acidic properties and hence is much less reactive. Mixtures with TNT and similar nitro compounds showed an excellent chemical stability.

High explosive mixtures with potassium and sodium chlorates or potassium and ammonium perchlorate belong to a separate group; a mixture of these salts with any combustible used in a suitable quantity will act as an explosive.

MIXTURES WITH NITRATES—MAINLY WITH AMMONIUM NITRATE

Mixtures of aromatic nitro compounds with ammonium nitrate were widely used during World War I, when the enormous demand for high explosives could not be met by the output of TNT, trinitronaphthalene, picric acid, trinitroanisole, trinitrophenetole, dinitrobenzene, hexyl etc.

Ammonium nitrate, which was then being manufactured from atmospheric nitrogen for the first time, is the most readily available explosive ingredient, and all the more valuable since on decomposition it leaves no solid residue and ensures a great volume of gaseous explosion products. Its great disadvantage lies in its high hygroscopicity but this is unimportant if the explosive charge is tightly packaged.

The explosive properties of mixtures with ammonium nitrate depend on the quantitative relationship between the oxidizing agent and the explosive or combustible substance. According to Parisot and Laffitte's [9, 47] investigations the explosive properties of mixtures of aromatic nitro compounds with ammonium nitrate vary with the change in composition of the system in an almost rectilinear manner. The graph in Fig. 69 shows how the rate of detonation depends on the composition of mixtures of tetryl or picric acid with ammonium nitrate. T. Urbański *et al.* [48] also obtained a rectilinear relationship for nitrostarch mixtures with ammonium or sodium nitrate (Fig. 71, p. 265).

The sensitiveness to impact of mixtures of nitro compounds with ammonium nitrate is higher than that of pure nitro compounds due to the friction produced by the hard crystals of the ammonium nitrate. This was established for TNT mixtures with ammonium nitrate by Hackel [49] (c.f. pp. 262-263).

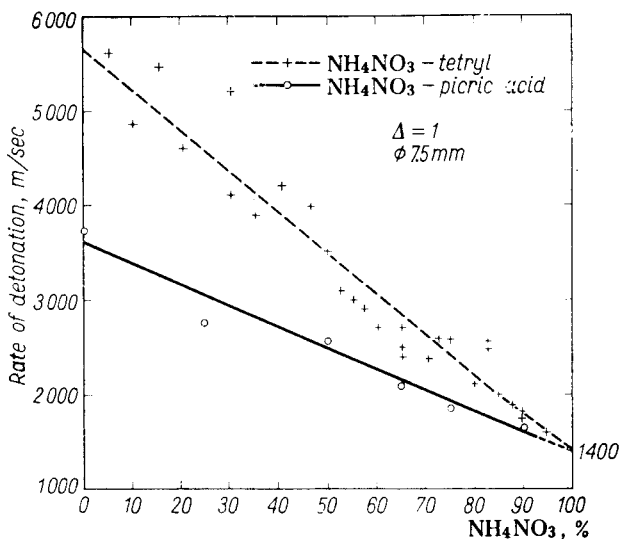

FIG. 69. The relation between the rate of detonation and the composition of tetryl or picric acid mixtures with ammonium nitrate (Parisot and Laffitte [9]).

One of the most widely used mixtures comprised ammonium nitrate with dinitronaphthalene in a ratio giving complete decomposition with a zero oxygen balance:

87.5% of ammonium nitrate
12.5% of dinitronaphthalene

This mixture was used extensively during World War I for filling artillery shells in France (under the name of Schnéiderite), Italy and Russia. The spelling "sznajderyt" was adopted in Poland and "shneiderit" in the U.S.S.R.

Schnéiderite may detonate at a density of 1.30 with a rate ranging from 3815-5840 m/sec, depending on the way the ingredients are mixed. It is used either as a powder pressed into shells with an initiating charge of TNT (called SCPT-explosive in France) or as granules obtained by breaking up the pressed cake. The granules are poured into the shells and the spaces between filled with molten TNT. In France this kind of explosive bore the symbol STF.

This explosive used in France and Russia had the composition

78% of ammonium nitrate
22% of dinitronaphthalene

During World War II these substance were not widely employed, being relatively weak explosives; they are not so valuable in this respect as similar TNT mixtures.

TNT mixtures with ammonium nitrate were in common use during the World Wars I and II in Germany and Great Britain. The mixture consisting of:

40% of ammonium nitrate
60% of TNT

acquired considerable importance. It was known in Germany as Fp 60/40 (Füllpulver 60/40) and in Britain as Amatol 40/60. It was heated to a temperature above the melting point of TNT and then poured into shells as a semi-molten mass. Due to the shortage of TNT in Germany during World War I originally a part, and then the whole of the TNT in this mixture was replaced by dinitrobenzene. This resulted in the mixture DiFp 60/40 with the following compositions:

40% of ammonium nitrate
60% of dinitrobenzene or a TNT mixture
with dinitrobenzene

The Germans also used a similar mixture containing trinitroanisol instead of TNT for filling aerial bombs. In Britain other Amatols were also employed, i.e. ammonium nitrate mixtures with TNT in various ratios (Table 48).

TABLE 48
COMPOSITION AND PROPERTIES OF AMATOLS

Name	Composition		Consistency	Properties		
	NH ₄ NO ₃	TNT		Density	Rate of detonation m/sec	Lead block expansion cm ³ (TNT = 290 cm ³)
Amatol 40/60	40	60	Semi-molten when hot Can be cast	1.54–1.59	6470–7440	320–350
Amatol 45/55	45	55				
Amatol 50/50	50	50		1.56	7020	340–360
			1.60	5850*		
Amatol 60/40	60	40		1.50	6060**	
				1.60	5600*	350–370
Amatol 80/20	80	20	Loose powder, plastic when hot	1.46–1.50	5080–5920*	370–400
				1.60	5200*	

* According to Evans [50].

** In a steel tube 17 mm dia. according to Copp and Ubbelohde [51].

Amatol 80/20 is a mixture approaching the proportion in which all the oxygen contained in ammonium nitrate is used (the oxygen balance is +1.2% in Amatol

80/20). This is a free-flowing mixture when cold. It is usually stemmed or extruded into the shells by means of a screw wheel (worm wheel).

Amatols 50/50 and 60/40 were loaded into shells as substitutes for Amatol 40/60, in a semi-molten state obtained by heating to above the melting point of TNT.

Semi-fusible mixtures which contain 40–60% of nitro compounds tend to separate out after the nitro compound has been melted. During World War II these mix-

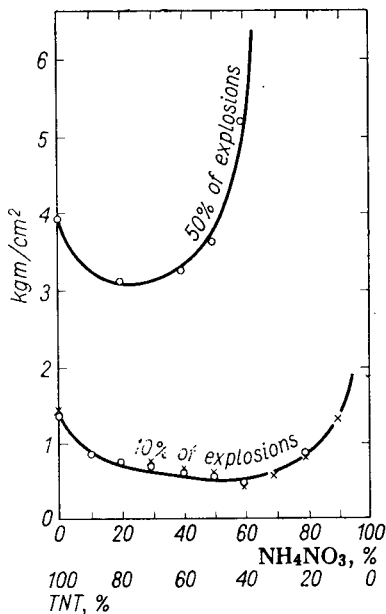

FIG. 70. The sensitiveness to impact of TNT mixtures with ammonium nitrate. Curves of probability of 10 and 50% explosions (Hackel [49]).

tures were used for filling large aerial bombs. To prevent stratification of the ingredients (the separation of crystals of ammonium nitrate) emulsifying substances were added to the mixtures.

TNT mixtures with ammonium nitrate are more sensitive to impact than TNT itself. As shown by Hackel [49] (Table 49 and Fig. 70) mixtures containing 30–60% of ammonium nitrate are equally as sensitive as picric acid. Mixtures of this kind should not, therefore, be used for filling high initial velocity heavy calibre shells, e.g. armour-piercing shells.

Amatols in the form of cast charges detonate more readily than TNT in the same form. Initially, it was believed that the size of the ammonium nitrate crystals influences the ease of detonation, viz. that finely ground ammonium nitrate facilitates detonation.

Hackel [52], however, made it clear that in Amatols the ease of detonation also depends on the size of the crystals of the solidified TNT and increases in proportion

TABLE 49

SENSITIVENESS TO IMPACT OF TNT MIXTURES WITH AMMONIUM NITRATE (ACCORDING TO HACKEL)

Composition of mixture		Sensitiveness to impact. Impact of a 5 kg weight causing 10% of explo- sions, kgm/cm ²
TNT %	Ammonium nitrate %	
100	0	1.37
90	10	0.85
80	20	0.74
70	30	0.71
60	40	0.64
50	50	0.57
40	60	0.48
30	70	0.53
20	80	0.81
10	90	1.27

to the decrease of size of the crystals (i.e. in proportion to the rate of the cooling of the explosive).

During World War II Amatols of increased explosive power, in which a part of the ammonium nitrate was replaced by cyclonite, were also used. Thus German Ammonals were evolved from Amatol 50/50. Dinitrobenzene was used in Amatols 39a and 40 (Table 50) as a substitute for TNT.

TABLE 50

COMPOSITION OF AMATOLS WITH CYCLONITE

Ingredients	Amatol 39	Amatol 39a	Amatol 40
TNT	50	—	—
Dinitrobenzene	—	50	50
Cyclonite	5-10	15	10
Ammonium nitrate	40-45	35	40

The mining explosive Donarit was first used for filling hand grenades and manufacturing demolition charges during World War I. It consisted of

- 80% of ammonium nitrate
- 12% of TNT
- 4% of nitroglycerine (gelatinized with collodion cotton)
- 4% of wood flour

Due to the presence of nitroglycerine, this material was found to be too sensitive to mechanical impulses (it exploded when struck by a 2 kg weight falling 30 cm).

Kast [3] therefore proposed, as an alternative, an explosive called Perdit which consisted of:

72% of ammonium nitrate
 10% of potassium perchlorate
 15% of liquid DNT
 3% of wood flour

This material gives a lead block expansion of 380 cm³. It was employed widely up to the end of the World War I not only for hand grenades and demolition charges, but also for filling shells with a low muzzle velocity.

Apart from composite explosives with ammonium nitrate, mixtures with other nitrates also acquired temporary significance, e.g. a mixture used in Russia during World War I for filling hand grenades had the following composition:

60% of TNT
 35% of potassium nitrate
 4% of ammonium nitrate

and Baratol, employed in Britain during both World Wars, consisting of TNT and barium nitrate in the ratio of 40 : 60.

An explosive called Macarit with a composition recommended by Macar [53]:

28% of TNT
 72% of lead nitrate

also achieved some importance before World War I.

A similar substance under the name of Piombitto was used in Italy at the same time for filling artillery shells.

During World War I, in the United States Trojan Explosive was widely employed for filling hand grenades and mortar bombs. Its explosive constituent was nitrostarch:

23-27% of nitrostarch
 31-25% of ammonium nitrate
 36-40% of sodium nitrate
 1.5-2.5% of charcoal
 0.5-1.5% of lubricating oil
 0.5-1.5% of calcium carbonate or magnesium oxide
 0.2-0.4% of diphenylamine
 0-1.2% of water

Since this explosive is infusible it was loaded by ramming down with a wooden plug. Grenite was another granulated nitrostarch material for filling hand grenades, consisting of 97% nitrostarch with lubricating oil (1.5%) and gum arabic (1.5%) as granulating materials.

The explosive properties of nitrostarch mixtures (containing 12.7% of nitrogen) with ammonium or sodium nitrates have been studied by T. Urbański *et al.* [48]. Values for rate of detonation of mixtures with a density of 1.0 are given in Fig. 71. They conform to Laffitte's rule that the variation in rate of detonation with the composition of mixtures with ammonium nitrate is almost rectilinear.

Other examples of infusible explosives are the Ammonites with the composition shown in Table 51.

A shortage of ammonium nitrate in Germany (from 1944) led to the use of a TNT mixture with 40% of sodium nitrate and later even with 50–60% of sodium chloride for shell filling as cast charges. Sodium chloride was used merely to keep the right charge weight.

Sometimes sodium and potassium silicates were used instead of sodium chloride. Thus the consumption of TNT did not need to be increased while the consistency

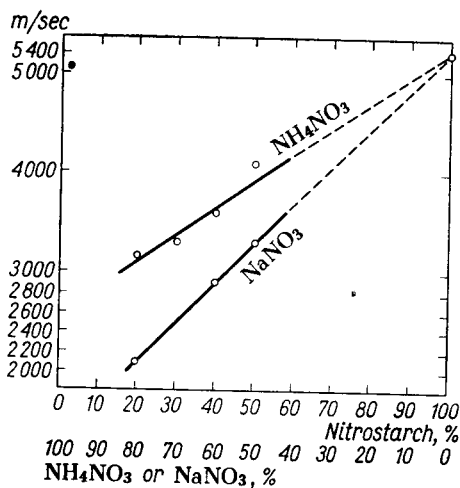

FIG. 71. The rate of detonation of nitrostarch mixtures with ammonium or sodium nitrates (according to T. Urbański *et al.* [48]).

and density of Amatols were maintained in mixtures which in turn averted the necessity for the alteration of the design of shells and the method of filling. Such mixtures were used to the same extent as Amatols for filling shells, bombs and hand grenades. It is obvious that they were of little value.

TABLE 51

THE COMPOSITION OF AMMONITES

Ingredients	H-1	H-8
Ammonium nitrate	50	50
Potassium nitrate	—	25
Calcium nitrate (4H ₂ O)	15	—
Cyclonite	25	15
PETN	10	10

In Japan explosive consisting of 60% of trinitroanisole and 40% of ammonium nitrate was manufactured and used for filling bombs.

During World War II a mixture of TNT (48%) with ammonium picrate (52%) known as Picratol was employed to replace pure ammonium picrate (Explosive D) in the United States. This was a semi-fusible mixture cast into shells at a temperature above the melting point of TNT. After solidification the density of the mixture was 1.62. In accordance with the opinion prevailing in that country that ammonium picrate is an explosive with a low sensitiveness to impact, it was used for filling armour-piercing shells.

Various loose powder mixtures of ammonium picrate and aluminium were also used by the Japanese during World War II. They will be dealt below, as mixtures with aluminium.

The preparation of infusible (loose powder) ammonium nitrate mixtures is usually carried out in the same way as the manufacture of composite mining explosives. Since the military explosives are not very sensitive to mechanical stimulants, and it is important to obtain a high density, mixing is usually performed by edge runner mills.

The mixing of semi-fusible explosives is commonly carried out in kneaders, first heating the ammonium nitrate to a temperature of 85–90°C and then pouring in the molten TNT. After stirring, the material is cooled down in the kneader to produce a mixed crystalline mass.

MIXTURES WITH ALUMINIUM AND OTHER METALS

The addition to an explosive of combustibles which burn with very great evolution of heat is advantageous in spite of the fact that the oxygen balance is impaired. The heat of explosion so obtained is very great and the temperature of the explosion products is very high.

The following metals have been suggested for this purpose: magnesium, aluminium, zinc and also silicon; sometimes ferro-silicon, aluminosilicon and calcium silicide are also employed. Deissler [54] was the first (1897) to recommend aluminium as a component of explosives. He was followed by Goldschmidt [55], Escales [56], von Dahmen [57] and Roth [58]. In later years Kast [59] investigated military explosives which contained aluminium.

Magnesium and zinc are readily oxidized, and are liable to undergo oxidation during the storage of mixtures containing them, hence they have not been utilized for military purposes. Apart from this, magnesium is a valuable component of various pyrotechnic mixtures such as those used in signals or for illumination, for which it is hard to find a substitute. With the exception of calcium silicide the silicon alloys burn with more difficulty and are less efficient. For this reason aluminium and calcium silicides are the most widely used.

Originally aluminium was employed in the form of fine powder ("aluminium bronze"). It appeared later that such a high degree of sub-division is unnecessary and good results may also be achieved with aluminium filings, shavings and especially

flakes. The latter form is particularly advantageous as the smaller total surface of aluminium present with mixture slows down the rate of oxidation during storage.

In explosives in which there is no surplus of oxygen, aluminium reacts initially with carbon dioxide formed as an explosion product, according to the equation:

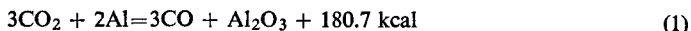

The heat effect of this reaction is very great and it makes a big contribution to the general heat balance.

Originally the addition of aluminium was limited to explosives with a positive oxygen balance, i.e. mixtures containing a considerable amount of an oxygen carrier. However, during World War II, the Germans extended the use of aluminium by adding it to nitro compounds, for example to a mixture of TNT with hexyl.

It might seem paradoxical to add aluminium to such explosives, as it would result in a large reduction of volume of the gases:

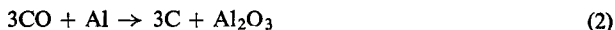

However, under the very high pressures prevailing during detonation, the carbon monoxide decomposes in part into carbon dioxide and carbon. Aluminium reacts with carbon dioxide according to eqn. (1) and with water according to eqn. (3):

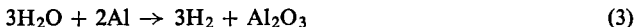

This would develop a considerable heat. Thus, replacing 15% of TNT-hexyl with aluminium would increase the heat of detonation from *ca.* 1000 kcal/kg to *ca.* 1400 kcal/kg [60].

In military ammonium nitrate explosives containing aluminium even those in which the oxygen balance is negative, the main reaction is assumed to be that of oxidation of the aluminium by reaction with ammonium nitrate:

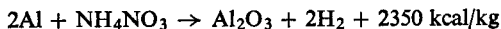

The gas volume is 502 l./kg and calculated explosion temperature 5400°C. It is also possible that aluminium reacts with nitrogen to form aluminium nitride (Al_2N_2). The reaction is also exothermic ($-\Delta H = 80$ kcal). (The work was done at the Chemisch-Technische Reichsanstalt in Germany in the period between the two World Wars [61].)

The mixtures containing the oxidizing agent, e.g. ammonium nitrate and aluminium were termed Ammonals.

The system: ammonium nitrate, aluminium, nitro compound (e.g. TNT) would be expected to undergo gradual decomposition, e.g. that in stored shells and bombs filled with such mixtures changes would occur, leading to the oxidation of the aluminium. Obviously, a mixture containing oxidized aluminium has lower explosive power than the same mixture containing metallic aluminium. It was therefore very important to determine the mechanism of the oxidation of aluminium. It became apparent that this is caused by impurities in the ammonium nitrate, not by the

ammonium nitrate itself. Chaylan's [62] experiments showed that mixtures of pure ammonium nitrate, TNT and aluminium are stable within the temperature range of 60–95°C, and at 100°C, after 1000 hr of heating, only a few cm³ of gas are evolved. Experience has shown that traces of chlorides in ammonium nitrate should be avoided as they can induce aluminium to react even at room temperature. Aluminium also undergoes a corrosion reaction which is caused by the metallic walls of the shell, and which has not yet been fully explained. In all probability its origin is electrochemical. Other data show that aluminium reacts with copper alloys.

It is well known that ammonium nitrate evolves ammonia on storage, particularly in the presence of moisture. It was found that the amount of ammonia evolved in the presence of aluminium is much greater [63]. The evolution of ammonia is particularly undesirable in the mixtures containing TNT, as TNT reacts with ammonia to yield readily ignitable compounds (Vol. I, p. 304; see also [64]).

According to Aubertein [65] aluminium particles used as a component in explosives may be coated with 2–8% of paraffin, mineral oil or resin to prevent premature reaction with other ingredients.

Ammonals were originally intended for use in mines. In Austria [66] for instance, ammonals with the following composition were used in gas-free mines:

80–90% of ammonium nitrate
4–6 % of charcoal
4–18% of aluminium

Soon afterwards, however, the use of ammonals in collieries was forbidden and their utilization restricted to above ground operations, e.g. quarrying. During World War I ammonals were extensively used for this purpose.

Ammonal was used to a certain extent in Russia and Great Britain. Its composition was as follows:

65% of ammonium nitrate
15% of TNT
17% of aluminium
3% of charcoal

The presence of charcoal, however, proved to be unnecessary; during World War I Russian mines were loaded with ammonal made without it:

7.65% and 68% of ammonium nitrate
16.0% and 15% of TNT
7.5% and 17% of aluminium

Detonators for initiating a Schnéiderite charge in Russian shells were also filled with an aluminium mixture:

65% of ammonium nitrate
15% of TNT
20% of aluminium

According to Förg [66] even before 1914 T-Ammonal manufactured by the G. Roth factory at Felixdorf was employed for filling artillery shells in Austria. The composition of this explosive was as follows:

45% of ammonium nitrate
 30% of TNT
 23% of aluminium
 2% of "red" charcoal (p. 345)

Kast [3] gives for this substance the following figures as characteristic of its explosive power:

Heat of explosion 1465 kcal/kg
 Gas volume (V_0) 605 l/kg
 Temperature of explosion 4050°C
 Specific pressure (f) 9900 m
 Rate of detonation in an iron pipe at a density of
 1.62 5650 m/sec
 Lead block expansion 470 cm³

In Germany "Deutsche Ammonal" was used for filling large calibre shells. Various ammonals were employed to an appreciable extent for filling bombs, land mines in Italy and to a lesser extent in France. The composition of these explosives is represented in Table 52.

TABLE 52
 COMPOSITION OF AMMONALS

Ingredients	Italian ammonals		Belgian Sabulite	French	British	German
	Nitramit	Echo				
Ammonium nitrate	72	62	78	65	64	54
TNT	—	—	8	15	15	30
Nitrocellulose	—	5.5	—	—	—	—
Paraffin	6	—	—	—	—	—
Animal grease	—	7.5	—	—	—	—
Charcoal	—	—	—	10	3	—
Aluminium	22	25	—	—	18	16
Calcium silicide	—	—	14	10	—	—

Ammonals containing a little or no TNT detonated with difficulty and were therefore not pressed but rammed down to a relatively low density. For the same reasons their use was restricted to the shells with a low muzzle velocity. Shells with a high muzzle velocity were loaded by pressing with ammonals rich in TNT (T- or German ammonals). Ammonals were also used when a high brisance was required, e.g. for filling torpedoes.

A few other simple German ammonals containing ammonium nitrate were used for shell filling during World War II. Their composition is given in Table 53.

TABLE 53
COMPOSITION OF GERMAN AMMONALS

Ingredients	Fp* 19	Fp* 13-113	Fp* 110
Ammonium nitrate	35	70	90
TNT	55	20	—
Naphthalene	—	—	5
Wood meal	—	—	2.5
Aluminium	10	10	7.5

* Fp stands for Füllpulver.

The compositions of American ammonals are collected in Table 54.

TABLE 54
COMPOSITION OF U.S. AMMONALS

Ingredients	1	2	3
Ammonium nitrate	22.0	72.0	65.0
TNT	67.0	12.0	added 15.0
Aluminium (fine powder)	11.0	16.0	16.0
Aluminium (coarse grain)	—	—	16.0
Charcoal	—	—	3.0

During World War I another type of explosive —“Mischpulver”—was used by the Germans for filling hand grenades. This was blackpowder mixed with potassium perchlorate and aluminium. The mixture consisted of:

83% of blackpowder
12% of potassium perchlorate
5% of aluminium

The presence of perchlorate and aluminium conferred high explosive properties on the mixture.

Perchlorate ammonal was also used in Britain for filling land mines. It consisted of:

78% of ammonium perchlorate
16% of paraffin
6% of aluminium

After World War I the use of ammonals was restricted to quarrying: in coal mines they were banned since their high flame temperature (due to presence of metallic aluminium) makes them inherently dangerous there.

In Spain during the Spanish Civil War, General Franco's forces used Ammonal I composed of [63]:

92.4% of ammonium nitrate
6.6% of charcoal
1.0% of aluminium

During World War II the use of aluminium in military explosives was resumed on a wide scale. Thus sea mines and German torpedoes were loaded with a fusible mixture of hexyl and TNT supplemented by 10–25% of metallic aluminium (Trial).

TNT was partly replaced by dinitronaphthalene in the KMA mixture. Alternatively, hexyl was replaced by dinitrophenylamine to form fusible S-6 mixtures.

TABLE 55
COMPOSITION OF KMA AND S-6 MIXTURES

Ingredients	KMA	S-6	S-6 modified
TNT	40	40	30
Dinitronaphthalene	20	—	—
Hexyl	30	30	30–35
Dinitrodiphenylamine	—	20	15–20
Aluminium	10	10	15–25

Haid in the Chemisch-Technische Reichsanstalt in Berlin suggested [67] substitute fusible mixtures of the S-type which were introduced towards the end of World War II owing to the shortage of nitro compounds. Their composition is given in Table 56.

TABLE 56
COMPOSITION OF S-TYPE SUBSTITUTE MIXTURES

Ingredients	S-16	S-19 (modified)	S-22 (with cyclonite)	S-22 (with hexyl)	S-26 (with hexyl)
Ammonium nitrate	32	55	44	44	55
Sodium nitrate	6–8	9	9	9	9
Potassium nitrate	0–2	4.2	3	3	4.2
Ethylenediamine dinitrate (PH-Salz)	10	—	14	14	—
Urea	—	1.8	—	—	1.8
Hexyl	—	—	—	15	15
Cyclonite	10	15	15	—	—
Aluminium	40	15	15	15	15

For filling V2 missiles Trialen, a mixture of TNT, cyclonite and aluminium, was used in Germany.

Another German explosive, Hexal, consisted of:

71% of cyclonite
4% of montan wax
25% of aluminium

The moulded slabs of this explosive were cast into the shell and the spaces between them was filled with a fusible mixture, e.g. KMA.

In Great Britain a cast explosive Torpex was developed during World War II. It was composed of 41% of RDX, 41% of TNT and 18% of aluminium. It was used for filling torpedoes and bombs.

Due to the sensitiveness of Torpex a few modifications were developed, as for instance the cast explosives DBX and HBX [68] (Table 57).

TABLE 57

Ingredients	DBX	HBX
RDX	21	39.6
TNT	40	37.8
Ammonium nitrate	21	—
Aluminium	18	17.1
Desensitizer	—	5.0
Calcium chlorate	—	0.5
Density	1.68	—

In the U.S.A. Tritonal, a cast mixture of 80% TNT and 20% aluminium was used. It gave a density of 1.73 [68].

In Japan a cast mixture composed of 60% of trinitroanisole and 40% of aluminium was used for filling high explosive incendiary shells. On solidification this mixture has a density of 1.90.

E-4, an infusible ammonium nitrate explosive was composed of:

- 44% of ammonium nitrate
- 10% of sodium nitrate
- 2% of urea
- 14% of hexyl
- 30% of aluminium

During World War II the Japanese employed mixtures with aluminium or ferro-silicon. Some examples of these are tabulated below (Table 58).

Recently The Dow Chemical Company (Midland, Michigan) developed a powerful new plastic explosive MS-80 containing 20% aluminium. No details on the composition are available [69].

TABLE 58

MIXTURES WITH ALUMINIUM AND FERRO-SILICON

Ingredients	Type 88 Ko	Type 4, Mk 5, K5	Type 1, Mk 1, P1	Type 1, Mk 6, P6
Ammonium nitrate	—	75	—	—
Ammonium perchlorate	75	55	—	—
Ammonium picrate	—	—	81	86
Aluminium	—	—	16	—
Ferro-silicon	16	10	—	11
Wood meal	6	5	2	2
Lubricating oil	3	1	1	1
Density	1.05	1.05	1.16	1.13
Rate of detonation (m/sec)	3800	—	4280	4620

In addition to aluminium, calcium silicide or ferro-silicon, the use of silicon was also recommended. The comparative figures illustrating the effect of the addition of these compounds on the strength of the explosive have been given by Sartorius [70] (Table 59). The power is expressed in terms of expansion in the lead block (taking picric acid as 100).

TABLE 59
INFLUENCE OF THE INGREDIENTS ON THE EXPLOSIVE POWER OF MIXTURES

Ingredients	Single explosive	Mixtures with addition of		
		10% of silicon	10% of ferro-silicon	10% of calcium silicide
PTN	146	152	148	146
Cyclonite	135	143	141	140
Picric acid	100	108	102	106
TNT	94	93	94.5	96

It was also observed that the increase in lead block expansion caused by the addition of silicon is a half or two thirds smaller than that caused by the addition of aluminium.

Zinc appeared to be too reactive and has not found any practical application.

The preparation of S-type mixtures. The following description of the preparation of S-16 mixture is provided as an example. In a stainless steel kettle of 500 kg capacity equipped with a stirrer and steam-heated to 118°C, 250 kg of the mixture is prepared by pouring in the ingredients, in the following sequence:

50 kg of ethylenediamine dinitrate
30 kg of sodium nitrate
10 kg of potassium nitrate
160 kg of ammonium nitrate

The ingredients are added slowly, in batches, so that the mixture heats up before the next batch is added. It is necessary to prevent the temperature from dropping below 90°C otherwise melting is prolonged.

After all the ingredients have been introduced into the kettle the temperature rises to 113–115°C. At this temperature the mixture forms a clear melt in 20 min. If the mixture remains turbid, further heating and stirring is necessary.

When melting is complete the mixture is allowed to stand without stirring for 5 min, after which the contents are emptied through the bottom valve into another kettle situated below. 200 kg of aluminium powder and 50 kg of cyclonite are added. The temperature falls but must not be allowed to drop below 100°C. The contents of the kettle are then heated to 113°C while stirring for 10 min.

After stirring the mass is cast straight into the shells or onto trays where it solidifies, forming a layer 2 cm thick. The mass is then broken into pieces which are

loaded into the shells and the spaces between filled either with fresh material or TNT or an alloy of TNT with cyclonite.

Since the mixture is highly hygroscopic it should be protected against atmospheric moisture. During melting it is also necessary to avoid contact between the mixture and brass or other copper alloys since the latter are liable to react with metallic aluminium. Kettles should be washed with water every 24 hr to remove all residues of the mixture.

MIXTURES WITH CHLORATES AND PERCHLORATES

Mixtures with potassium and sodium chlorates

As early as 1818 Berthollet [71] suggested the replacement of potassium nitrate in blackpowder by potassium chlorate, which he had prepared for the first time in 1786. Thus, "white powder", which is a mixture of potassium chlorate with sugar, was evolved. However, this mixture proved to be particularly sensitive to friction and impact, hence its preparation and use was extremely dangerous. Further experiments showed that pure potassium chlorate has no explosive properties but when used in admixture with combustibles such as sugar, starch or aluminium it gives rise to an explosive highly sensitive to mechanical action, especially to friction. A disastrous explosion occurred in the potassium chlorate factory at St. Helens, near Liverpool, in 1899. The storehouse in which barrels containing 150 tons of potassium chlorate were kept was enveloped in flames. At first the contents of the storehouse burned, but after a time an explosion took place. In all probability, the explosion was caused by the fact that some of the potassium chlorate was melted in the fire and the molten salt, together with the wood of the barrels, formed a mixture which exploded under the influence of high temperature.

The manufacture and use of some mixtures containing potassium and sodium chlorate were forbidden in several countries on account of their high sensitiveness to friction. In Great Britain, for instance, the production of a mixture of potassium chlorate and sulphur was prohibited by law in 1894. Mixtures of potassium chlorate with phosphorus should also be avoided owing to the great dangers involved with their preparation and handling. This is why the heads of safety matches are made from mixtures of potassium chlorate with sulphur and with manganese dioxide and potassium dichromate bound with glue.

The addition to potassium chlorate of vegetable oils, fats or mineral oils in which aromatic nitro compounds are dissolved, as recommended by Street [72], proved to be a milestone in the development of chlorate explosives. The application of an admixture of castor oil was particularly useful. The presence of oils and fats in the explosives reduced their sensitiveness to friction and impact, and the oily ingredient conferred a slightly plastic consistency.

The effect of adding various organic substances to potassium chlorate on the detonating capacity of the resultant mixtures, and on their power was studied system

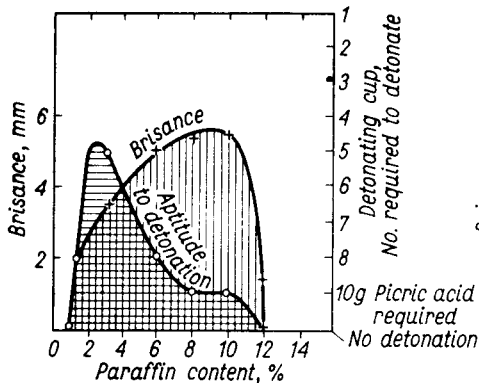

FIG. 72. Explosive properties of the mixtures of potassium chlorate with kerosene (according to Chemisch-Technische Reichsanstalt [73]).

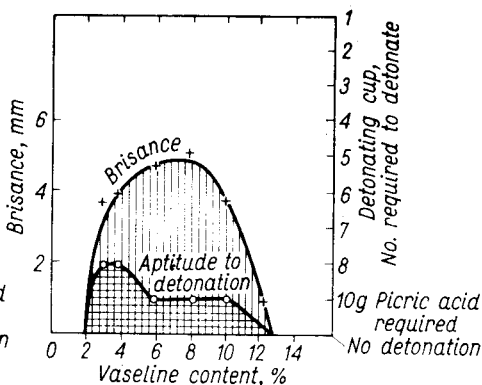

FIG. 73. Explosive properties of the mixtures of potassium chlorate with vaseline (according to Chemisch-Technische Reichsanstalt [73]).

atically at the Chemisch-Technische Reichsanstalt [73]. The results that refer to mixtures of potassium chlorate with kerosene, vaseline and nitrobenzene are shown in Figs. 72, 73 and 74.

As was to be expected, mixtures with nitrobenzene are the most powerful and the most readily detonated. Mixtures with kerosene or vaseline are of equal strength,

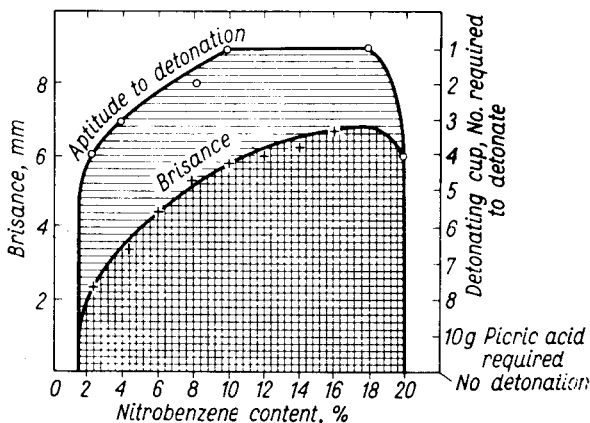

FIG. 74. Explosive properties of the mixtures of potassium chlorate with nitrobenzene (according to Chemisch-Technische Reichsanstalt [74]).

those with a small kerosene content (e.g. 2–4%) detonate more easily than those containing the same amount of vaseline while the mixtures which contain a larger amount of kerosene or vaseline (e.g. 8–10%) detonate with more or less equal ease.

The graphs for mixtures with paraffin oil lie close to those with kerosene while mixtures with paraffin (m.p. 52°C) are similar to those with vaseline.

Other studies of the effect of the structure of phlegmatizing substances on the sensitiveness to impact of potassium chlorate mixtures were carried out by Blinov [74]. He investigated mixtures consisting of 92% potassium chlorate and 8% liquid phlegmatizing compound or of 85% potassium chlorate and 15% solid phlegmatizing compound. As far as phlegmatizing liquids are concerned it turned out that the impact sensitiveness of the resultant mixtures is independent of the viscosity of the liquid. Blinov proved that the phlegmatizing effect of such compounds increases in proportion to the shortness of the carbon chain. This can be seen from the examples given in Table 60. Moreover, increase in the plasticity of a solid substance brings about a decrease in its sensitiveness; this is shown by comparing the phlegmatizing effects of vaseline and paraffin.

TABLE 60
THE PHEGMATIZING EFFECT OF VARIOUS COMPOUNDS

Phlegmatizing compound	Sensitiveness to impact, cm
Butyric acid	50
Valeric acid	45
Stearic acid	20
Oleic acid	12
Vaseline	55
Paraffin	26

Potassium chlorate can be replaced by sodium chlorate which is cheaper and more widely available although being somewhat hygroscopic it is much less frequently used as a constituent of explosives.

Chlorate explosive mixtures have the disadvantage that they cake and set solid during storage. Some ingredients such as vaseline or paraffin tend to aggravate this trouble. To counteract this tendency ingredients are added which have a loosening effect on the explosive composition, giving a relatively low density (e.g. wood meal or cork dust). In the U.S.S.R. extensive work on this subject was carried out by Shpitalskii and Krause [75].

The most effective method of preventing caking in chlorate explosives is to manufacture them in granular form. For this purpose various resins (e.g. colophony) or waxes (e.g. Carnauba) are added to the mixture. The moist mass is then rubbed through a sieve and dried. The grains so formed are sifted through screens to separate out the dust.

Explosives of this type were manufactured at Chedde in France, whence they derived their name of Cheddite. They were recommended originally for use in mines, but were gradually withdrawn as unsafe to use in the presence of methane and coal-dust.

For military purposes Cheddites were usually produced with the following composition given in Table 61.

TABLE 61
THE COMPOSITION OF CHEDDITES

Constituents	Name				
	Explosif O No. 1 Type 41	Explosif O No. 1 Type 60 bis	Explosif O No. 2 modifié	Type O No. 6B	Explosif S
Potassium chlorate	80	80	79	90	—
Sodium chlorate	—	—	—	—	90
Dinitrotoluene	—	2	15	—	—
Nitronaphthalene	12	13	1	—	—
Castor oil	8	5	5	—	—
Vaseline	—	—	—	3	3
Paraffin	—	—	—	7	7

The first three types of Cheddites were used in France for filling hand grenades and shells with a low muzzle velocity and for manufacturing demolition charges during World War I. When there was a shortage of nitro compounds in France, Cheddite type O No. 6B was employed as a substitute for the first two. This was also manufactured with sodium chlorate instead of potassium chlorate (Explosif S).

Kast [3] gives the following figures as characteristic of Cheddite type O No. 2, modifié:

Apparent density	1.15
Heat of explosion	1185 kcal/kg
Gas volume (V_0)	337 l./kg
Temperature of explosion	ca. 4500°C
Specific pressure (f)	6090 m
Rate of detonation (at a density of 1.3)	3000 m/sec
(at a density of 1.5)	4000 m/sec
Lead block expansion	255 cm ³
Sensitiveness to impact (2 kg)	30 cm

The rate of detonation of Cheddite type O No. 6B appears to differ slightly from that of the above composition although it contains no TNT; at a density of 1.4 it is 3500 m/sec.

The chlorate explosives can be easily compressed to a density of 1.9 although at such a high density they are more difficult to detonate (see also Fig. 75, p. 279).

Chlorate explosives yield only a small amount of gaseous products since the major product of explosion is potassium chloride. The specific pressure f is therefore relatively low (the high temperatures do not compensate for the small volume of gases), hence the lead block expansion is low, but Cheddites without nitro compounds—type O No. 6 and S—give an even smaller lead block expansion: 180–200 cm³. Some chlorate explosives, when detonated in the open, do not transmit detonation from cartridge to cartridge, differing in this respect from dynamites and ammonium nitrate explosives. In a confined space, however, they behave differently. Here the

transmission of detonation over a distance is superior to that of ammonium nitrate explosives. T. Urbański [76] has reported that cartridges of Miedziankit (100 g, 30 mm dia.) can transmit detonation in the bore hole of the mortar of an experimental gallery for a distance of over 40 cm.

The main disadvantages of chlorate explosives such as sensitiveness to friction and impact and caking in storage, were overcome by Sprengel [77], who introduced the technique of mixing the ingredients immediately before use. To facilitate mixing, the combustible component of the explosive had a liquid consistency. This led to the development of the explosive "Rack-à-rock", consisting of potassium chlorate and nitrobenzene. It played an important part in many engineering achievements at the turn of the nineteenth century especially, in Russia and in the U.S.A.

A considerable advance was made by Łaszczynski [78], when he worked out the composition and method of preparation of the explosive Miedziankit consisting of:

90% of potassium chlorate
10% of kerosene

Cartridges containing only potassium chlorate were transported in safety to the site, where they were dipped for a definite time into kerosene just before use. Miedziankit was also manufactured by soaking potassium chlorate cartridges with kerosene in the explosive factory. Kerosene with an ignition temperature above 30°C was employed, to render the product safe for rail transport. According to T. Urbański [76] the rate of detonation of Miedziankit is 3000 m/sec in an iron pipe at a density of 1.7.

Miedziankit was one of the most widely used non-military explosives in Germany, Russia and Poland before, during and immediately after World War I, when there was a need to economize in the nitrates, including ammonium nitrate, used for military purposes.

It is a feature of chlorate explosives that ammonium salts (e.g. ammonium nitrate) must not be added to chlorate compositions (Vol. II).

The converse obviously applies to ammonium nitrate explosives, which must not contain any chlorates, since during storage a double exchange reaction may occur resulting in the formation of ammonium chlorate (p. 476, Vol. II), an unstable substance which decomposes spontaneously. A number of patents were taken out between 1880 and 1895, for explosives based on the use of ammonium chlorate or mixtures of ammonium nitrate with potassium or sodium chlorate. Many accidents which occurred through the spontaneous decomposition of these explosives proved the impossibility of using mixtures containing both chlorates and ammonium salts (Hantke [79]).

MIXTURES WITH POTASSIUM AND AMMONIUM PERCHLORATES

Potassium perchlorate in the pure state, like potassium chlorate, is not an explosive, indeed the decomposition of the former is endothermic:

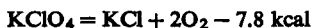

When mixed with non-explosive combustibles, potassium perchlorate produces compositions relatively difficult to detonate; e.g. the mixture of potassium perchlorate with paraffin in a ratio of 85 : 15 gives a lead block expansion of only 60 cm³, whereas a similar mixture with potassium chlorate gives approximately 200 cm³. On the other hand, the higher content of oxygen in potassium perchlorate and the

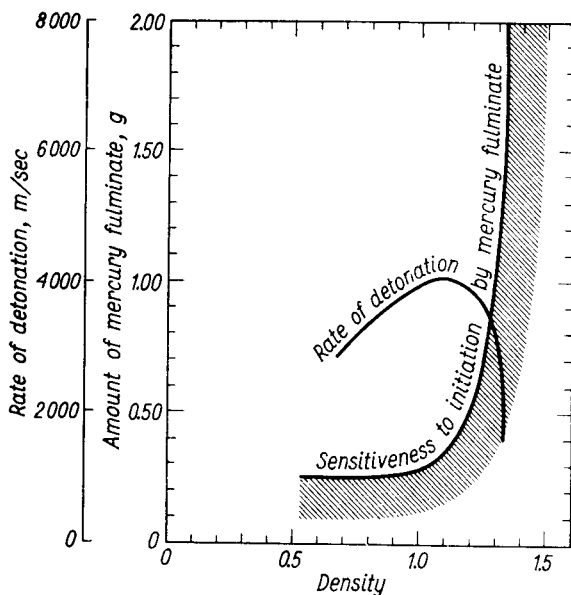

FIG. 75. The relation between the density and the rate of detonation, and sensitiveness to initiation by mercury fulminate of chlorate explosive [80].

smaller amount of potassium chloride produced during decomposition makes it possible to form mixtures which are 10–15% stronger than chlorate mixtures. The sensitiveness of perchlorate mixtures to friction and impact is lower than that of chlorate mixtures, and their ignition temperature is higher.

In spite of their advantages, mixtures with potassium perchlorate as the chief constituent are not very often used since the latter is too expensive. Other disadvantages of such mixtures lie in their rather high sensitiveness to mechanical impulses, the relatively great difficulty of detonating them, and their fairly high ability for deflagration. Potassium perchlorate is therefore often employed simply as an additive to ammonium nitrate explosives (p. 264).

Another constituent of perchlorate explosives, ammonium perchlorate, unlike ammonium chlorate, is stable. It is also dissimilar to potassium perchlorate in being an explosive in the pure state, like ammonium nitrate. The greater specific gravity of ammonium perchlorate gives to explosives with which it is mixed a greater power than that of similar ammonium nitrate explosives. The former are also more sensitive than chlorate explosives to friction and impact and to thermal ignition.

On explosive decomposition they may produce a certain amount of hydrogen chloride which is highly undesirable in mining explosives.

Perchlorate explosives, like chlorate explosives, can be compressed to a high density, but the detonation at a high density is difficult. This is illustrated by a graph published by the French Commission on Explosives (Commission des Substances Explosives) (Fig. 75) [80] which shows how the rate of detonation and the amount of mercury fulminate required for detonation varies with density.

As early as 1865 Nisser [81] recommended the use of potassium perchlorate instead of potassium chlorate. Ammonium perchlorate as a constituent of explosives was proposed by Nobel [82] in 1888, and explosives with ammonium perchlorate as a chief component were proposed by Alvisi [83] in 1895 and Carlson [84] in 1897. Explosives containing ammonium perchlorate are used in Japan in the mining industry (p. 474). Yonckites, developed by Yonck [85] (p. 447) were extensively used in the Belgian mining industry. Cheddites with ammonium perchlorate instead of potassium chlorate were manufactured in France.

Perchlorate Cheddites were employed in France and Italy for filling shells with a low muzzle velocity during World War I (trench mortar shells, aerial bombs etc.). Originally these were the explosives which imitated Cheddites containing DNT (types B and C). Later, chiefly owing to a shortage of nitro compounds, paraffin was utilized as a combustible ingredient. Thus emerged the explosives 86/14, 90/10 and E (Table 62).

TABLE 62
COMPOSITION OF CHEDDITES

Constituents	Type B	Type C	Type P	Ch or 86/14	90/10	E
Ammonium perchlorate	82	50	61.5	86	90	92
Sodium nitrate	—	30	30	—	—	—
DNT	13	15	—	—	—	—
Castor oil	5	5	—	—	—	—
Paraffin	—	—	8.5	14	10	8

Perchlorate explosives for mining, and technical methods of manufacturing chlorate explosives, will be discussed later (pp. 520–521). Mixtures of potassium perchlorate or ammonium perchlorate with plastics or elastomers have recently come into extensive use for jet propulsion (e.g. methyl polymethacrylate, ester resins, and thiokol-rubber).

In this connexion a number of investigations have been undertaken to examine the physico-chemical and explosive properties of these mixtures.

Gordon and Campbell [86], for instance, examined the exothermic decomposition of potassium perchlorate mixtures with carbon within the temperature range 300–360°C, while Grodzinski [87] studied the thermal decomposition of mixtures of various combustibles with potassium perchlorate.

PLASTIC EXPLOSIVES

Plastic explosives, such as dynamites, are explosives rich in a liquid constituent, e.g. nitroglycerine, usually with dissolved high viscosity polymers. Guhr dynamite (no more in use) composed of 75% nitroglycerine and 25% kieselguhr, the first explosive to have a plastic consistency, owed this property to the high proportion of liquid it contained.

Blasting gelatine is a plastic explosive consisting of 92–94% nitroglycerine and 6–8% collodion cotton (of high viscosity). Blasting gelatine is markedly elastic. It loses its elasticity, becoming plastic, only on heating to a temperature of 40°C or higher, depending on the type and amount of collodion cotton present. Recently a new kind of dynamite was developed in the U.S.S.R. Its plasticity was achieved by dissolving methyl polymethacrylate in nitroglycerine, in the proportions of twenty to forty parts of nitroglycerine to one part of the polymer.

Blasting gelatine and dynamites are now used only for civil purposes. Originally, they were suggested as military explosives, particularly for filling shells with a low muzzle velocity, until it was shown that fillings made with nitroglycerine explosives may cause premature explosions inside the barrel.

The Russian air force used bombs filled with a material resembling blasting gelatine during World War I.

Dynamites were retained for military purposes for some time for use in demolition charges. The disadvantage of these explosives lies in their limited chemical stability. Ultimately, therefore they were replaced by explosives that remain unchanged during storage (aromatic nitro compounds such as TNT, picric acid, and more recently TNT with cyclonite or PETN).

The plasticity in an explosive can be put to practical use, e.g. for demolition purposes. Thus, to sever an iron bar or to blow up a wall or a rock the easiest way is to use a plastic explosive, moulded to fit the shape of the object to be destroyed. Since blasting gelatine is not entirely safe to handle, being elastic, i.e. difficult to shape as required, attention was directed to the development of plastic materials based on other constituents. Thus, mixtures comprising a solution of collodion cotton in liquid aromatic compounds as plasticizers were suggested. Such were Plastrotyl, recommended by Bichel [88] with a composition:

86% of TNT
10% of liquid DNT (m.p. 20–25°C)
0.3% of collodion cotton
3.7% of turpentine

and the Swedish perchlorate plastic explosive Territ suggested by Nauckhoff [89]:

43% of ammonium perchlorate
28% of sodium nitrate
27.8% of TNT and DNT
1.2% of collodion cotton

According to Kast [3] the explosive properties of Territ are:

Density 1.67 (max. 2.15)
 Rate of detonation 4700 m/sec
 Lead block expansion 340 cm³
 Sensitiveness to impact (2 kg) 20 cm

Plastrotyl and Territ were rather difficult to detonate chiefly due to their great density. To make these mixtures detonate more readily, nitroglycerine was added but this increased their sensitiveness to impact.

In 1929, Stettbacher [90] suggested the use of a mixture of PETN with nitroglycerine, under the name of Penthrinite. Such a mixture may be plastic provided suitable amounts of nitroglycerine and PETN with crystals of a proper size are used and both constituents are thoroughly mixed. Stettbacher recommended a composition ranging with the limits:

10-70% of PETN
 90-30% of nitroglycerine

If a mixture rich in nitroglycerine is employed it may be converted into a plastic one by the addition of collodion cotton.

In his later work Stettbacher developed the idea of using penthrinites as substitutes for dynamite, with the following composition:

50% of PETN
 46% of nitroglycerine
 4% of collodion cotton

Stettbacher's proposals were subjected to sharp criticism by Naoúm [91] who considered the substitution of such mixtures for dynamite to be inexpedient, since:

- (a) they are considerably more expensive than nitroglycerine and,
- (b) they cannot replace dynamite as mining explosives.

The Chemisch-Technische Reichsanstalt [73] examined the properties of PETN mixtures with nitroglycerine and found that the latter easily exudes from mixtures in which more than 20% is present, especially at an elevated temperature, e.g. 50°C. However, Stettbacher's observation that penthrinite can be compressed to high density more easily than PETN itself was confirmed. Hand tamping of PETN gives a density of 0.9, whereas a mixture of 80% PETN with 20% nitroglycerine gives 1.3. The following densities of these mixtures were obtained under higher pressures:

Pressure, kg/cm ²	Density
250	1.60
1000	1.62
2000	1.66
3000	1.67

The rate of detonation of a mixture compressed to a density of 1.67 is 7600 m/sec whereas PETN of equal density detonates with a rate of 8400 m/sec.

Plastic explosives with cyclonite as the chief constituent were used extensively during World War II. Cyclonite is preferable as it detonates easily even when strongly phlegmatized (desensitized to impact) and as its rate of detonation is very high.

Originally a mixture of 88% cyclonite with 12% lubricating oil was employed. This mass however was not sufficiently plastic and lost its plasticity readily by exuding the oil at a high temperature. It was therefore replaced by a mixture named Composition C-3 of 77% cyclonite and 23% gel made out of liquid nitro compounds (e.g. liquid DNT) and nitrocellulose or of butyl phthalate and nitrocellulose.

The composition C-3 was later improved and designated Composition C-4. It contains:

91.0% of cyclonite
2.1% of polyisobutylene
1.6% of motor oil
5.3% of di-(2-ethylhexyl)sebacate

It is less volatile than C-3 and has less tendency to harden at low temperature. It has a density of 1.59, does not become hard even at -55°C (-70°F), and does not exude at $+77^{\circ}\text{C}$ (170°F).

For some types of explosive working of metals, plastic sheet explosives EL-506 were developed by E. I. du Pont de Nemours and Co., Inc.

One of the representatives of this group of explosives, EL-506 A, consists of PETN combined with plasticizers to form flexible sheets of 10×20 in., fabricated in a number of thicknesses [68].

The German plastic material Hexoplast 75 was composed of:

75% of cyclonite
3.6–3.8% of TNT
20% of DNT (liquid)
1.2–1.4% of nitrocellulose

The freezing point of a TNT and DNT mixture was -20°C . The ingredients were mixed in a Werner-Pfleiderer kneader at 90°C , the cyclonite with the nitrocellulose being added first and nitro compounds added after thorough mixing. This prevented the formation of lumps of swollen nitrocellulose.

INCOMPATIBILITY IN EXPLOSIVE MIXTURES

It is well known that some ingredients of explosive mixtures should not be brought together, as their mutual reaction produces undesirable changes of the properties of the explosive mixture.

Although a considerable amount of work was done on the compatibility of various components of explosive mixtures no systematic study of this particular problem was made until in 1938 T. Urbański [6] began a series of investigations which comprised examination of mixtures:

(1) By thermal analysis [38, 40].

(2) By determining their chemical stability and ignition temperature, e.g. the stability of nitroglycerine- or PETN-, or nitrocellulose-nitro compound mixtures (Vol. II, pp. 49, 181 and Vol. III, p. 566, respectively) [7].

The influence of various non-explosive substances, such as sulphur, was also examined. It was found that the latter considerably reduces the temperature of

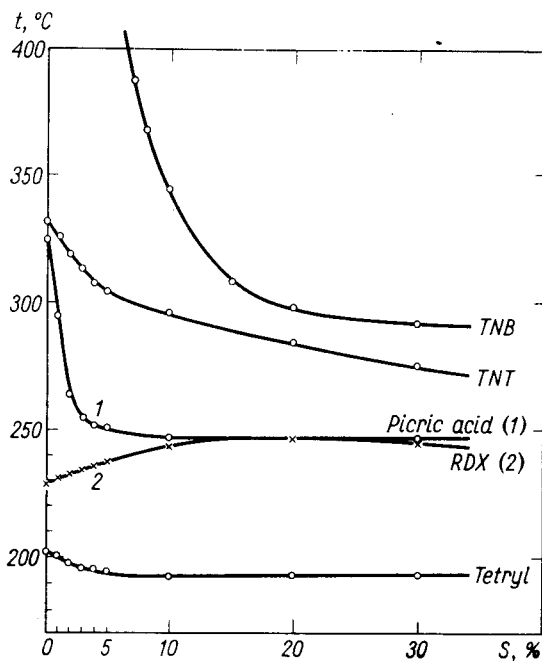

FIG. 76. The influence of sulphur on ignition temperature of nitro compounds and cyclonite (according to T. Urbański and Pillich [92]).

ignition of TNT and other high-nitrated aromatic compounds (Vol. I, p. 305)—Fig. 76 [92].

(3) By determining the sensitiveness of mixtures to impact and friction. Foreign crystals were found to increase the sensitiveness of nitro compounds when present in relatively small quantities (e.g. a few percent) [5, 92] — Figs. 66, 68 and 70 (pp. 250, 251 and 262, respectively). On the contrary an addition of soft crystals of wax-like substances is well known to desensitize explosives.

(4) By determining the explosive properties in mixtures [6]; this is discussed on pp. 250–252.

The problem of incompatibility is discussed in various places in this book (e.g. incompatibility of chlorates with ammonium salts, p. 476, Vol. II and p. 278, Vol. III).

The action on TNT of various substances, which may occur in the explosive (e.g. ferric oxide) is described on pp. 304–305, Vol. I.

The action of some inorganic substances on unsymmetrical isomers of trinitrotoluene is mentioned on p. 331, Vol. I.

Another important practical problem is the action of tetranitromethane on TNT (p. 339, Vol. I).

One of the important problems of compatibility in explosive mixtures is whether ammonium nitrate can react with nitro compounds, such as TNT. This was discussed by Lang and Boileau [64]. These authors concluded that no reaction can occur between TNT and ammonium nitrate when they are pure. The evolution of ammonia from ammonium nitrate on storage at room temperature does not suffice to produce any reaction with TNT.

However any alkaline reaction which can be developed by some impurities may produce an evolution of ammonia sufficient to form dark-coloured, readily ignitable products.

Recently Rogers [93] pointed out that two types of incompatibility should be distinguished, otherwise confusion may result. Incompatibility of the first type may be caused by secondary chemical reactions or mobility of residual solvents, gases, or plasticizers, leading to unexpected modifications of mechanical, physical, or electrical properties.

Incompatibility of the second type appears as an unexpected increase in sensitiveness or decrease in thermal stability, and may be caused by any of the foregoing phenomena. Rogers found that zinc reacts readily with ammonium nitrate. He also found that adding 20% urea to RDX reduces the thermal stability of the latter.

LITERATURE

1. Chemische Fabrik Griesheim, Ger. Pat. 69897 (1892).
2. H. MAXIM, U.S. Pat. 792716 (1905).
3. H. KAST, *Spreng- u. Zündstoffe*, Vieweg & Sohn, Braunschweig, 1921.
4. YA. I. LEITMAN, according to A. G. GORST, *Porokha i vzryvchatyye veshchestva*, Oborongiz, Moskva, 1949.
5. T. URBAŃSKI, *Przemysł chem.* **20**, 117, 179 (1936); *Z. ges. Schiess- u. Sprengstoffw.* **33**, 41, 62 (1938).
6. T. URBAŃSKI, *Przemysł chem.* **22**, 521 (1938); *Mém. artill. franç.* **20**, 237 (1946).
7. T. URBAŃSKI, B. KWIATKOWSKI and W. MIŁADOWSKI, *Przemysł chem.* **19**, 225 (1935); *Z. ges. Schiess- u. Sprengstoffw.* **32**, 1, 57, 85 (1937).
8. T. URBAŃSKI, *Roczniki Chem.* **17**, 588 (1937).
9. P. LAFFITTE and A. PARISOT, *Compt. rend.* **203**, 1516 (1936).
10. W. O. WILLIAMSON, *Research* **11**, 387 (1958).
11. A. W. KOCH and H. FREIWALD, *Explosivstoffe* **6**, 279 (1958).
12. L. ANDRUSSOW, *Explosivstoffe* **7**, 89 (1959).
13. A. W. KOCH and H. FREIWALD, *Explosivstoffe* **9**, 221, 247 (1961).
14. C. GIRARD, Fr. Pat. 350371 (1904).
15. Dynamit A.G., Ger. Pat. 568000 (1932); Brit. Pat. 742312 (1932).
16. N. C. BOYD, Hercules Powder Co., U.S. Pat. 1840431, 1877520 (1932).

17. C. MANUELI and BERNARDINI, Brit. Pat. 138371 (1920).
18. T. URBAŃSKI and J. SKRZYŃECKI, *Roczniki Chem.* **16**, 353 (1936).
19. A. LE ROUX, *Mém. poudres* **35**, 121 (1953).
20. L. MÉDARD, *Mém. poudres* **36**, 87 (1954).
21. R. KREMANN, *Monatsh.* **25**, 1215, 1271 (1904); **26**, 143 (1905); **27**, 627 (1906).
22. R. KREMANN *et al.*, *Monatsh.* **27**, 125 (1906); **29**, 863 (1908); **32**, 609 (1911); **37**, 723 (1916); **38**, 385 (1917); **39**, 505 (1918); **40**, 189 (1919); **41**, 499 (1920); **42**, 167, 181, 199 (1921); **44**, 163 (1923).
23. M. GIUA, *Ber.* **47**, 1718 (1914); *Gazz. chim. ital.* **45**, I, 339, 557; II, 32, 348 (1915); **46**, II, 272 (1916); **47**, I, 57 (1917); *Lezioni di Esplosivi*, Torino, 1932.
24. P. PASCAL, *Bull. soc. chim. France* [4], **27**, 388 (1920).
25. D. H. ANDREWS, *J. Phys. Chem.* **29**, 1041 (1925).
26. O. WYLER, *Helv. Chim. Acta* **15**, 23 (1932).
27. N. N. YEFREMOV and A. M. TIKHOMIROVA, *Izv. Inst. Fiz.-Khim. Analiza* **3**, 269 (1926); **4**, 65, 92 (1928).
28. N. N. YEFREMOV and O. K. KHAIBASHEV, *Izv. Sektora Fiz.-Khim. Analiza Akad. Nauk* **17**, 130 (1949).
29. A. WOGRINZ and P. VÁRI, *Z. ges. Schiess- u. Sprengstoffw.* **14**, 249 (1919).
30. C. A. TAYLOR and W. H. RINKENBACH, *Ind. Eng. Chem.* **15**, 73, 795, 1070 (1923).
31. JOVINET, *Mém. poudres* **23**, 36 (1928).
32. K. HRYNAKOWSKI and Z. KAPUŚCIŃSKI, *Roczniki Chem.* **14**, 115 (1934).
33. T. URBAŃSKI and B. KWIATKOWSKI, *Roczniki Chem.* **14**, 941 (1934).
34. V. TAMBURRINI, *Ann. chim. appl.* **17**, 275 (1927).
35. M. KURITA and J. HAGUI, *J. Chem. Soc. Japan* **50**, 155 (1929).
36. L. MÉDARD, *Mém. poudres* **24**, 174 (1930–1931).
37. J. HACKEL, *Roczniki Chem.* **16**, 266, 323 (1936).
38. T. URBAŃSKI, *Roczniki Chem.* **13**, 399 (1933); **14**, 925 (1934); **15**, 191 (1935).
39. G. DESSEIGNE, *Mém. poudres* **30**, 127 (1948).
40. T. URBAŃSKI and I. RABEK-GAWROŃSKA, *Roczniki Chem.* **14**, 239 (1934).
41. O. K. KHAIBASHEV and O. F. BOGUSH, *Nauchno-issl. raboty Khim. Inst. Akad. Nauk 1941–1943*, 78 (1945).
42. T. URBAŃSKI and S. KOŁODZIEJCZYK, *Roczniki Chem.* **16**, 119 (1936).
43. BOMBIRINI-PARODI DELFINO, Ger. Pat. 651780 (1937).
44. M. J. URIZAR, E. D. LOUGHRAN and L. C. SMITH, *Explosivstoffe* **10**, 55 (1962).
45. I. M. CHELTSOV, according to A. G. GORST, *Porokha i vzryvchatyye veshchestva*, Oborongiz, Moskva, 1949.
46. C. J. OHLSSON and J. H. NORRBIN, Swedish Pat. of 31 May 1867.
47. A. PARISOT, Thèses, Nancy, 1939.
48. T. URBAŃSKI, J. HACKEL and B. KWIATKOWSKI, *Przegląd Techniczny* (1938).
49. J. HACKEL, *Wiad. Techn. Uzbr.* **38**, 519 (1937).
50. W. M. EVANS, *Proc. Roy. Soc. (London)* **204** A, 14 (1950).
51. J. L. COPP and A. R. UBBELOHDE, *Trans. Faraday Soc.* **44**, 464 (1948).
52. J. HACKEL, unpublished work (1946).
53. MACAR, Belgian Pat. 142506 (1899).
54. DEISSLER, Belgian Pat. (1897).
55. GOLDSCHMIDT, *J. Soc. Chem. Ind. (London)* 543 (1898).
56. R. ESCALES, Brit. Pat. 24377 (1899); Belgian Pat. 145599 (1899).
57. VON DAHMEN, according to [63].
58. G. ROTH, Ger. Pat. 172327 (1900).
59. H. KAST, *Jahresber. Mil. Vers. Amt.* **8**, 48 (1902); **9**, 18 (1903); **10**, 4 (1905); **13**, 17 (1908).
60. H. MURAOUR, *Protar (Solothurn)* **9**, 62 (1943).

61. According to A. STETTACHER, *Protar (Solothurn)* **9**, 212, 233 (1943).
62. E. CHAYLAN, *Mém. poudres* **30**, 139 (1948).
63. B. T. FEDOROFF *et al.*, *Encyclopedia of Explosives and Related Items*, Vol. I, Picatinny Arsenal, Dover, U.S.A., 1960.
64. F. M. LANG and J. BOILEAU, *Mém. poudres* **34**, 181 (1952).
65. P. AUBERTEIN, Fr. Pat. 1180530 (1957-1959).
66. R. FÖRG, *Ammonal*, Otto Klemm, Wien-Leipzig, 1917.
67. H. KOENEN and P. DITTMAR, *Explosivstoffe* **11**, 54 (1963).
68. According to J. S. RINEHART and J. PEARSON, *Explosive Working of Metals*, Pergamon Press, Oxford, 1963.
69. The Dow Chemical Company, *Dow MS-80*, Midland, Michigan.
70. R. SARTORIUS, *Mém. poudres* **34**, 205 (1952).
71. C. BERTHOLLET, *Ann. chim.* **9**, 22 (1818).
72. STREET, Ger. Pat. 100522, 100523 (1897); 117051, 118102 (1898); Brit. Pat. 9970, 13724 (1897); 12760, 12761, 24468 (1898); Fr. Pat. 267407 (1897).
73. *Jahresber. Chem.-Techn. Reichsanstalt* **8**, 115 (1929).
74. I. F. BLINOV, *Zh. prikl. khim.* **8**, 52 (1935).
75. E. SHPITALSKII and E. KRAUSE, *Z. ges. Schiess- u. Sprengstoffw.* **20**, 103 (1925).
76. T. URBAŃSKI, *O/Schlesischer Berg- u. Hüttenmänn. Vereins Z.* **65**, 217 (1926).
77. SPRENGEL, Brit. Pat. 921, 2424, 2642 (1871); *J. Chem. Soc.* **26**, 796 (1873).
78. ŁASZCZYŃSKI, Ger. Pat. 215202 (1909); 237225 (1910).
79. HANTKE, *Angew. Chem.* **50**, 473 (1937).
80. H. DAUTRICHE, *Mém. poudres* **14**, 206 (1906-1907).
81. NISSER, Brit. Pat. 1934 (1865); 1375 (1868).
82. A. NOBEL, Brit. Pat. 1471 (1880).
83. U. ALVISI, Brit. Pat. 9190, 25838 (1898); *Gazz. chim. ital.* **29**, I, 121, 399; II, 64, 478 (1899); **31**, I, 221 (1901).
84. O. F. CARLSON, Brit. Pat. 10362 (1897); Swedish Pat. 8487 (1897).
85. YONCK, Belgian Pat. 143499, 143656 (1899); Brit. Pat. 24511 (1903).
86. S. GORDON and C. CAMPBELL, *Vth Symposium on Combustion*, p. 277, Reinhold, New York, 1955.
87. J. GRODZINSKI, *J. Appl. Chem.* **8**, 523 (1958).
88. C. E. BICHEL, Ger. Pat. 193213 (1906).
89. S. NAUCKHOFF, Swedish Pat. 30408 (1909).
90. A. STETTACHER, *Z. ges. Schiess- u. Sprengstoffw.* **24**, 229 (1929).
91. PH. NAOUM, *Z. ges. Schiess- u. Sprengstoffw.* **25**, 376, 442 (1930).
92. T. URBAŃSKI and J. PILLICH, *Wiad. Techn. Uzbr.* **43**, 79 (1939).
93. R. N. ROGERS, *Ind. Eng. Chem., Products Res. and Dev.* **1**, 169 (1962).

CHAPTER II

LIQUID EXPLOSIVES

HISTORICAL

THE use of explosives obtained from two non-explosive constituents, at least one of which is in the liquid phase, was suggested by Sprengel [1] in 1871. The constituents were mixed just before the explosive was used to avoid the dangers of transport and handling. Nitric acid was one of the liquid constituents, together with liquid or solid aromatic nitro compounds. Such explosives were not, however, successful apart from the Sprengel mixtures in which the oxidizing agent, e. g. potassium chlorate, is a solid constituent; these substances are reviewed on p. 278.

The explosives proposed by Turpin [2], under the name of Panclastites, in which nitrogen dioxide was the oxidizing agent, were more successful.

After the liquefaction of air had been achieved by Olszewski and Wróblewski [3] and on a large scale by Linde [4] the use of liquid oxygen as an oxidizing agent became possible in composite explosives called Oxyliquits (Linde [5]).

Liquid explosives came into extensive use during World War I when nitro compounds and ammonium nitrate became scarce: panclastites were most commonly used for military purposes and oxyliquits in the mining industry. During the World War II the Germans employed liquid mixtures for jet propulsion including a new-comer in this field—a mixture of concentrated (80–85%) hydrogen peroxide with hydrazine for the propulsion of V2 rockets.

MIXTURES WITH NITROGEN DIOXIDE, NITRIC ACID AND TETRANITROMETHANE

Nitrogen dioxide was used in mixtures with such combustibles as paraffin (without aromatic compounds), carbon disulphide or nitrobenzene. These substances were used in the proportions necessary to give complete decomposition into CO_2 , H_2O and N_2 , thus permitting full utilization of the oxygen present in the nitrogen dioxide. To prevent the solidification of nitrobenzene at low temperatures a binary combustible constituent, e.g. a mixture of nitrobenzene with carbon disulphide, was used.

Kast and Günther [6] examined the explosive properties of these mixtures and found them to be similar to nitroglycerine. They also had its advantages (great power) and disadvantages (high sensitiveness to mechanical stimulants). They differ from nitroglycerine in their lower specific gravity, which obviously contributes to

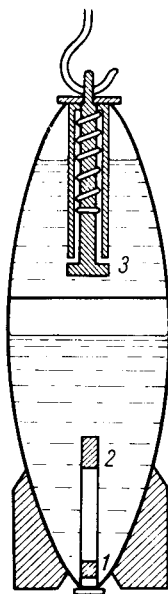

FIG. 77. Aerial bomb filled with liquid nitrogen dioxide (lower compartment) and combustible liquid, e.g. petrol (according to Pascal [7]).

a somewhat lower brisance. A mixture of nitrogen dioxide with 21% by weight of petrol (35% by volume) gives a rate of detonation of 7100 m/sec. A mixture with 35.5% by weight of nitrobenzene (40% by volume) detonates with a rate of 7650 m/sec.

During World War I the French used aerial bombs constructed in such a fashion that the two constituents of the explosive filling were mixed after the bomb had been released. The risk of handling and transporting such a dangerous explosive was thus avoided (Fig. 77). The shell of this bomb was divided into two compartments by a thin partition wall. The lower compartment, fitted with a percussion fuse (1) and detonator (2) was filled with liquid nitrogen dioxide. A spring hammer (3) held back by a hook was located in the upper compartment of the bomb which was filled with petrol immediately before the aircraft had started. On release of the bomb the hammer was unhooked and pierced the partition wall, and at the same time the bomb turned upside down so that the compartment fixed with vanes was uppermost and its contents—nitrogen dioxide (m.p. -10.2°C ; b.p. $+22^{\circ}\text{C}$; density at 0°C 1.4903)—the heavier constituent easily flowed down to mix with the other constituent, i.e. petrol.

The explosives recommended by Hellhoff [8] are also noteworthy. They consist of concentrated nitric acid and dinitrobenzene or a mixture of nitrobenzene with dinitrobenzene. They have not been used very extensively for practical purposes, because their nitric acid content makes them extremely corrosive, but under war-time conditions they were considered to be the cheapest explosives and the simplest to prepare. During World War II they were suggested in Great Britain under the name of Dithekite. According to Cook, Pack and Gay [9] Dithekite-13 or D-13 has the following composition:

24.4% of nitrobenzene
62.6% of nitric acid
13% of water

In liquid mixtures tetranitromethane may be used as an oxidizing agent. A fully oxygen-balanced mixture consisting of 86.5% tetranitromethane and 13.5% toluene has a density of 1.45. It is a powerful explosive (p. 591, Vol. I).

According to Médard and Sartorius [10] the solution of 33.5% dinitrotoluene, 50.0% nitric acid and 16.5% water in a glass tube 30 mm dia. can detonate at the rate of 6700 m/sec. The solution of 47.0% TNT, 50% nitric acid and 3.0% water in an aluminium tube 40/50 mm dia. detonated at the rate of 7500 m/sec.

Andrussow [11] described Nišalit, a mixture of 79.5% nitric acid (99%) with 20.5% acetonitrile. It develops the heat of detonation of 1670 kcal/l., gas volume $V_0 = 708.0$ l./kg and calculated explosion temperature is 4200°K. Its rate of detonation (density 1.27 at 15°C) is 6250 m/sec and its lead block expansion 450 cm³.

The author suggested another mixture—Disalit:

22% of dimethyl ether
77% of HNO₃
1% of water

He also suggested similar mixtures containing perchloric instead of nitric acid: Niperchlorit and Diperchlorit, respectively.

MIXTURES WITH HYDROGEN PEROXIDE

The Germans used hydrogen peroxide of 80–85% concentration, alone or in mixtures with combustibles, as a fuel for the big V2 rockets during World War II. The utilization of hydrogen peroxide for rocket propulsion and the explosive properties of hydrogen peroxide and its mixtures will be discussed in later sections (pp. 299, 307).

MIXTURES WITH LIQUID OXYGEN (OXYLIQUITS)

These substances are reviewed together with mining explosives. Their use for rocket propulsion will be considered in the section on p. 309.

LIQUID ROCKET PROPELLANTS—PROPERGOLS

The liquid explosives of the type outlined above may serve not only as high explosives but also as propellants for rocket propulsion. Liquids which are not explosives in the strict sense, but which undergo violent decomposition under certain conditions, with heat emission and gas evolution, may also be used for this purpose. The liquids employed for rocket propulsion are called propergols.

The Germans were the first to use them during World War II. The use of concentrated (80–85%) hydrogen peroxide alone, or to a lesser extent, in a mixture with such oxidizing agents as nitric acid, nitrogen dioxide, tetranitromethane, or liquid oxygen, was an innovation.

According to the classification suggested by R. Levy [12] the following types of propergols may be distinguished:

(1) CATERGOLS, i.e. liquids which are decomposable by the action of catalysts, e.g. hydrogen peroxide, decomposed by permanganates.

(2) HYPERGOLS, i.e. systems composed of several (two, at least) liquids which when mixed react spontaneously, usually after a certain induction period (e.g. a mixture of petrol with an admixture of aromatic amines which reacts spontaneously with nitric acid). For practical purposes the induction period of hypergols should be as short as possible—at any rate shorter than 0.1 sec.

Propergols may also be classified according to their homogeneity:

(1) MONERGOLS, i.e. monophasic systems composed of at least two components, one of which is an oxidant, the other a fuel, e.g. a solution of methyl nitrate (oxidant) with methyl alcohol (combustible).

(2) LITHERGOLS, i.e. polyphasic, at least biphasic systems, one of the phases being liquid, another solid, e.g. carbon and liquid oxygen.

MIXTURES WITH NITROGEN DIOXIDE

Nitrogen dioxide can be used together with a combustible substance as a liquid propellant (propergol) for rockets. A mixture of hydrocarbons e.g. petrol or paraffin, may serve as the fuel.

On explosive decomposition the stoichiometric mixture of N_2O_4 with paraffin gives a considerable amount of heat: approximately 1560 kcal/kg.

Since the course of interaction of nitrogen dioxide and paraffin may often be too slow, to facilitate and speed it up a substance that readily reacts with nitrogen dioxide, e.g. aniline, should be added to the paraffin.

Nitrogen dioxide is noteworthy as an oxidant rich in oxygen (it contains 69.5% by weight of oxygen and 1.01 kg of oxygen per 1 l. of substance). However, the physico-chemical properties of nitrogen dioxide, such as its relatively high freezing point ($-10.2^\circ C$) and a low boiling point ($+22^\circ C$) limit its direct use as an oxidant.

On the other hand, nitrogen dioxide has proved to be a valuable component of propergolic mixtures in which nitric acid is an essential oxidant. Nitric acid containing approximately 20% N_2O_4 is a particularly valuable oxidant as explained below.

MIXTURES WITH NITRIC ACID

Mixtures of concentrated nitric acid with combustible substances have recently found wide application as liquid propellants for rockets (propergols).

The first attempts to use them were made by the Germans during World War II.

Nitric acid has many advantages as a component of these mixtures, being readily available from large-scale manufacture.

The physico-chemical properties of the chemically pure substance are described in Vol. I, p. 6.

The high specific gravity of nitric acid, its high oxygen content (76% by weight), low freezing and negative heat of formation all are very advantageous for its use as an oxidant in propergols. Its disadvantage lies in its corrosive action.

For practical purposes commercial nitric acid, containing 2-4% of water, is employed. Its freezing point is lower than that of the pure form (a 10% content of water in HNO_3 lowers the freezing point to $-68.5^\circ C$; a higher content of water lowers this temperature to a lesser extent). Propergols containing nitric acid belong to the hypergol group, i.e. the mixtures which react spontaneously.

Since the reaction of nitric acid alone with a fuel such as petrol or paraffin occurs fairly slowly with a long induction period (longer than 0.1 sec) various substances are added to the nitric acid or the hydrocarbon component to speed up the reaction or induce its spontaneous initiation.

Since nitric acid, especially "red" fuming nitric acid "RFNA" which contains a small amount of nitrogen oxides, reacts vigorously with aromatic amines, during World War II the Germans employed solutions of these amines (e.g. aniline or phenylenediamine) in benzene or xylene as the combustible component. They added a small amount of ferric chloride as a reaction catalyst to the nitric acid. It was also shown that the addition of vinyl ethers to amine solutions reduces the induction period.

To improve the properties of nitric acid as a component of propergols the following admixtures were used, or recommended:

(1) Nitrogen dioxide. This substance alone may be used as an oxidant, though it has some disadvantages, as outlined above. The addition of nitrogen dioxide to nitric acid facilitates enormously the reaction of the latter with many organic compounds, including amines. Moreover it also lowers the freezing point of the nitric acid. The lowest freezing point ($-73^\circ C$) is attained by a solution composed of 82% HNO_3 and 18% N_2O_4 . Nitric acid containing 20% N_2O_4 is employed most frequently.

According to Canright [13] nitric acid becomes "stabilized" by the presence of nitrogen dioxide and water. Such nitric acid remains unchanged during prolonged storage at an elevated temperature.

(2) Mineral acids. Corrosion by nitric acid can be reduced by the addition of sulphuric acid (up to 10%).

It was found (according to Canright [13]) that the addition of small amounts of hydrogen fluoride to nitric acid considerably reduces its corrosive action on aluminium and stainless steel since these metals become coated with a layer of fluorides.

(3) Mineral salts accelerating the combustion reactions. Apart from ferric chloride, which was discussed above, the use of other salts has also been suggested. Grollier-Baron and Wessels [14], for instance, suggest the addition of 4% potassium dichromate to nitric acid in non-hypergolic propergols formed from nitric acid and petrol. According to these authors, at a temperature of 670°C and when the reagents are injected into the combustion chamber at a rate of 10.3 m/sec, a mixture of nitric acid with petrol is ignited after 23 millisecc; at an injection rate of 6.6 m/sec ignition occurs after 33 millisecc. At 920°C and an injection rate of 6.6 m/sec the induction period is 31-35 millisecc.

If nitric acid with 4% potassium dichromate is used at 650°C and the injection rate is 10.3 m/sec, the induction period is 5.5 millisecc and at an injection rate of 5.3 m/sec it is 3.6 millisecc. At 850°C and a rate of 6.6 m/sec the induction period is shorter than 1 millisecc.

In mixtures containing nitric acid various fuels may be employed. Fuels used for hypergolic ones, i.e. those which autoignite on mixing, differ essentially from those used in other mixtures. In hypergolic mixtures, fuels are used which react violently with nitric acid, e.g. aliphatic or aromatic amines, furfuryl alcohol, mercaptans, hydrazine etc. It is also advisable to add surface-active substances to the mixture-

Fuels for mixtures with nitric acid

The following fuels are already in use or recommended for employment in mixtures with nitric acid.

Aliphatic hydrocarbons: petrol, paraffin. In the U.S.A. several types of combustibles for liquid propellant jet aircraft are used. One of them, i.e. JP-4, is employed for rocket propulsion, with nitric acid as an oxidizing agent (it can also be used with hydrogen peroxide or liquid oxygen). The specification of JP-4, is as follows:

Specific gravity at 15.5°C	0.764
Vapour pressure at 38°C	134-160 mm Hg
Fractionation:	
10% distills up to	84-102°C
50% distills up to	142-147°C
90% distills up to	209-227°C

Content of aromatic hydrocarbons	10-12%
Bromine number	1.4
Aniline point	58°C
Ignition point	-13.8°C
Freezing point	-60°C
Heat of combustion	10,400 kcal/kg

Aliphatic hydrocarbons are seldom used separately due to their relatively sluggish reaction with nitric acid. The ignition capacity of hydrocarbons may be increased by dissolving in them aromatic amines or, as the Germans did in earlier experiments, vinyl ethers.

The effect of aromatic amines, however, has been the subject of much controversy. Thus, according to Grollier-Baron and Wessels [14] the addition of 10% aniline to petrol has no obvious influence on the length of the induction period. E.g. if nitric acid containing 4% potassium dichromate is used with petrol containing 10% aniline at 620°C, and a rate of injection is 10.3 m/sec, the induction period is 3.3 millisecc; at a rate of injection of 5.3 m/sec it is 24 millisecc.

Amines. Amines were the first ingredients to be used in hypergols. A mixture of 50% xylidine with 50% triethylamine is the most widely used.

According to Fedosyev and Sinyaryev [15] this mixture, with 98% nitric acid in stoichiometric proportions has the following physico-chemical constants:

Specific gravity	1.32
Heat of reaction	1500 kcal/kg or 1800 kcal/kg
Gas volume	784 l./kg
Explosion temperature approximately	2710°C

Amines with furfuryl alcohol. The commonest of these mixtures is that with 80% aniline and 20% furfuryl alcohol. Fedosyev and Sinyaryev quote the following values characteristic of this mixture with nitric acid:

Specific gravity	1.39
Heat of reaction	1520 kcal/kg or 1900 kcal/kg
Gas volume	756 l./kg
Explosion temperature approximately	2780°C

Barrère and Moutet [16] suggest the following mixtures which form hypergols with nitric acid:

- (1) 25% aniline and 75% furfuryl alcohol
- (2) 25% dimethylaniline and 75% furfuryl alcohol
- (3) 25% toluidine and 75% furfuryl alcohol
- (4) 25-50% xylidine and 75-50% furfuryl alcohol
- (5) 25% diethylamine and 75% furfuryl alcohol
- (6) 25% triethylamine and 75% furfuryl alcohol

Mixtures (2) and (4) react most easily. They have the shortest induction periods, of 18 and 20 millisecc, respectively.

The least reactive are mixtures (5), (6) and particularly (2), with induction periods of 55, 61 and 96 millisecc, respectively.

The same authors studied a mixture of nitric acid with furfuryl alcohol. In reactivity it occupies a position midway between the above mentioned groups with an induction period of 33 millisecc. Similar results were obtained by Kilpatrick and Baker [17] when studying the reaction of furfuryl alcohol with colourless nitric acid.

Mercaptans. McCullough and Jenkins [18] investigated the possibility of the use of mercaptans, by-products of petroleum refining. The mixture of mercaptans contains as chief ingredients:

Propyl mercaptan	27.8% mol.
Butyl mercaptan	65.3% mol.
Amyl mercaptan	6.6% mol.

and traces of hexyl mercaptan.

They employed 96.5% nitric acid or an acid containing 22% of N_2O_4 and 1% of water. The experiments indicated that mercaptans could be used as the combustible component in nitric acid hypergols.

Hydrazine. Concentrated hydrazine (96%) reacts spontaneously with nitric acid. According to Kilpatrick and Baker [17] reaction with 96% colourless nitric acid occurs with a delay of 5.0 ± 1.7 millisecc, whereas with fuming nitric acid (containing 24% N_2O_4) there is a delay of 3.1 ± 1.4 millisecc. Hydrazine of 71.5% concentration gives a delay of about 37 millisecc with either acid.

In another series of experiments on using a molar ratio $\frac{HNO_3}{N_2H_4} = 2.87$ and a rate of injection of 9.2 m/sec these authors obtained an induction period of 0.2 millisecc.

In addition to the foregoing tests they examined the possibility of using liquid ammonia with an admixture of 9 or 14% hydrazine as a combustible component in a mixture with nitric acid containing 24% N_2O_4 . The induction period was 14 or 6–10 millisecc, respectively.

The properties of hydrazine including its explosive properties will be discussed further.

Ammonia. Lewis, Pease and H. S. Taylor [19] and Altman and Penner [20] showed that the system liquid ammonia–nitric acid may be transformed into a hypergolic system by the addition of an alkali metal, e.g. lithium, to the ammonia.

Surface-active substances. Bernard's [21] investigations showed that the addition of surface-active substances (wetting agents) to the fuel may reduce the induction period prior to the ignition of hypergols.

The author quotes the following figures which illustrate the effect of the addition of sodium alkyl sulphate on the induction period of a mixture of furfural with 98% nitric acid:

Mixture without additions	29.9 millisec
Addition of 0.5% sodium alkyl sulphate to furfuryl alcohol	14.4 millisec
Addition of 0.5% sodium alkyl sulphate to nitric acid	22.7 millisec

TABLE 63

CHARACTERISTIC PROPERTIES OF FUELS WITH NITRIC ACID ACCORDING TO BELLINGER, FRIEDMAN, BAUER, EASTES AND BULL [22]

Composition	Content of combustibles %	Heat of reaction kcal/kg	Density	Pressure in combustion chamber atm	Flash point °C	Specific impulse sec*
Nitric acid (60%) + nitrogen dioxide (40%) + aniline		1535	1.45	20	2707	225
Nitric acid + aniline	26.6	1440		21	2760	218
Nitric acid + furfuryl alcohol	34.5		1.37	21	2620	214
Nitric acid + hydrazine	38.5		1.28	21		243

* The specific impulse I_s is measured in kg (or lb) of pressure exerted by kg (or lb) of fuel per sec. Hence specific impulse is expressed in seconds.

Nitroparaffins. Nitroparaffins, such as nitromethane and tetranitromethane, may also act as constituents of propergols, although there is obviously an essential difference in employing these two substances, resulting from their chemical and explosive properties.

Nitromethane (Vol. I, p. 579) may be used as a monergol propellant. However its negative oxygen balance may be reduced by the addition of liquid oxidants, e.g. of tetranitromethane to form a bipropellant. In practice, however, nitromethane decomposes too slowly, and it is difficult therefore to obtain hypergolic mixtures from it. To facilitate and accelerate the decomposition of mixtures with nitromethane it is necessary to add a catalyst, such as a salt of chromic acid.

Higher nitroparaffins such as nitroethane, and 2-nitropropane may be used as constituents of rocket propellants but rather in the capacity of a fuel, e.g. in mixtures with nitric acid, hydrogen peroxide, or liquid oxygen. Research by Tait, A. E. Whitaker and Williams [23] showed that the combustion of stoichiometric mixture of 2-nitropropane with 98% nitric acid in a closed bomb is maintained spontaneously under pressure above 10 atm. The rate of burning depends on the pressure. For pressures in the ranges 14–70 and 70–140 atm (Fig. 78) the increase in rate of burning as a function of pressure differs significantly. This indicates a difference in the mechanism of the combustion reaction at these two pressure ranges.

Among other nitroparaffins isomeric dinitroethanes are also recommended (Wood [24]):

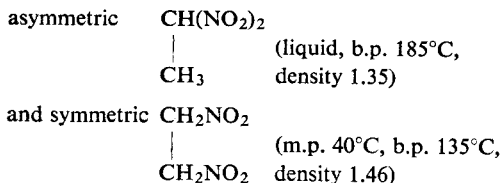

These substances have explosive properties and may be employed as monopropellant propergols. However, symmetric dinitroethane does not seem to be stable enough (Vol. I, p. 394).

Tetranitromethane is of a different nature, being largely an oxidant.

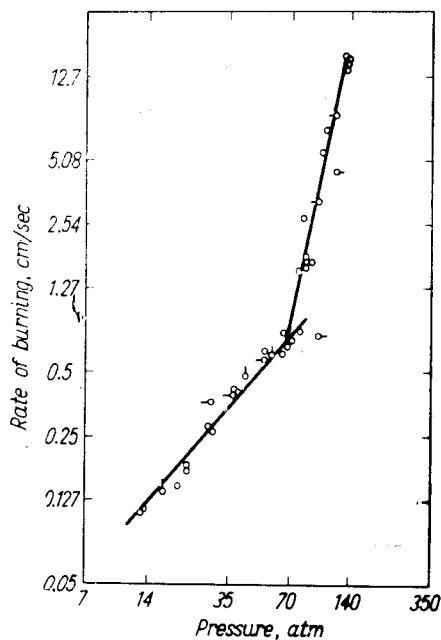

FIG. 78. The relation between the rate of burning of the stoichiometric mixture of 2-nitropropane with nitric acid and the pressure (according to Tait, A. E. Whittaker and Williams [23]).

During World War II the Germans experimented with liquid mixtures consisting of tetranitromethane and combustibles as a liquid fuel for the propulsion of the big V2 rockets.

The greatest advantage of tetranitromethane as an oxidant lies in its high density (1.64 at 20°C). With its high content of oxygen (65.3% by weight) and high density, one litre of tetranitromethane contains 1.07 kg of oxygen, i.e. slightly less than liquid oxygen at a temperature of -183°C (1.14 kg of oxygen per litre). Considering that a molecule of tetranitromethane itself contains a certain amount of combustible material in the form of a carbon atom, it is possible to calculate the oxygen content in the oxidizing part of the molecule only, i.e. in NO_2 groups. According to the calculations of Tschinkel [25] the density of nitro groups in tetra-

tromethane is 1.484 at a boiling point of 126°C, and the oxygen content 1.16 kg per one litre of nitro groups, i.e. higher than liquid oxygen alone.

Owing to these properties a mixture of tetranitromethane with paraffin is preferable to mixtures containing other oxidizing agents. The explosive decomposition of the tetranitromethane mixtures with petroleum hydrocarbons in stoichiometric

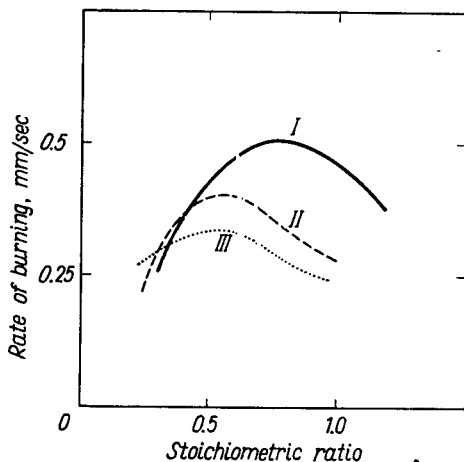

FIG. 79. The rate of burning of mixtures of tetranitromethane with hydrocarbons: I—cyclohexane, II—iso-octane and III—n-heptane (according to Behrens [27]).

proportions gives a high heat effect, viz. 1620 kcal/kg (according to Fedosyev and Sinyaryev [15]).

The disadvantage of tetranitromethane lies in its high freezing point (+13.8°C). The Germans suggested lowering this temperature by the addition of nitrogen di-

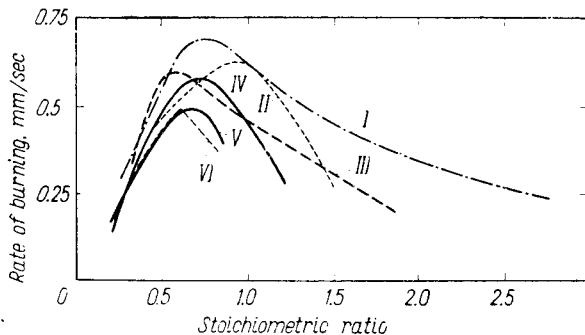

FIG. 80. The rate of burning of mixtures of tetranitromethane with alcohols: I—n-hexanol, II—n-octanol, III—n-butanol, IV—n-propanol, V—isopropanol, VI—isobutanol (according to Behrens [27]).

xide which, with 20% N_2O_4 , freezes at $-14^\circ C$, and with 35% N_2O_4 at $-30^\circ C$. Finally, they evolved a mixture for V2 propulsion having a composition: 30% N_2O_4 and 70% tetranitromethane.

The disadvantages of this mixture are its high vapour pressure resulting from the low boiling point of nitrogen dioxide, and its erosiveness.

According to Hannum [26] tetranitromethane mixtures with nitromethane are desirable for practical purposes. E.g., a mixture containing 10% nitromethane freezes at 0°C, whereas with 20% nitromethane the freezing point is -14°C, and with 35% nitromethane it is low as -30°C.

Among other additives, methyl nitrate (Tschinkel [25]) may be employed, or substances safer to handle, such as methanol and ethylene glycol monoethyl ether.

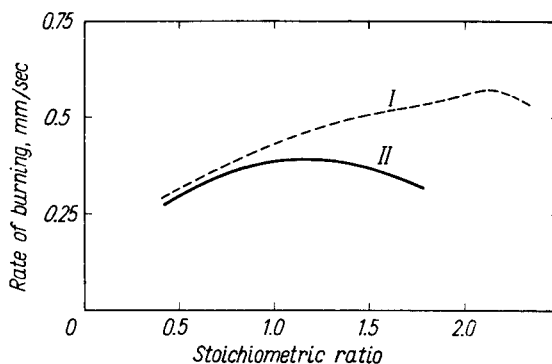

FIG. 81. The rate of burning of mixtures of tetranitromethane with benzaldehyde (I) and nitrobenzene (II) (according to Behrens [27]).

Behrens [27] examined the rate of burning in glass tubes of 5.5 mm dia. of several mixtures of tetranitromethane with a number of organic substances: hydrocarbons, alcohols and aldehydes. All mixtures showed a maximum of the rate of burning at a certain stoichiometric ratio. Figures 79, 80 and 81 give typical curves of mixtures with hydrocarbons, alcohols and benzaldehyde or nitrobenzene, respectively.

Schwob [28] made an extensive study of burning and detonation of mixtures of tetranitromethane and petrol. He found that burning can pass to detonation when the tetranitromethane content is 65–95%. The burning of these mixtures should be considered as dangerous.

However, the limits of explosibility of the mixtures under the action of detonators or impact are much wider: only the mixtures with tetranitromethane content below 40% should be considered as non-explosive.

Hazards associated with the large-scale manufacture of tetranitromethane seriously hinder its use (the plant at Newark, in the U.S.A., which had produced tetranitromethane on a semi-commercial scale, blew up in 1953 and was never rebuilt, so production had to be discontinued).

HYDROGEN PEROXIDE



Among oxidants hydrogen peroxide is one of the richest in oxygen. Pure H_2O_2 contains 47% of available oxygen. A method for the preparation of concentrated aqueous solutions of hydrogen peroxide, containing 80–85% H_2O_2 , has been worked

out since 1943 in Germany by Elektrochemische Werke at Munich. During World War II these solutions were manufactured on an industrial scale under the name of "T-Stoff", either as an oxidant in rocket fuel or (to a less extent) a mono-propellant fuel—cathergol.

The specific gravity of an 80% solution of hydrogen peroxide is 1.34. The solution is fairly stable at room temperature and decomposes only at an elevated temperature (the stability of hydrogen peroxide will be discussed later). To increase the stability of this solution, stabilizing substances such as phosphoric acid and its salts or 8-hydroxyquinoline were added.

The manufacture of 90% hydrogen peroxide was started after World War II in the U.S.A. and Great Britain.

N. S. Davis and Keefe quote the following physico-chemical constants characteristic of 90% hydrogen peroxide [29]:

Specific gravity at 20°C	1.39
Viscosity at 18°C	11.62 cP
Vapour pressure at 30°C	5 mm Hg
Freezing point	-11.1°C
Boiling point	175°C
Heat of formation ($-\Delta H_f$)	
of liquid	45.16 kcal/mole
of vapour (100% H ₂ O ₂)	33.29 kcal/mole
Specific heat (between 0 and 18.5°C)	0.58 cal/g°C
Heat of vaporization	ca. 330 kcal/kg
Surface tension at 18°C	75.53 dyne/cm
Conductivity at 25°C	
of the chemically pure product	2×10^{-6}
of a commercial product	10×10^{-6}
Refractive index at 20°C	1.398
Non-volatile residue in a commercial product	0.005%

(Thermal analysis of the system hydrogen peroxide-water is given on Fig. 82.)

Chemically pure hydrogen peroxide can be stored for a long time without noticeable decomposition. Loss on storage of hydrogen peroxide may amount to 1% per annum.

Shanley and Greenspan [31] report the following relationship between the decomposition of 90% hydrogen peroxide and temperature (Table 64).

TABLE 64

Temperature °C	Approximate rate of decomposition
30	1% per annum
66	1% per week
100	2% per 24 hr
140	Rapid decomposition

Slight amounts of impurities may accelerate the decomposition enormously. The effect of various substances on the decomposition of 90% hydrogen peroxide at 100°C is tabulated below.

TABLE 65

Substance added	Quantity added mg/l.	Loss of H ₂ O ₂ over 24 hr at 100°C %
Without additive	—	2
Al ³⁺	10	2
Sn ⁴⁺	10	2
Cr ³⁺	0.1	96
Cu ²⁺	0.1	85
Fe ³⁺	1.0	15
Zn ²⁺	10	10

(On the accelerating action of hydrogen on H₂O₂—vapour see p. 303.)

Hydrogen peroxide is more stable in an acidic medium than in an alkaline one, and acids are therefore used as stabilizers. Apart from phosphoric acid, already mentioned, boric acid, oxalic acid etc. may also be used.

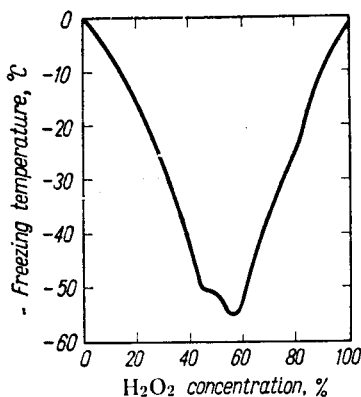

FIG. 82. Freezing temperatures of binary system H₂O₂-H₂O [30].

Experiments have shown that the best construction material for the storage of hydrogen peroxide is high purity (99.6%) aluminium. Aluminium containers should be thoroughly cleaned to remove any traces of organic impurities, and washed first with a solution of caustic soda and then with water and 10% sulphuric acid, over a period of several hours. Finally the acid is washed out with distilled water, after which it is desirable to re-wash the container with hydrogen peroxide. Tanks and containers for hydrogen peroxide should be provided with safety valves, that are ruptured by the excessive pressure produced if the peroxide decomposes.

Special care should be taken to prevent hydrogen peroxide from coming into contact with copper, chromium and lead.

Fittings, pumps, and pipelines can be made of certain types of stainless steels which can be allowed to remain in contact with hydrogen peroxide for relatively short periods, i.e. a few days.

A number of polymers, in particular teflon, polyvinyl chloride and, to a lesser extent, polyethylene do not provoke the decomposition of peroxide.

If, as a result of the presence of some impurities in a vessel containing hydrogen peroxide, decomposition is hastened, it is advisable to add an additional quantity of stabilizer, i.e. phosphoric acid. If this proves inadequate, then, according to Shanley and Greenspan [31], it is necessary to dilute the hydrogen peroxide with water to 67% concentration when it is no longer dangerous, otherwise, violent decomposition may occur and the container may blow up.

When handling large quantities of hydrogen peroxide it is necessary to wear protective goggles, overalls made of protective fabric (an apron of polyvinyl chloride), rubber gauntlets and boots, since severe burns are caused if it comes into contact with the skin.

As previously mentioned, concentrated hydrogen peroxide is used as a cathergol-type monopropellant fuel.

During World War II the Germans employed 80–85% hydrogen peroxide for launching pilotless V2 aircraft and for bringing into operation a mechanism feeding the oxidant and the combustible from their storage tanks into the combustion chambers of V1 aircraft and V2 rockets. This application is based on the decomposition reaction of hydrogen peroxide:

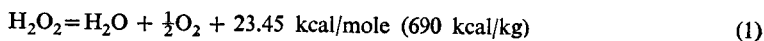

Decomposition was initiated by the addition of a concentrated aqueous solution of calcium and sodium permanganate to the hydrogen peroxide. The use of potassium permanganate proved ineffective since KMnO_4 is insufficiently soluble in water and the solution contains inadequate MnO_4^- ions for rapid initiation of the reaction.

According to Ley [32] the British "Sprite" rocket serving the A.T.O. (assisted take-off) of the "Comet" jet aircraft has a similar propulsion unit, i.e. it contains a charge of 136 l. of hydrogen peroxide and about 9.5 l. of a catalyst solution, most probably permanganate.

The use of hydrogen peroxide as a mono-propellant of the cathergol type is based on the following thermochemical data for hydrogen peroxide of 86 and 100% concentration (by weight) (Wood [24], Table 66).

As these characteristics show, the heat of decomposition is considerably higher than the heat of vaporization. The vapour so produced is superheated and, at the same time the temperature of adiabatic decomposition is high enough to make possible a useful expansion of gases. The efficiency of such a fuel, however, is negligible. Its specific impulse does not exceed 130 sec.

A considerable amount of work [33] was dedicated to studying the mechanism of decomposition of hydrogen peroxide in the vapour phase. It was soon recognized that the difficulty of obtaining reproducible results is due to the action of the vessel surface producing the heterogeneous reaction. Baldwin and Mayor [34] have shown that the kinetics of the slow reaction between H_2 and O_2 in aged boric acid-coated vessels could only be explained by assuming that the aged surface was extremely inert to both HO_2 and H_2O_2 . Baldwin and Brattan [35] studied the reaction of gaseous decomposition of hydrogen peroxide in an aged boric acid-coated vessel over a range of temperatures 260–520°C. They found the decomposition and the dependence of rate on total pressure being of the first order.

TABLE 66
THERMOCHEMICAL DATA FOR HYDROGEN PEROXIDE

Item	Concentration (%)	
	86	100
Heat of decomposition (kcal/kg)	600	690
Heat of vaporization (kcal/kg)	395	370
Adiabatic decomposition temperature (°C)	650	980
Gas volume on complete adiabatic decomposition (l.)	4900	6400

The results are in agreement with the work of Giguère and Liu [36], Forst [37] and Hoare *et al.* [38].

Baldwin and Brattan also found that the addition of hydrogen to H_2O_2 vapour considerably increases the rate of decomposition of the latter.

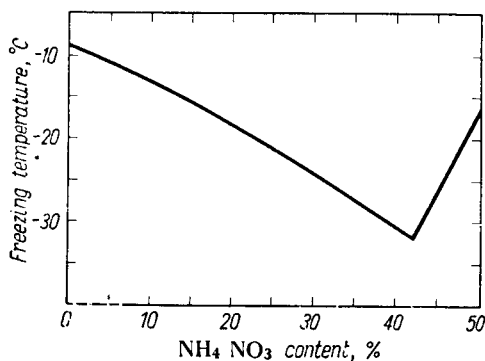
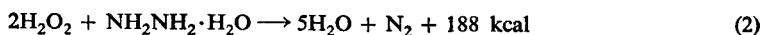

FIG. 83. Freezing temperatures of binary system H_2O_2 - NH_4NO_3 [30].

Concentrated hydrogen peroxide was widely used during World War II as an oxidant in a mixture with hydrazine hydrate, for the propulsion of V2 rockets. Hydrogen peroxide mixed with hydrazine reacts spontaneously according to the equation:



As reaction is preceded by a certain delay, this induction period was reduced by the addition of copper salts, e.g. potassium cuprocyanide $K_3Cu(CN)_4$. This substance was supplied to the system dissolved in the hydrazine hydrate. It was found that potassium cuprocyanide reacts with hydrazine even at room temperature to form metallic copper which, if deposited in the pipelines, may cut off the flow of hydrazine into the combustion chamber. To prevent this the system was modified so that hydrazine hydrate flowed from the tank into the combustion chamber through a cartridge containing cupric nitrate, which dissolved in hydrazine hydrate in a sufficient quantity to accelerate the reaction (hydrazine and its reaction with H_2O_2 will be discussed in more detail further on).

During World War II the Germans used a mixture of hydrogen peroxide with Diesel oil in torpedo and submarine propulsion.

An idea of considerable interest advanced by Paushkin [30] was the use of a solution of ammonium nitrate in concentrated hydrogen peroxide as an oxidant. A solution consisting of 40% NH_4NO_3 and 60% of 92% hydrogen peroxide seems to be particularly attractive. Its freezing point is approximately $-30^\circ C$ (Fig. 83).

Explosive properties of hydrogen peroxide and its mixtures

The exothermic character of the decomposition of hydrogen peroxide indicates that hydrogen peroxide itself may have explosive properties. In fact 99.6% hydrogen peroxide gives a lead block expansion of 75–80 cm^3 . In a steel tube with 34–40 mm

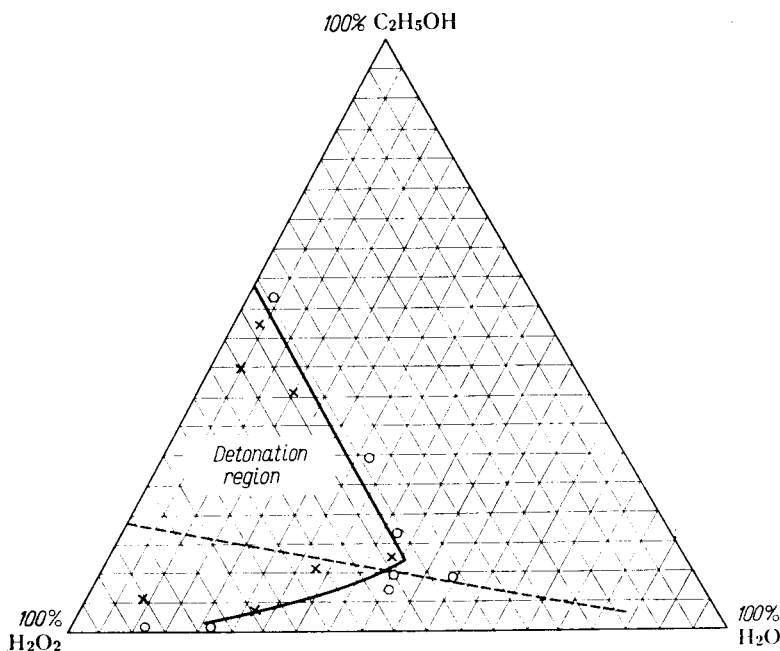

FIG. 84. Diagram of explosive properties of ternary mixtures $H_2O_2-H_2O-C_2H_5OH$, according to Shanley and Greenspan [31]; x — detonation, o — no detonation.

dia. 94–100% hydrogen peroxide detonates completely when initiated with 50 g of compressed pentaerythritol. With 92% hydrogen peroxide, however, detonation is propagated only to 100 mm along the tube, away from the detonator.

Ninety per cent hydrogen peroxide does not detonate at all (Paushkin [30]).

Investigations into the explosive properties of ternary mixtures of hydrogen peroxide and water with various organic substances, carried out by Shanley and Greenspan [31], aroused much interest. On the basis of their results triangular diagrams may be constructed for a number of systems: (a) hydrogen peroxide, (b) water, (c) organic substance (such as ethanol, glycerine, acetone). In Fig. 84 a typical diagram is shown, characteristic of mixtures with ethanol. The other diagrams are very similar. In general, only mixtures containing a limited amount of water possess explosive properties.

All the three organic substances mentioned above, when dissolved in 80% H_2O_2 , give mixtures detonated by a detonating cap and a booster with a rate of about 7000 m/sec, which drops to 2300 m/sec as the concentration of hydrogen peroxide is reduced. When weakly initiated they detonate with a rate of 750 m/sec only (Schumb, Satterfield and Wentworth [39]).

A monograph on hydrogen peroxide was written by Schumb, Satterfield and Wentworth [39].

HYDRAZINE

Physico-chemical and explosive properties

Anhydrous hydrazine melts at $2^\circ C$ and boils at $113.5^\circ C$, its density is 1.0253 g/cm^3 (Walden and Hilgert [40]); 1.0231 (Semishin [41]).

With water it forms hydrazine hydrate $NH_2 \cdot NH_2 \cdot H_2O$ with a melting point of $-51.7^\circ C$ and a density d_4^0 of 1.048 (Semishin).

Hydrazine is an endothermic substance. The heats of formation $-\Delta H_f$ of anhydrous hydrazine and the hydrate are, according to Hughes, Gilbert *et al.* [42]:

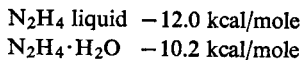

Roth [43] found the heat of formation of liquid hydrazine at $25^\circ C$ to be $-\Delta H_f = 13.8 \text{ kcal/mole}$.

According to Hughes, Gilbert *et al.* the heat of combustion of the anhydrous substance (liquid) is $-\Delta H_c = 148.6 \text{ kcal/mole}$.

Anhydrous hydrazine burns in air. On heating hydrazine above boiling point, thermal decomposition of gaseous hydrazine takes place at $250\text{--}310^\circ C$ (Elgin and Taylor [44]; Askey [45]). Bamford [46] ascertained that hydrazine is decomposed by an electrical spark, while Elgin and Taylor established that hydrazine vapour is decomposed by ultra-violet irradiation (also Wenner and Beckmann [47]).

According to Bamford, the thermal decomposition and explosion of hydrazine is expressed by equations in which free radicals are present:

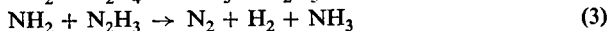
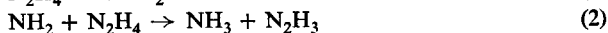
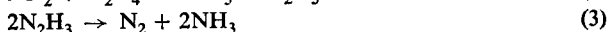
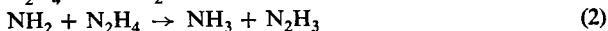

In addition, side reactions may occur:

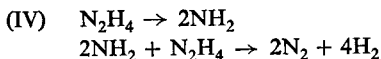
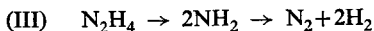

In spite of the ease with which the decomposition of hydrazine has been established, its explosive properties have been not established with certainty.

In relatively recent times Scott, Jones and Lewis [48] made detailed studies of the explosive properties of hydrazine and 85% hydrazine hydrate. In the drop test, neither hydrazine nor hydrazine hydrate were exploded by a very strong blow (5 kg from 1 m height). Hydrazine and its hydrate are also insensitive to friction. The authors' attempts to determine the rate of detonation of hydrazine in pipes also failed since hydrazine is initiated by a detonator with difficulty. The reaction in the ballistic pendulum, of charge of anhydrous hydrazine initiated by No. 8 detonator, was 135% of that produced by TNT. Under these conditions hydrazine hydrate does not detonate at all.

Scott, Jones and Lewis examined the ignitability of hydrazine and hydrazine hydrate by various means.

TABLE 67

Material from which the vessel is made	Atmosphere	Hydrazine		85% hydrazine hydrate	
		Ignition temperature °C	Induction period sec	Ignition temperature °C	Induction period sec
Pyrex glass	Air	270	3.9	292	4.2
	Oxygen	204	4.9	218	5.3
Platinum	Air	226	3.0	338	3.8
	Oxygen	30	6.0	132	19.7
Fe ₂ O ₃ (powdered in a glass vessel)	Air	23	0.0	—	—
	Nitrogen	23	0.0	—	—
Iron	Air	132	0.0	—	—
	Nitrogen	131	0.0	—	—
Stainless steel	Air	160	2.0	—	—
	Nitrogen	415	0.9	—	—

They established that an electrical spark having an energy of 12.5 J when passed through unconfined liquid hydrazine produces no signs of decomposition. Conversely, hydrazine or its hydrate in a confined space undergoes explosive decomposition under the influence of a spark stronger than 2.63 J.

In an atmosphere of oxygen the ignition of hydrazine (but not its hydrate) takes place at a lower temperature than in air. The ignition temperature is strongly influenced by the material of which the hydrazine container is made.

The authors' [48] numerical data are collected in Table 67. They are valuable indications of the safety measures which should be observed in the storage, transportation and handling of hydrazine. It can be contained in vessels of glass and stainless steel, but under no circumstances in those made of iron. Aluminium containers are also acceptable.

The experiments of Scott, Jones and Lewis on the limits of ignitability of hydrazine vapours are also of great importance. The figures obtained by these authors are tabulated below (Table 68).

The ignition of the gaseous mixture was brought about by an electrical spark.

TABLE 68

Composition of gaseous mixture	Content of (%)		Pressure mm Hg	Temperature °C
	Hydrazine	Other component		
Hydrazine-air	4.67	95.33	757-758	92-101
Hydrazine-nitrogen	38.0	62.0	754	109-112
Hydrazine-helium	37.0	63.0	756-758	105-118
Hydrazine-water vapour	30.9	69.1	689-889	130-135
Hydrazine-heptane	86.8	13.2	404-327	104-133

Hydrazine is a highly toxic substance, injurious to the sight, causing temporary blindness. The lethal dose (LD_{50}) for dogs is approximately 0.05 g/kg of body weight. Salts of hydrazine provoke hyperglycaemia, blood clotting due to dehydration and liver damage.

According to Raciborski [49] some moulds can assimilate hydrazine.

A monograph by Audrieth and Ogg [50] is dedicated to hydrazine.

Oxidation of hydrazine by hydrogen peroxide

This most important reaction—the oxidation of hydrazine—has not yet been investigated fully. Work on the subject has consisted mainly of studies of the kinetics of the process in dilute aqueous solutions. Gordon [51], studying the kinetics of decomposition of hydrazine and hydrogen peroxide, found that the reaction rate depends to a great extent on the pH. Its peak value is reached at $pH=10-11$.

The addition of cobaltic sulphate to the reaction system raises the reaction rate considerably.

Concentrated hydrogen peroxide does not react instantly with hydrazine hydrate, only after a certain induction period. This has been the cause of a number of explosions and accidents, produced by the accumulation of unchanged components and their sudden reaction after the induction period has elapsed.

As previously stated, the addition of a copper salt to hydrazine reduces the induction period practically to zero. The addition of sodium nitroprusside exerts a similar influence.

According to McLarren [52] a mixture with methyl alcohol has frequently been used in rockets, to react with hydrogen peroxide. E.g. in the HWK-59 jet propulsion engine and BP-20 rocket missiles 80% hydrogen peroxide is used as an oxidant together with a combustible consisting of:

Hydrazine hydrate	30%
Methyl alcohol	57%
Water	13%

0.11% of $K_3Cu(CN)_4$ is added to the fuel.

According to Fedosyev and Sinyaryev [15] a mixture of 80% hydrogen peroxide with hydrazine hydrate diluted with methyl alcohol in the ratio of 1 : 1 has the following physico-chemical constants:

Heat of reaction	1020 kcal/kg or 1330 kcal/l.
Specific gravity	1.30
Gas volume	940 l./g
Temperature of explosion	2330°C
Specific impulse	180 sec

Among the reactions of hydrazine used for rocket propulsion that of hydrazine with nitric acid is known.

It is also possible to use hydrazine hydrate alone as a monergol owing to its high heat of decomposition. Energy and gaseous products are provided by decomposition induced by permanganates, commonly used in the solid form.

1,1-DIMETHYLHYDRAZINE (UDMH)

Among the homologues of hydrazine, asymmetric dimethylhydrazine $(CH_3)_2N \cdot NH_2$ is important. It is obtained from dimethylamine by nitrosation followed by reduction

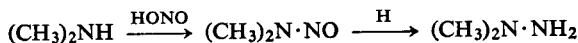

or by a modification of the Raschig method of preparation of hydrazine in the presence of dimethylamine.

It is a colourless liquid with a freezing point of *ca.* $-56^\circ C$, a boiling point of *ca.* $63^\circ C$ and a density of 0.785 g/cm^3 .

The heat of combustion is *ca.* 3580 kcal/kg .

Under the name of "Dimazine" or the abbreviation of UDMH it is used for hypergols by mixing with nitric acid. It may also be used with liquid oxygen.

In the U.S.A. it is employed in "Nike Ajax", "Rascal" and "Vanguard" rockets (Warren [53]).

MIXTURES WITH LIQUID OXYGEN AND OZONE

When V2 rockets were first used a mixture of liquid oxygen with 70% methyl alcohol was employed as a fuel. This mixture, however, is not capable of self-ignition, and it had to be ignited by means of a pyrotechnical mixture giving a hot flame.

Mixtures containing liquid oxygen are less commonly used now for jet propulsion than mixtures with nitric acid. Nevertheless, for obvious reasons, they have much prospect of success considering that liquid oxygen is a 100% oxidant.

A disadvantage of liquid oxygen is that its boiling point is very low (-183°C), and so is its specific gravity at this temperature (1.14). In view of the low boiling point rockets should be filled with this liquid oxidant just before use.

As a combustible, paraffin or alcohols may be employed. Fedosyev and Sinyaryev [15] quote the following physico-chemical constants for typical mixtures with liquid oxygen.

TABLE 69

Fuel	Heat of reaction		Specific gravity	Volume of gases l./kg	Temperature of explosion $^{\circ}\text{C}$
	kcal/kg	kcal/l.			
Paraffin	2200	2200	1.00	650	3280
Ethanol (93.5%)	2020	2000	0.998	789	2980

Investigations into the possibility of using liquid ozone or, strictly speaking, mixtures of liquid oxygen with liquid ozone, have recently been carried out by the Armour Research Foundation in Illinois. According to Platz and Hersh [54] liquid ozone or a mixture of liquid ozone and oxygen may be obtained by introducing oxygen, carefully purified from organic impurities, into the ozonizer, where the mixture is irradiated and the ozone liquified (-111.9°C under atmospheric pressure); the oxygen escapes through an exit pipe. If a mixture of liquid ozone with oxygen is to be obtained the gases discharged from the ozonizer are introduced to the liquid oxygen after being cooled.

Liquid oxygen (100%) and a mixture of ozone with oxygen are stable enough if the oxygen used for producing the ozone contains not more than 0.002% (calculated on CO_2) of organic material.

NITRIC ESTERS

Liquid and volatile nitric esters, being safer to handle and more stable chemically than nitroglycerine or diethylene glycol dinitrate (DGDN), can be employed as monopropellant jet fuels. Among these compounds methyl nitrate should be mention-

ed first (Vol. II, p. 160). It was used for jet propulsion by the Germans during World War II under the name of Myrol either in the pure state or as a methyl alcohol solution (30% of methanol and 70% of methyl nitrate). Recently, another nitric ester, i.e. isopropyl nitrate has been suggested but for the time being there is no further information available about its use. Sometimes ethyl nitrate is also mentioned.

ETHYLENE OXIDE

This compound also deserves attention as a monergol. Its physical constants are: boiling point 11°C, freezing point -112°C, density 0.90. It decomposes exothermically according to the theoretical equation:

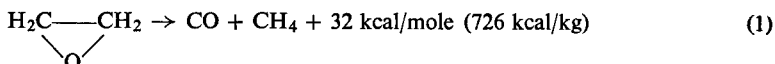

In point of fact the reaction is more complicated and proceeds according to the equation:

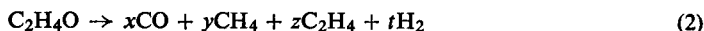

where the coefficients x , y , z and t are less than 1. The heat of this reaction is somewhat lower than for equation (1), but in calorific value, ethylene oxide is on a par with propellants. Table 70 gives the products of decomposition, temperature of explosion and specific impulse according to Glassman and Scott [55] and Kruska [56].

TABLE 70

Pressure in chamber atm	Composition of products (%)				Temperature of explosion °C	Specific impulse sec
	CO	CH ₄	H ₂	C ₂ H ₄		
20	1.0	0.84	0.16	0.08	1015	159
30	1.0	0.86	0.14	0.07	1027	168
40	1.0	0.87	0.06	0.06	1033	174
60	1.0	0.88	0.06	0.06	1039	181

Ethylene oxide has the advantage of being safe to handle since it is not strictly an explosive.

ATTEMPTS TO INCREASE THE ENERGY OF LIQUID MIXTURES FOR ROCKET PROPULSION

Clearly, attempts to increase the energy liberated by liquid mixtures for rocket propulsion are based, in the first instance, on the use of those components (combustible and oxidant) which release as much heat as possible. E.g. the use of ozone as an oxidant has been discussed above (p. 309).

MIXTURES WITH POWDERED METALS

It has been suggested that powdered metals, e.g. aluminium should be added to the combustible component in the form of a suspension. Stettbacher [57], for example, suggested the following equation for the combustion of a mixture of petrol with aluminium suspended in it in stoichiometric proportions:

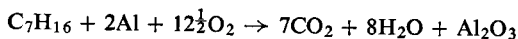

On combustion this mixture gives *ca.* 2545 kcal/kg or *ca.* 2763 kcal/l.

Stettbacher calls attention to the fact that powdered aluminium always contains a certain amount of aluminium oxide (up to 11%), hence the heat of combustion is lower than that theoretically calculated.

The significance of the addition of beryllium to the fuel is still rather theoretical. E.g. paraffin with nitric acid in stoichiometric proportions gives 1440 kcal/kg, whereas the same mixture with 7.2% and 10.0% of beryllium gives a heat effect of 2130 kcal/kg and 2480 kcal/kg, respectively.

BORON, SILICON AND BERYLLIUM COMPOUNDS

The addition of suspensions of metals to the liquid involves difficulty in achieving a homogeneous suspension, and as an alternative the use of organometallic and organometalloid compounds or hydrides has been suggested. These may be combinations of boron with hydrogen, boron with hydrogen and nitrogen, silicon with hydrogen, silicon with hydrogen and nitrogen, which all are predominantly endothermic or only slightly exothermic.

Fedosyev and Sinyaryev [15] report the following properties of the most typical representatives of the above compounds (Table 71).

TABLE 71

Compound		Melting point °C	Boiling point °C	Heat of formation - ΔH_f kcal/mole	Specific gravity
Name	Formula				
Pentaborane	B ₅ H ₉	50*	60*	0*	0.64*
Diborane amine	B ₂ H ₇ N	-66	76	-10*	0.70*
Trisilane	Si ₃ H ₈	-117	53	-20*	0.88*
Trisilyl amine	(SiH ₃) ₃ N	-106	52	-10*	0.895
Beryllium ethyl	Be(C ₂ H ₅) ₂	12	200*	-35*	0.60*

* Approximate figures.

It is to be noted that boranes react with water in such a manner that the latter acts as oxidant, e.g.:

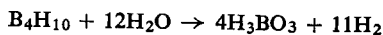

ORGANOMETALLIC COMPOUNDS

Experiments are also being carried out on the addition of organometallic compounds such as lithium ethyl, aluminium trimethyl or triethyl etc. to the fuel. These compounds ignite on contact with the oxygen of the air or with oxidizing agents—components or propergols—hence they can be valuable constituents of hypergols. At the same time they liberate a large amount of heat on combustion and can thus be used for increasing the energy evolved on the combustion of propergols.

FLUORINE AND ITS DERIVATIVES

Recently, the use of fluorine as an oxidant has been considered feasible. E.g. the reaction of fluorine with hydrazine gives a particularly large theoretical specific impulse (I_s) amounting to 298 sec.

Fluorine with hydrogen gives $I_s = 352$ sec, whereas oxygen with hydrogen has a somewhat lower value (342 sec).

Nevertheless it should be borne in mind that the use of liquid fluorine has considerable disadvantages. Its boiling point is -187°C . To prevent corrosion special vessels of nickel alloys surrounded by a jacket filled with liquid nitrogen (boiling point -199.5°C) are required.

Operating with liquid hydrogen as a combustible also creates exceptional difficulties, due to its exceedingly low boiling point (-253°C).

In addition to fluorine itself, fluorine compounds have also been recommended. Chlorine trifluoride (ClF_3) with a boiling point of 12°C and a density of 1.77 g/cm^3 is the most promising for use in rocket propulsion. Its specific gravity is 1.85, heat of formation $-\Delta H_f = 41.0\text{ kcal/mole}$. It is obtainable by the action of fluorine on chlorine in an atmosphere of nitrogen at 280°C , in a reactor of copper or nickel.

During World War II, the Germans developed the production of chlorine trifluoride as an incendiary agent.

Another fluorine compound—nitrogen trifluoride — is interesting theoretically but difficult to manufacture.

Fluorine oxide also merits attention. This is a gas liquefiable at -144.8°C and weakly endothermic. Its heat of formation $-\Delta H_f = -9.2\text{ kcal/mole}$ [58].

Still another compound of great interest is perchloryl fluoride ($\text{ClO}_3 \cdot \text{F}$). It was described in Vol. II. Perchloryl fluoride is distinguished by its high stability; it causes no corrosion of commonly used materials. It reacts vigorously with oxidizable organic compounds.

It reacts with hydrazine. In rockets such a mixture gives a specific impulse I_s of 270.

According to Engelbrecht and Atzwanger [59], Jarry [60], and [61] the physical properties of perchloryl fluoride are as follows:

Melting point	-146°C (-146 ± 2°C)
Boiling point	-47.5 ± 0.5°C (-46.8°C)
Vapour pressure	$\log_{10} P(\text{mm}) = 18.90112 - 1443.467/T$ $-4.09566 \log_{10} T$ (at -120 to -40°C) $\log P(\text{atm}) = 4.46862 - 1010.81/T$ (at -40 to +95.15°C)
Heat of vaporization	4.6 kcal/mole
Liquid density	$2.266 - 1.603 \times 10^{-3} T - 4.080 \times 10^{-6} T^2$ g/ml T
Critical temperature	95.13°C
Critical pressure	53.0 atm
Critical density	0.637 g/cm ³
Heat of formation at 25°C	$-\Delta H_f^0 = 5.12 \pm 0.68$ kcal/mole
Specific heat of liquid	
at -40°C	0.229 cal/g°C
-10°C	0.244 cal/g°C
+50°C	0.290 cal/g°C
$\frac{S_p}{S_v}$ at 24°C	1.12

MIXTURES WITH PERCHLORIC ACID

Perchloric acid (HClO₄) is also recommended as an oxidant for rocket fuels. The anhydrous acid is a liquid with a specific gravity at 20°C of 1.767 and a freezing point of -112°C; it decomposes when heated to 9°C. It can be distilled under reduced pressure (at 16°C under a pressure of 18 mm Hg, at 30°C under a pressure of 50 mm Hg).

Perchloric acid forms easily hydrates:

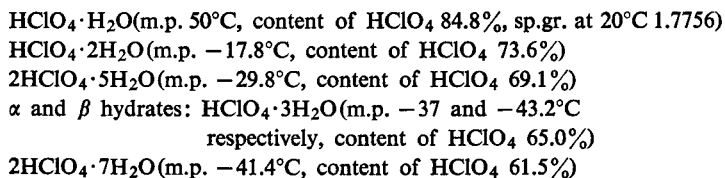

The hydrates of perchloric acid (even lower ones) are judged to be unsuitable as rocket fuels.

The heat of formation of perchloric acid $-\Delta H_f^0$ is 11.1 kcal/mole.

Full decomposition proceeds with heat evolution:

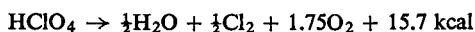

158 kcal are evolved from 1 kg which is not sufficient to make the substance explosive, but the addition of 3% of organic substance to perchloric acid gives an explosive mixture. Some organic substances (amines, unsaturated compounds, cellulose, wood, rubber) are ignited on contact with perchloric acid.

Elliot and Brown [62] made extensive studies of the inflammability of mixtures of perchloric acid with oxidizable substances. Most of the mixtures of 60% perchloric acid when ignited in a confined space burned to detonation. The mixtures with 70% perchloric acid and some of them with 60% perchloric acid could be ignited by impact. Explosion was induced under action of No. 6 detonator on mixtures with 60% perchloric acid with wood meal or cotton and the rate of explosion was found to be 3000 m/sec.

Exposure to irradiation of sunlight **did** not seem to affect the mixtures with 40–60% perchloric acid.

A detailed study was made by Jacquet [63] and Jacquet, Médard and Sartorius [64] of the explosive properties of the three-component system: perchloric acid, acetic anhydride and acetic acid. These solutions are widely used in electropolishing baths [65]. However, Merchant [66] drew attention to the explosive properties of such mixtures. Indeed, a number of explosions of electropolishing mixtures occurred, and that in Los Angeles (O'Connor plant) 1947 was particularly disastrous. Two hundred gallons of a solution of 75 vol.% of 72% perchloric acid and 25 vol.% of acetic anhydride exploded. Seventeen men were killed and one hundred and fifty wounded.

By calorimetric measurements [67] the heat of mixing aqueous perchloric acid (69%) with acetic anhydride in glacial acetic acid was found to be 20.6 ± 1.8 kcal/mole. This is the difference between the heats of hydration of acetic anhydride (34.8 kcal/mole) and of 69% perchloric acid (16.4 kcal/mole):

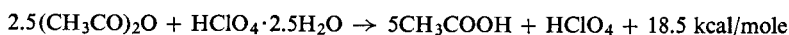

The highest explosive power would correspond to the stoichiometric mixture composed of 66 vol.% of 72% perchloric acid and 34 vol.% of acetic anhydride. It could decompose according to equation:

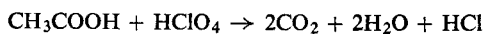

The calculated thermal effect in this reaction (*ca.* 1250 kcal/kg) would fall between those of the explosive decomposition of nitroglycerine and guncotton, and the calculated temperature would be *ca.* 2500°C.

Jacquet, Médard and Sartorius [63, 64] investigated the process of mixing 62.7% perchloric acid (density 1.59) with 100% acetic anhydride. They found that no explosion occurred when vigorous mixing was applied. This was independent of the order of mixing but addition of the acid to the anhydride was suggested to be the less dangerous procedure.

The stoichiometric mixture (mentioned above) was found to be very sensitive to priming. It was detonated by a primer as weak as 0.6 g of mercury fulminate. The rate of detonation, or more precisely of explosion, was variable (this is typical for liquid explosives): 1300–2000 m/sec. Expansion in the lead block was found to be 85 (picric acid = 100) which is the same value as that of dinitrobenzene (88).

Aptitude to detonation decreased with increasing content of acetic anhydride: mixtures containing less than 57 vol.% of perchloric acid (62.7%) could not be detonated.

The sensitiveness to shock was also examined. 50% explosions were obtained when 1 kg weight fall from 1.40 m on a drop of the stoichiometric liquid in a metal capsule.

The ignition of the mixture by red hot wire or with a flame was difficult. Only those richest in acetic anhydride could be ignited at the boiling point. With increasing

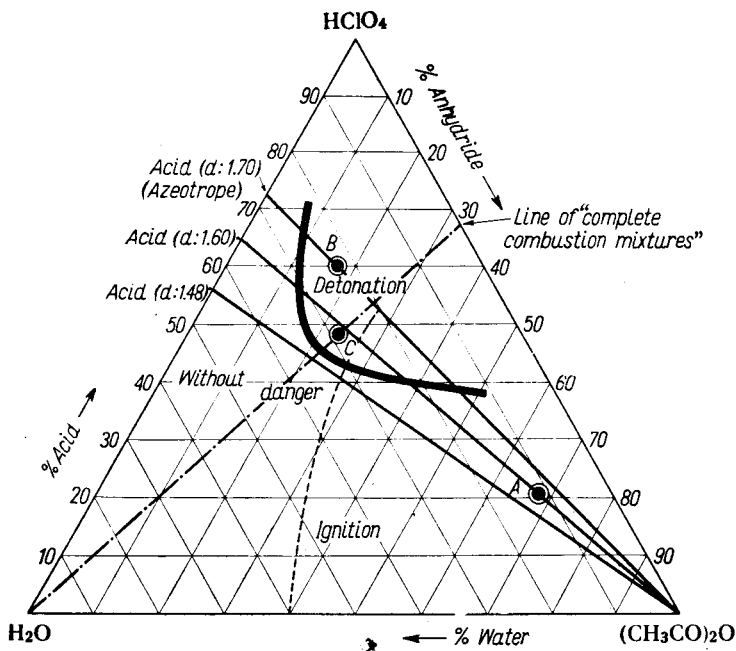

FIG. 85. Explosive properties of perchloric acid-acetic anhydride-acetic acid (and water) mixtures, according to Jacquet [63].

perchloric acid content the ignition became more difficult. The stoichiometric mixture did not burn.

The solutions used for metal polishing (see below) ignited when fine wood shavings were added at 60°C.

Jacquet [63] summarized his results by drawing the triangular diagram (Fig. 85). The stoichiometric mixture is marked by point (C) and the mixture which gave the Los Angeles accident is marked (B). In the ignition zone but outside the region of detonation are most of the compositions usually applied for electropolishing baths. Point (A) corresponds to the mixture in which all the water introduced by 64% perchloric acid reacted with the acetic anhydride to form acetic acid.

Handling and storage of perchloric acid must be done with particular care.

It is well known that anhydrous perchloric acid must never be allowed to come into contact with oxidizable organic substances such as alcohols, wood, cotton, paper, cork and most plastics otherwise ignition or explosion will result.

Anhydrous perchloric acid is liable to explosive decomposition even when free of organic substances. On storage it gradually becomes coloured due to the formation of decomposition products, even in the dark, and in this condition it may explode spontaneously. Anhydrous acid which has become amber coloured (or darker) should therefore be diluted with water immediately and discarded.

Also aqueous perchloric acid may cause fire or explosion [68].

Considerable caution must be exercised in contacting perchloric acid with metals, e.g. the catalytic action has been reported [69] of steel particles in reducing the explosion temperature of mixtures of perchloric acid vapour and hydrogen [69].

REACTIONS OF FREE ATOMS OR RADICALS

Another approach to the problem of increasing the energy of rocket fuels consists of searching for possibilities to operate with combustible (e.g. hydrogen) and oxidizing (e.g. oxygen) elements in the form of atoms (H, O) and not molecules (H_2 , O_2) at the moment of combustion, as reaction of atoms would give a much greater heat effect than the reaction of molecules. These attempts are of no practical significance for the present, since methods for producing free atoms sufficiently concentrated and storable are still unknown.

GENERAL CONSIDERATIONS

In publications including those of Latham, Bowersock and Bailey [70], and Wood [24] the following magnitudes of the specific impulse of various mixtures, currently used and prospective (Table 72) are quoted.

A recent publication [71] suggests mixtures of oxygen difluoride as an oxidizer. This substance can give an I_s as high as *ca.* 400 sec when mixed with hydrogen. The mixture of oxygen difluoride and unsymmetrical dimethylhydrazine has a theoretical specific impulse of *ca.* 330 sec.

A high performance can also be achieved with perchloryl fluoride (Vol. II) and tetrafluorohydrazine as oxidizers.

In selecting the constituents of a fuel every effort should be made to attain the optimum conditions likely to be created by the mixture. The optimum conditions are attained by creating:

- (1) The highest temperature of reaction
- (2) The lowest molecular weight
- (3) The lowest $\frac{S_p}{S_v}$ ratio

TABLE 72

Constituents		Oxidant: combustible ratio	Specific gravity	Specific impulse sec	Remarks
Oxidant	Combustible				
100% nitric acid	Turpentine	4.4	—	221	Fuels most commonly used
Fuming nitric acid (FNA)	Ethanol	2.5	—	219	
FNA	Aniline	3.0	—	221	
FNA	Ammonia	2.2	—	225	
FNA	JP-4	—	—	225	
99% hydrogen peroxide	Ethanol	4.0	—	230	
99% hydrogen peroxide	JP-4	6.5	—	233	
99% hydrogen peroxide	Hydrazine	—	—	245	
Liquid oxygen (LOX)	Ethanol	1.5	0.97	242	
LOX	JP-4	2.2	1.02	248	
LOX	Turpentine	2.2	—	249	
LOX	Ammonia	1.3	—	250	
Hydrogen peroxide	Nitromethane	—	—	227	
N ₂ O ₄	Hydrazine	—	—	249	
N ₂ O ₄	Hydrogen	11.5	0.565	279	
FNA	Hydrogen	12.6	0.60	298	
LOX	Hydrogen	2.9	0.23	345	
70% LOX	JP-4	2.3	—	253	
30% ozone					
100% ozone	JP-4	1.9	—	266	
100% ozone	Ammonia	1.13	—	267	
100% ozone	Hydrazine	0.63	—	277	
Fluorine	JP-4	2.6	—	265	
Fluorine	Ammonia	2.6	—	288	
Fluorine	Diborane (B ₂ H ₆)	5.0	—	291	
Fluorine	Methanol	2.37	—	296	
Fluorine	Hydrazine	1.98	—	298	
Fluorine	Hydrogen	4.5	—	352	
Fluorine	Hydrogen	9.4	0.46	371	
100% ozone	Hydrogen	3.2	—	369	
100% ozone	Hydrogen	2.65	0.23	373	

Tormey [72] quotes the following three examples of mixtures which give the optimum conditions.

(1) Mixture giving the highest temperature:



Flame temperature *ca.* 5240°C

$I_s = 270$

(2) Mixture giving the lowest molecular weight:

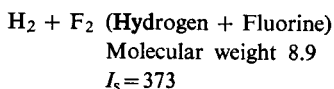

(3) Mixture giving the lowest $\frac{S_p}{S_v}$ ratio:

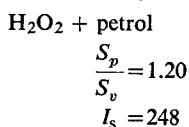

With the reaction of free radicals or atoms much higher magnitudes of specific impulse may be obtained.

TABLE 73
REACTIONS OF HYDROGEN WITH FREE RADICALS

Reagents		Molar ratio H ₂ /R	Specific impulse sec
Hydrogen	Radical R		
H ₂	NH	2.8	410
H ₂	BH	2.2	420
H ₂	CH	5.0	492
H ₂	H	0.5	1040
H	H	—	1280

Still higher magnitudes of specific impulse can be obtained theoretically by using non-chemical reactions, e.g. ions and electrons which arrive in an electric field at a speed close to that of light. Another method is based on the use of photon flux with the speed of light.

Warren [53] quotes the following figures (Table 74):

TABLE 74

Fuel	Specific impulse (sec) max
Chemical	400
Free atoms and radicals	1200
Ions and electrons (from a nuclear reactor)	10 ⁶
Photons (from solar radiation)	10 ¹⁰

FINAL REMARKS

Most of the propulsion systems recorded in Tables 73 and 74 are only suggestions for the future or in development. Some of them would require chemicals which are produced only on a laboratory scale. Others would need chemicals whose properties and methods of production are often insufficiently known.

This is why only a very limited number of liquid compositions is in use.

They are classified into storable and cryogenic liquids [71].

Storable liquids

They remain liquid under normal, ambient operating conditions (moderate temperature, atmospheric pressure). Safety in storage and handling should also be considered. A storable liquid propellant should not have an excessively high vapour pressure at ambient temperature. The leading storable propellant uses dinitrogen tetroxide as oxidizer and a 50/50 mixture of hydrazine-unsymmetrical dimethylhydrazine (UDMH) as fuel [71]. Nitrogen tetroxide and UDMH is another storable propellant mixture in use [73].

Cryogenic liquids

They require a number of additional facilities such as a liquefying plant. The most common cryogenic propellant now in use is liquid oxygen-RP1 (rocket petroleum No. 1, a kerosene-cut hydrocarbon fuel). The higher energetic system liquid hydrogen-liquid oxygen is gradually being introduced.

Dole and Margolis [73] predicted that rocket propellants in use after 1961 would include:

Storable: perchloryl fluoride and hydrazine ($I_s=268$).

Cryogenic: liquid fluorine and hydrazine ($I_s=316$) or liquid oxygen and liquid hydrogen ($I_s=364$).

LITERATURE

1. SPRENGEL, Brit. Pat. 921, 2424, 2642 (1871); *J. Chem. Soc.* **26**, 796 (1873).
2. E. TURPIN, Fr. Pat. 146497 (1881); 147676 (1882); Ger. Pat. 26936 (1882).
3. K. OLSZEWSKI and S. WRÓBLEWSKI, *Wied. Ann.* [2], **20**, 243 (1883).
4. C. LINDE, Ger. Pat. 88824 (1895).
5. C. LINDE, *Sitzungsber. Münch. Akad. Wissenschaft.* **65** (1897).
6. H. KAST and P. GÜNTHER, *Z. ges. Schiess- u. Sprengstoffw.* **14**, 81 (1919).
7. P. PASCAL, *Explosifs, poudres, gaz de combat*, Hermann, Paris, 1925.
8. HELHOFF, Ger. Pat. 12122 (1880); 17822 (1881).
9. M. A. COOK, D. A. PACK and W. A. GAY, *VIIth Symposium on Combustion*, p. 702, Butterworth, London, 1958.
10. L. MÉDARD and R. SARTORIUS, *Mém. poudres* **32**, 179 (1950).
11. L. ANDRUSSOW, *Chimie et industrie* **86**, 542 (1961).
12. R. LEVY, *Chimie et industrie* **57**, 221 (1947).
13. R. B. CANRIGHT, *Ind. Eng. Chem.* **49**, 1345 (1957).
14. R. GROLLIER-BARON and G. WESSELS, *Mém. poudres* **36**, 285 (1954).
15. W. I. FEDOSYEV and G. B. SINYARYEV, *Vvedenye v raketnyu tekhniku*, Oborongiz, Moskva, 1956.
16. M. BARRÈRE and A. MOUTET, *Vth Symposium on Combustion*, p. 170, Reinhold, New York, 1955.
17. M. KILPATRICK and L. L. BAKER, JR., *Vth Symposium on Combustion*, p. 196, Reinhold, New York, 1955.
18. F. McCULLOUGH, JR. and H. P. JENKINS, JR., *Vth Symposium on Combustion*, p. 181, Reinhold, New York, 1955.

19. B. LEWIS, R. N. PEASE and H. S. TAYLOR, *Combustion Processes* (Vol. II of High-Speed Aerodynamics and Jet Propulsion), Princeton University Press, Princeton, N. Y., 1956.
20. D. ALTMAN and S. S. PENNER, *Combustion of Liquid Propellants*, Princeton University Press, Princeton, N. Y., 1956.
21. M. L. J. BERNARD, *Vth Symposium on Combustion*, p. 217, Reinhold, New York, 1955.
22. F. BELLINGER, H. FRIEDMAN, W. BAUER, J. EASTES and W. BULL, *Ind. Eng. Chem.* **40**, 1320 (1948).
23. C. W. TAIT, A. E. WHITTAKER and H. WILLIAMS, *J. Am. Rocket Soc.* **83** (1951).
24. W. S. WOOD, *Chemistry & Industry* **1959**, 136.
25. J. G. TSCHINKEL, *Ind. Eng. Chem.* **48**, 732 (1956).
26. J. A. HANNUM, U.S. Pat. 2537526, 2538516 (1951).
27. H. BEHRENS, *Z. Elektrochem.* **55**, 425 (1951).
28. R. SCHWOB, *Mém. poudres* **32**, 153 (1950).
29. N. S. DAVIS, JR. and J. H. KEEFE, JR., *Ind. Eng. Chem.* **48**, 745 (1956).
30. YA. M. PAUSHKIN, *Khimicheskii Sostav i Svoistva Reaktivnykh Topliv*, Akad. Nauk SSSR, Moskva, 1958.
31. E. S. SHANLEY and F. P. GREENSPAN, *Ind. Eng. Chem.* **39**, 1536 (1947).
32. W. LEY, *Rockets, Missiles and Space Travel*, Viking Press, New York, 1954.
33. e.g. B. E. BAKER and C. OUELLET, *Can. J. Research*, **23 B**, 167 (1945); P. A. GIGUÈRE, *Can. J. Research*, **25 B**, 135 (1947); R. G. MCKENZIE and M. RITCHIE, *Proc. Roy. Soc. (London)* **A 185**, 207 (1946); C. N. SATTERFIELD and T. W. STEIN, *Ind. Eng. Chem.* **49**, 1173 (1957).
34. R. R. BALDWIN and L. MAYOR, *VIIth Symposium on Combustion*, p. 8, Butterworth, London, 1958; *Trans. Faraday Soc.* **60**, 80, 103 (1960).
35. R. R. BALDWIN and D. BRATTAN, *VIIIth Symposium on Combustion*, p. 110, Williams & Wilkins, Baltimore, 1962.
36. P. A. GIGUÈRE and I. D. LIU, *Can. Chem. J.* **35**, 283 (1957).
37. W. FORST, *Can. Chem. J.* **36**, 1308 (1958).
38. D. E. HOARE, J. B. PROTHERO and A. D. WALSH, *Trans. Faraday Soc.* **55**, 548 (1959).
39. W. C. SCHUMB, C. N. SATTERFIELD and R. L. WENTWORTH, *Hydrogen Peroxide*, Reinhold, New York, 1956.
40. P. WALDEN and H. HILGERT, *Z. physik. Chem.* **165 A**, 241 (1933).
41. V. I. SEMISHIN, *Zh. obshch. khim.* **8**, 654 (1938).
42. V. C. BUSHNELL, A. M. HUGHES and E. C. GILBERT, *J. Am. Chem. Soc.* **59**, 2142 (1937); A. M. HUGHES, R. J. CARRUCCINI and E. C. GILBERT, *J. Am. Chem. Soc.* **61**, 2639 (1939).
43. W. A. ROTH, *Z. Elektrochem.* **50**, 111 (1944).
44. J. C. ELGIN and H. S. TAYLOR, *J. Am. Chem. Soc.* **51**, 2059 (1929).
45. P. J. ASKEY, *J. Am. Chem. Soc.* **52**, 970 (1930).
46. C. H. BAMFORD, *Trans. Faraday Soc.* **35**, 1239 (1939).
47. R. R. WENNER and A. O. BECKMANN, *J. Am. Chem. Soc.* **54**, 2787 (1932).
48. SCOTT, JONES and B. LEWIS, U.S. Bureau of Mines Report 4460, Washington, 1949.
49. M. RACIBORSKI, *Bull. Acad. Polon. Sci., Cracovie* **733** (1906); *J. Chem. Soc. (Abstracts)* **92**, 384 (1907).
50. L. F. AUDRIETH and B. S. OGG, *The Chemistry of Hydrazine*, J. Wiley, New York, 1951.
51. A. S. GORDON, *IIIrd Symposium on Combustion*, p. 493, Williams & Wilkins, Baltimore, 1948.
52. MCLARREN, *Automotive and Aviation Ind.* **95**, 20, 76 (1946).
53. F. A. WARREN, *Rocket Propellants*, Reinhold, New York, 1958.
54. G. M. PLATZ and C. K. HERSH, *Ind. Eng. Chem.* **48**, 742 (1956).
55. J. GLASSMAN and J. SCOTT, *Jet Propulsion* **24**, 386 (1954).
56. E. KRUSKA, *Z. VDI* **27**, 65, 271 (1955).
57. A. STETTbacher, *Explosivstoffe* **4**, 25 (1956).
58. *Fluorine Chemistry*, Ed. J. H. SIMONS, Academic Press, Vol. I, 1950; Vol. II, 1954.

59. A. ENGELBRECHT and H. ATZWANGER, *J. Inorg. Nuclear Chem.* **2**, 348 (1956).
60. R. L. JARRY, *J. Phys. Chem.* **61**, 498 (1957).
61. *Chemical Processing* **21**, 87 (1958).
62. M. A. ELLIOTT and F. W. BROWN, U.S. Bureau of Mines Report 4196, Washington, 1948.
63. P. A. JACQUET, *Metal Finishing* **47**, 62 (1949).
64. L. MÉDARD, P. A. JACQUET and R. SARTORIUS, *Rev. met.* **46**, 549 (1949); L. MÉDARD and R. SARTORIUS, *Mém. poudres* **32**, 179 (1950).
65. P. A. JACQUET, *Compt. rend.* **205**, 1232 (1937).
66. M. E. MERCHANT, *Metal Progress* **37**, 559 (1940).
67. E. KAHANE, *Compt. rend.* **227**, 841 (1948).
68. J. C. SCHUMACHER, *Perchlorates*, Reinhold, New York, 1960.
69. W. DIETZ, *Angew. Chem.* **52**, 616 (1939).
70. A. LATHAM, D. C. BOWERSOCK and B. M. BAILEY, *Chemical & Engineering News* **37**, No. 31, 60 (1959).
71. U. S. in Space, *Chemical & Engineering News* **41**, Sept. 23, 98; Sept. 30, 70 (1963).
72. J. F. TORMEY, *Ind. Eng. Chem.* **49**, 1339 (1957).
73. S. H. DOLE and M. A. MARGOLIS, in *The Chemistry of Propellants*, p. 1, Ed. S. S. PENNER and J. DUCARME, Pergamon Press, Oxford, 1960.

CHAPTER III
BLACKPOWDER

HISTORICAL

THE forerunner of all modern explosives, blackpowder, formerly often called gunpowder, is a mixture of potassium nitrate (saltpetre), sulphur and charcoal. The origin of blackpowder is obscure and dates back to very remote times. According to numerous historical works, in particular that of Romocki [1] blackpowder was invented by the Chinese many centuries B.C. The secret of its manufacture penetrated from there to Central Asia and was brought to Europe by the Arabs about the middle of the thirteenth century.

Combustible mixtures containing saltpetre, such as, for example, the famous Greek fire with which the Greeks destroyed the Arab fleet besieging Constantinople in 668, were already fairly widely known at that time. The secret of preparing Greek fire was supposed to have been brought to the Byzantine capital by Kallinikos, a Greek architect from Heliopolis of Syria. The Arab fleet was twice more defeated with this weapon in 716 and 718. The secret of Greek fire has never been disclosed in full but some medieval manuscripts reveal that it was a mixture containing constituents of blackpowder such as saltpetre and sulphur mixed with pitch. Obviously, this was not blackpowder but a mixture akin to it. The possibility that firearms were used for launching the incendiary missiles with a propellant charge can be ruled out since there is no doubt that catapults were used for throwing Greek fire.

Similarly, in a description of the siege of Niebla in Spain (1257) mention is made of the missiles thrown by the Moslems which produced a roar and flash. They were in all probability loaded with a mixture resembling blackpowder. At the battle of Legnica (1241) the Tartars employed another weapon, the so-called Chinese dragon belching fire; this was probably a type of a rocket-like launching device for incendiary missiles.

In the book by Marcus Graecus "*Liber ignium*" translated from Arab sources and published ca. 1300, there is a fairly full description of the composition of a combustible mixture called "flying fire" (*ignis volatilis*):

- 1 part of resin
- 1 part of sulphur
- 2 parts of saltpetre

The mixture was kneaded with linseed oil and loaded into a piece of hollow wood, and together these constituted an incendiary missile.

A description of the composition and principles of the manufacture of blackpowder appeared in the works of two of the greatest scientists of the Middle Ages: Albertus Magnus (Saint Albert the Great), a Dominican Monk born in Bavarian Swabia near 1200, and Roger Bacon of the Franciscan Order, born, according to tradition, about 1214 at Ilchester in Somerset, England.

Albertus Magnus gave a description of blackpowder in his manuscript "De Mirabilibus Mundi".

As early as 1249 Roger Bacon described blackpowder in his manuscripts "De Secretis" and "Opus Tertium" and gives its composition as follows:

41 parts of saltpetre
29.5 parts of charcoal
29.5 parts of sulphur

It was not until the invention of firearms that the manufacture and use of blackpowder really began to develop. This invention cannot be ascribed with certainty to any particular person, but recent historical research has shown that there is no foundation for the belief that Berthold Schwarz was the inventor. Arab manuscripts written as early as 1320 (e.g. the manuscript in the Leningrad Asiatic Museum by Shems ed Din Mohammed) show tubes employed for shooting balls by means of a charge of powder. It is also known that in 1326 the Republic of Venice ordered firearms and in 1331 cannons were used by the Moors during the siege of Alicante in Spain. Cannons were also employed on a wide scale both by the English and the French at the battle of Crécy in 1346. In Poland the first mention of the use of powder and firearms is to be found in the Statute of Wiślica promulgated by Casimir the Great in 1347 and afterwards, in the description of the battle of Grunwald in 1410, when the Poles employed over 60 guns. In Russia powder and firearms appeared during the reign of Duke Dymitr of Don, in the late fourteenth century. The first references appear in chronicles of 1382 and 1389.

In all probability the first "mills" for making powder in Europe were established at Augsburg (1340), Spandau (1344) and Legnica (1348).

The composition of the powder used in the fourteenth century was:

67 parts of saltpetre
16.5 parts of charcoal
16.5 parts of sulphur

A very detailed study of the history of Greek fire and blackpowder was published more recently by Partington [2]. The book, which is amply provided with full quotations from the original source is the most authoritative and extensive work on the subject.

Blackpowder was also used as a high explosive. According to Kochmyerzhvskii [3] blackpowder was first employed in civil engineering between 1548 and 1572 for cleaning and dredging the Niemen river-bed. In 1627, in Hungary, Kacper Weindl employed blackpowder in a mine for blasting hard coal.

The first published reference to the use of blackpowder in mining was the paper read to the Royal Society in London by Sir R. Moray in 1665 [4]. He referred to "a way to break easily and speedily the hardest rock". According to the same paper the method was invented by du Son in France.

J. Taylor [5] reports that in 1696 blackpowder was utilized to widen a road in Switzerland.

From that time the use of explosives for various engineering operations such as mining, road building, dam building, land improvement etc. became general.

According to Gorst [6] blackpowder is now employed for the following purposes:

- (1) as the filling for time-trains in time fuses,
- (2) in the manufacture of shrapnel shells to fire the charge that expels the bullets,
- (3) as a bursting charge in incendiary and star shells,
- (4) in the manufacture of delay pellets and boosters,
- (5) in the manufacture of powder pellets for primers,
- (6) in the manufacture of primers for igniting charges of smokeless powder and of pyrotechnic mixtures,
- (7) in the manufacture of safety fuses in which the cores consist of blackpowder.

In addition, blackpowder is also used (although the practice is decreasing) in sporting cartridges, in opencast coal mining and for blasting in mines where no methane occurs.

D. A. Davies [7] suggested the use of explosive charges for rain-making. The charges, consisting of 15 g of blackpowder plus 1.5% of silver iodide, are sent by balloon into a cloud, where they are exploded by a time fuse. The particles of silver iodide thus released act as nuclei on which the water vapour in a raincloud coagulates, to fall as rain drops.

Blackpowder containing silver iodide is obtained by saturating the blackpowder with an acetone solution of potassium silver iodide and then drying it. The required solution is prepared by dissolving 15 g of potassium iodide and 50 g of silver iodide in 200 g of acetone.

In Great Britain and throughout the Commonwealth blackpowder was used to prove alcohol. In this test alcohol was poured upon a small heap of blackpowder or "proof powder" and a light was applied to burn the heap. If the mixture burnt with explosion it was overproof, if it did not burn or burned with difficulty, the alcohol was underproof. If the mixture burned with "slight" explosion it was proof spirit, i.e. containing 49% alcohol by weight (Tate [8]).

COMPOSITION OF BLACKPOWDER

The blackpowder now most commonly used is composed of:

KNO ₃	75%
Charcoal	15%
Sulphur	10%

Charcoal

Charcoal here implies a component with variable properties, not a specific chemical. Hence depending on the method by which the charcoal is prepared powder with various properties could be obtained.

As early as 1848 this attracted the attention of Violette [9], who prepared different types of charcoal in a retort by employing different temperatures of carbonization (Table 75).

TABLE 75

EFFECT OF THE TEMPERATURE OF CARBONIZATION ON THE CHEMICAL COMPOSITION OF CHARCOAL

Temperature of carbonization °C	Colour of charcoal	Yield %	Composition of charcoal (%)		
			C	H	O+N
280-300	brown	34	73.2	4.3	21.9
350-400	black	28-31	77-81		
1000	black	18	82.0	2.3	14.1
1250	black	18	88.1	1.4	9.3

Violette found that the temperature of carbonization of wood is directly related to the ignition temperature of the charcoal obtained (Table 76).

TABLE 76

THE RELATION BETWEEN THE IGNITION TEMPERATURE OF CHARCOAL AND THE CARBONIZATION TEMPERATURE OF WOOD

Temperature of carbonization °C	Ignition temperature of charcoal °C
260-280	340-360
290-350	360-370
432	ca. 400
1000-1500	600-800

The ignition temperature of charcoal obviously influences the ignition temperature of the blackpowder. Blackpowder containing "cocoa-", red- or brown-coloured charcoal is most easily ignited, while the heat of combustion of black charcoal, more strongly carbonized, is higher than that of brown coloured material. Thus the power of powder containing black charcoal is greater.

Strongly carbonized (black) charcoal is less hygroscopic, hence the powder from which it is made is also less hygroscopic.

The temperature and ease of ignition of charcoal is influenced not only by the method of carbonization, but also by the type of wood used. A light, porous wood gives more easily ignitable charcoal.

In modern times, the influence of the type of charcoal on the burning of powder has been investigated by T. Urbański and Tešiorowski [10] and Blackwood and Bowden [11].

Much research has been devoted to the chemical structure of charcoal and has generally been concerned with comparing its chemical properties with those of coal in studying the latter's structure.

As early as in 1869 to classify various coals M. Berthelot [12] treated them with oxidizing agents such as nitric acid, potassium chlorate etc. and obtained a number of organic acids.

Next, Dickson and Easterfield [13] oxidized charcoal with fuming nitric acid in the presence of potassium chlorate and obtained mellitic acid in a yield of about 20% by weight. Finally, Dimroth and Kerkovius [14] made a very important observation: they converted the products of the oxidation of charcoal with nitric acid into barium salts and in turn subjected them to decarboxylation by distillation with barium hydroxide. In the products they detected the presence of benzene, naphthalene and fluorene. The presence of naphthalene and fluorene was the only direct evidence of the existence of condensed aromatic rings in charcoal. On the oxidation of charcoal with nitric acid in the presence of potassium hydrogen sulphate Meyer and Steiner [15] obtained pyromellitic acid. The presence of pyromellitic acid is considered to be indirect evidence of the existence of condensed aromatic rings in charcoal, which constitute an essential part of the chemical structure of charcoal. Nevertheless some authors questioned this view. Philippi *et al.* [16, 17] carried out experiments in which they treated charcoal with sulphuric acid at 300°C and obtained pyromellitic acid in a yield of 1–2%. Later they increased this yield to 6–7%, by conducting the reaction in the presence of mercury. They did not acknowledge this as evidence of the existence of strongly condensed aromatic rings since they had also prepared polycarboxylic aromatic acids by heating such aliphatic compounds as cellulose with sulphuric acid under similar conditions. This opinion, however, is hardly convincing since aromatic rings might have been formed on carbonization, in the course of the treatment with sulphuric acid.

In more recent times Juettner [18] has worked extensively on the oxidation of various types of coal, including charcoal. He examined the action of various oxidizing agents such as potassium permanganate in an alkaline medium and nitric acid. On such oxidation of the charcoal obtained by carbonization of cellulose at 1000°C mellitic acid in a yield of 25% by weight resulted.

Under similar conditions fluorene gives mellitic acid in a yield of about 45%, while hexaethylbenzene yields almost exclusively carbon dioxide, without mellitic acid. The experiments outlined above point to the existence of condensed aromatic rings in charcoal. This structure of charcoal has been definitely proved by infra-red

spectroscopic analysis carried out by T. Urbański, Hofman, Ostrowski and Witowski [19]. These authors investigated the infra-red absorption spectra of the products of thermal decomposition of cellulose and lignin at temperatures from 200–575°C. They showed that heating cellulose to a temperature above 300°C involves breakdown of the aliphatic structure of cellulose which is replaced by

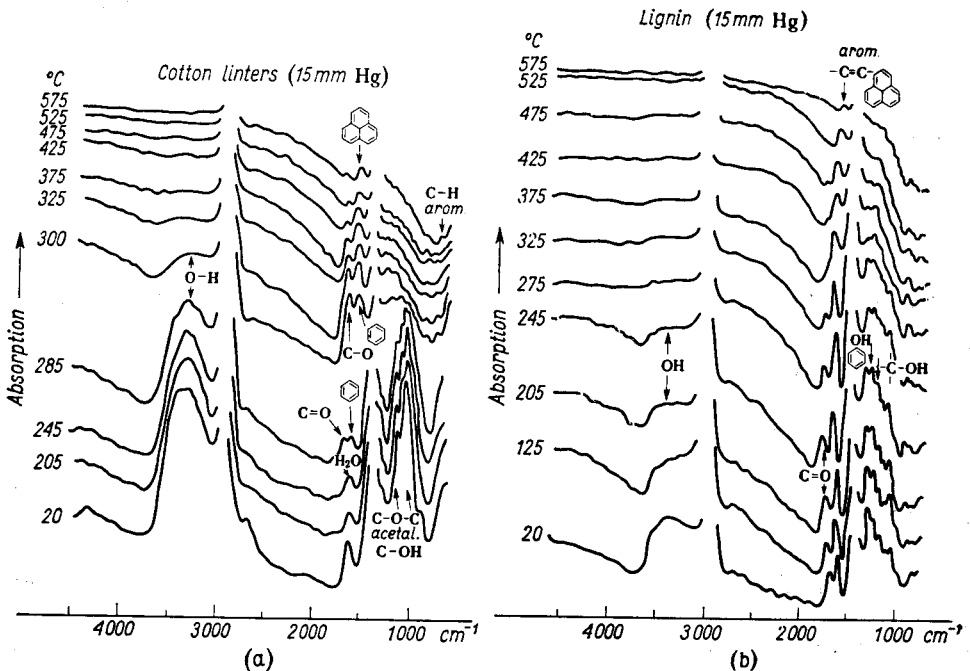

FIG. 86. Thermal decomposition of cellulose (a) and lignin (b) [19].

condensed aromatic rings. Thus the band 3300 cm⁻¹ of the alcoholic group (bound by a hydrogen bond) weakens with a rise in temperature and disappears at a temperature above 370°C. The band 1640 cm⁻¹ (derived from the water present in cellulose) weakens with a rise of temperature and disappears at a temperature above 245°C.

Cellulose shows the presence of a number of acetal bands (1155, 1105 and 1025 cm⁻¹) which disappear in test samples heated to higher temperatures (370°C or above). Similarly, a band characteristic of the bond C—O between carbon and hydroxyl group weakens with thermal decomposition and disappears at a temperature above 370°C.

In test samples heated to above 300°C there appear bands characteristic of the aromatic system, e.g. 1600–1570 cm⁻¹ (aromatic ring vibrations). Above 400°C the bands appear at 870 and 800 cm⁻¹, characteristic of C—H vibrations in condensed aromatic systems.

The changes in cellulose that occur on heating to various temperatures are shown in Fig. 86. The upper curves of cellulose carbonized at a high temperature (above 500°C) resemble closely those of anthracite or even graphite.

The graph showing the decomposition of lignin is similar, differing from cellulose in that here the change at a temperature of about 350°C is less pronounced since the lignin itself contains aromatic rings in its molecule. Above 350°C the bands characteristic of the aliphatic part of the lignin molecule fade, i.e. the frequencies of alcohol and phenol groups are 3300–3200 cm^{-1} , C—O of phenol 1265 cm^{-1} , C—O of alcohol and ether 1140, 1075 and 1030 cm^{-1} . Here also the general shape of the curves for most strongly carbonized material approximates to those characteristic of anthracite and graphite.

TYPES OF BLACKPOWDER

There are in fact two types of blackpowder classified according to their intended use:

- I—for filling fuses,
- II—for blasting charges.

With regard to chemical composition the difference between the two types is insignificant and lies mainly in their different rates of burning. In powders belonging to type II the rate of burning should be as high as possible. This is achieved by making the grains of powder of the density as low as possible.

The types of powder also differ in grain size. The powder used in small arms was manufactured in small grains, that for cannons being much larger. Sporting powder, for instance, (cf. Table 79) was manufactured in France in several grades differing in size of grain. Powder No. 0 consisted of the largest grains, powder No. 4 of the smallest, size being classified by the number of grains per gramme.

No. 0	650–950	grains per g
No. 1	2000–3000	grains per g
No. 2	4000–6000	grains per g
No. 3	8000–10,000	grains per g
No. 4	20,000–30,000	grains per g

Blasting powder consists either of grains with a density of about 1.8 or of compressed cylindrical pellets with a density of 1.35–1.50 and a central perforation. Blasting powder must burn vigorously so as to give an effect as close as possible to detonation. It is ignited either by a safety or detonating fuse. The explosive effect of the latter is stronger, and this may be enhanced by the “Herco blasting method” employed by Hercules Powder Co. [20], in which a detonating fuse inserted into the central perforation of the pellets acts as an initiating agent throughout the charge.

The composition of the powders used for mining purposes is given in Tables 77 and 78.

Mixtures with the addition of sodium nitrate (Table 78) are somewhat stronger giving more heat and a larger gas volume than those with potassium nitrate. They are more difficult to ignite and burn more slowly than mixture with potassium nitrate.

TABLE 77
COMPOSITION OF BLASTING POWDERS

Name	Composition (%)			
	KNO ₃	Sulphur	Charcoal	(NH ₄) ₂ SO ₄ and CuSO ₄
Strong blasting (French "poudre forte" in the form of globules or grains)	75	10	15	—
Slow blasting (French "poudre lente" in the form of globules or grains)	40	30	30	—
No. 1 blasting powder (Germany and Poland, 1924)	73-77	8-15	10-15	—
No. 1 Bobbinite with 2.5-3.5% paraffin (Great Britain)	62-65	1.5-2.5	17-19.5	13-17
No. 2 Bobbinite with 7-9% starch (Great Britain)	63-66	1.5-2.5	18.5-20.5	—

TABLE 78
COMPOSITION OF BLASTING POWDERS WITH SODIUM NITRATE

Name	Composition (%)			
	NaNO ₃	KNO ₃ (instead of NaNO ₃)	Sulphur	Charcoal
No. 1 black blasting powder (Germany and Poland, 1924)	70-75	up to 25	9-15	10-16
American blasting powder*	70-74	—	11-13	15-17
Petroclastite or Haloclastite, No. 3 black blasting powder	71-76	up to 5	9-11	15-19 of coal-tar pitch
No. 2 black blasting powder	70-75	up to 5	9-15	10-16 of lignite

* Blasting powders in the U.S.A. are marked according to the dimensions of graphitized grains: CCC (ca. 14 mm dia.), CC, C, F, FF, FFF, FFFF (1-2 mm dia.).

The mixtures recommended by Raschig [21] similar to those suggested earlier [22, 23] are also worthy of note. They consist of 65-70% sodium nitrate with 30-35% sodium benzenesulphonate or sodium cresolsulphonate, or xylenesulphonate etc. Mixtures of this type have long been used in mining, under the name of Raschit or White Powder. The inventor claimed that the advantage of such mixtures is their safety in manufacture. They were prepared by evaporating an aqueous solution of the ingredients to dryness. Similar mixtures according to the invention of Raschig

[24] were made at Pniowiec in Upper Silesia in 1912. They consisted of sodium or potassium nitrate (*ca.* 70%) and of sulphite liquor evaporated to dryness (*ca.* 30%).

Almost simultaneously Voigt [25] recommended using mixtures of nitrates (mainly sodium nitrate) with salts of nitrophenolsulphonic acids (e.g. mononitrophenol- and mononitroresolsulphonates) or salts of mononitronaphthalenesulphonic acid. He proposed mixing 25% of the aqueous solution with 75% of sodium nitrate.

TABLE 79
COMPOSITION OF POWDERS USED FOR MILITARY PURPOSES

Name	Composition (%)			Form and size of grains
	KNO ₃	Sulphur	Charcoal	
Cannon	75	12.5	12.5	7-21 mm
Sporting	78	10	12	0.1-1 mm
"Normal"*	75	10	15	various
Cannon modified	78	3	19	prisms (p. 360)
Delay fuse powder	75	10-12	13-15	grains 0.3-0.6 mm 4000-7000 per g

* Most commonly used for fire-arms e.g. as rifle powder.

The composition of blackpowder used in France for military purposes is given in Table 79. In many cases they have retained their traditional names in spite of altered application.

In the U.S.S.R. blackpowders for military purposes have a conventional composition: 75% KNO₃, 15% charcoal and 10% sulphur. Their grades differ in grain size. No. 1 cannon and rifle powder has large grains, No. 2 shrapnel of rifle powder has smaller ones, the finest being No. 3 rifle powder. In addition sulphurless powder composed of 80% KNO₃ and 20% charcoal is used in the U.S.S.R. as a priming composition.

Blackpowder for small rockets (chiefly sea rescue signal rockets) is characterized by its high content of charcoal.

It consists of:

	German rockets	American rockets
Potassium nitrate	60%	59%
Charcoal	25%	31%
Sulphur	15%	10%

MODIFIED BLACKPOWDER

Prior to the invention of smokeless powder various attempts had been made to improve blackpowder. In particular experiments were carried out: to obtain sulphurless powder, ammonium powder (with ammonium nitrate instead of potas-

sium nitrate), to replace potassium nitrate with potassium chlorate and, finally, to introduce a powder in which potassium or ammonium picrate was the combustible (and explosive) constituent instead of charcoal and sulphur.

Sulphurless powder

Andrew Noble [26] suggested the omission of sulphur in powder mixtures. He found a mixture of 80% KNO_3 and 20% charcoal to be somewhat stronger than blackpowder of normal composition, i.e. containing 10% sulphur. At Noble's suggestion sulphurless powder was introduced into England. This type of powder consisting of 80% KNO_3 and 20% charcoal is now used in Great Britain and the U.S.S.R. in igniters for firing pyrotechnic mixtures.

A stoichiometric mixture of potassium nitrate and charcoal contains 87.1% potassium nitrate and 12.9% charcoal. The decomposition is expressed theoretically by the following equation:



In this reaction 779 kcal/kg is evolved, the gas volume V_0 amounts to 240 l./kg, and the calculated temperature is 2700°C. For mixture consisting of 70% potassium nitrate and 30% charcoal (Sulphurless Gunpowder SFG.12) the heat of reaction is 670 ± 20 kcal/kg, according to Thomas [27].

Langhans [28] found that a mixture in which sulphur is replaced by selenium in no way resembles blackpowder. It is slow-burning and has no practical application.

Ammonium powder

Ammonium powder (formerly termed amide powder) was obtained in attempts to increase the power of blackpowder. One of the causes of the relatively low power of blackpowder lies in the fact that on explosion it produces a great quantity of solid matter, but only a relatively small volume of gas. In working for an increase of the volume of the gaseous products in the middle of the nineteenth century, attempts were made to substitute ammonium nitrate for potassium nitrate. The observation of Reiset and Millon [29] that a mixture of ammonium nitrate and charcoal has explosive properties and explodes on being heated to 170°C was the starting point for this work.

Gaens [30] obtained amide powder with the following composition:

KNO_3	40-45%
NH_4NO_3	35-38%
Charcoal	14-22%

This proved to be a more powerful explosive than blackpowder and burned with less smoke. Shortly afterwards it was used in Germany for small calibre naval guns.

Next, a similar powder was used for naval guns of larger calibre; this achieved great success as a greater muzzle velocity was obtained with a smaller charge of powder. Powder of this type was employed in Great Britain under the name of Chilworth Special Powder.

Ammonium powder obtained from ammonium nitrate and charcoal was also used successfully in guns of the Austrian navy between 1890–1896. It had however many disadvantages, since it was difficult to ignite, gave uneven results and was highly hygroscopic. This limited its use until it was withdrawn in all countries.

It was not until World War I that, due to the shortage of cellulose and acids for nitration, an ammonium powder with a composition of:

NH_4NO_3 85%
Charcoal 15%

was used for filling cartridges for Russian and German field artillery. In Russia it was termed SUD (Selitrougolnyi Dobavok) and in Germany Ammonpulver. The powder was manufactured in the form of rings with the outer diameter equal to the inner diameter of the cartridge case.

The main new feature introduced here was the use of combined charges i.e. of nitrocellulose and ammonium powder, the latter constituting 1/3 (exceptionally 1/2) of the whole charge. Here, nitrocellulose powder not only played the role of a propellant charge, but also acted partly as a secondary primer regulating the burning of the ammonium powder. The greatest disadvantage of ammonium powder, viz. the difficulty of ignition and burning, was thus overcome. It also turned out that ammonium powder possesses the advantages of being only slightly erosive and producing only slight muzzle flash. The hygroscopicity of ammonium powder was overcome by employing a special packaging with hermetically sealed cartridge cases.

Ammonium powder has the important disadvantage that ammonium nitrate occurs in various crystallographic forms with different specific gravities, one of the transitions taking place at +32°C, i.e. only just above room or summer temperature (Vol. II). When a charge of ammonium powder is heated to this temperature a decrease in density occurs and in consequence there is an undesirable increase in rate of burning.

During World War I 3000 tons of ammonium powder was produced monthly in Germany.

Towards 1934 a number of patents were filed on mixtures approximating in composition to ammonium powder and containing ammonium nitrate and guanidine nitrate or nitroguanidine with the addition of ammonium bichromate. In many cases gelatinized nitrocellulose was added as a binding agent. Compressed charges of these mixtures had a low rate of burning and a low calorific value. They could be applied to small jet engines, e.g. in World War II they were recommended for torpedo propulsion and for driving certain engines and various mechanical devices. These will be dealt with in later sections.

As a result of this work general conclusions were made as to the value and significance of certain constituents.

It was established that the addition of kaolin to mixtures containing ammonium nitrate raises the level of pressure at which burning is stabilized and facilitates uniform burning of the mixtures.

The presence of guanidine nitrate proved to be preferable to that of nitroguanidine since the former permits the charges to be compressed to a great density.

2,4-Dinitroresorcinol proved to be an important constituent of these mixtures as an sensitizing agent i.e. facilitating uniform burning under low pressure.

Asbestos, which increases the burning surface of powder mixtures, is also added and a small amount of vanadium pentoxide which exerts an advantageous influence on the uniformity of burning of a mixture.

By 1949, pressed charges began to come into use for a variety of purposes such as operating reciprocating engines, turbostarters for aircraft, starter motors for Diesel engines, etc. For example, a typical solid gas-generating charge for the "Williams and James" motor, designed for starting bus engines, was made from compressed pellets: 10 g of guanidine nitrate plus 15% 2,4-dinitroresorcinol, with a burning time of approximately 1 sec [5].

A similar mixture was used for starting the turbo starters of Armstrong-Siddeley Sapphire turbojet engines. The charge weighed 5 lb and burned one-sidedly from the central hole. The burning time was 10 sec, and the pressure developed was 750 lb/in².

A mixture of similar composition in the form of pellets weighing 12 g each and burning "cigar" fashion was introduced in 1949-1950 to start up 2 gallon fire extinguishers manufactured by General Fire Appliance Company. The burning time of the charge was 1 min. A charge weighing 1.3 lb and burning for 3 min was also designed for a 34 gallon extinguisher [5].

A different type of ammonium powder containing ammonium bichromate was also used to activate the "Williams and James" reciprocating engine.

This was composed of:

NH ₄ NO ₃	78.5%
KNO ₃	9.0%
Ammonium oxalate (anhydrous)	6.9%
Ammonium bichromate	5.6%
China clay	0.7%

The 15 lb charge was pressed in increments, under a pressure of 5550 lb/in² (370 kg/cm²) into an internally-insulated steel tube so that it formed a continuous solid column. The charge was ignited by means of an electric powder fuse comprising a small charge of ca. 0.32 g (5 grains) of blackpowder. The gases drove the engine for 3 min 20 sec. The operating gas pressure rose to 280 lb/in².

For larger engines a charge of 149 lb was pressed at 12,000 lb/in² into a container 17 in. dia. The gases drove the engine for 2 min at an average pressure of 530 lb/in².

The same composition was used for driving a rotary blower motor. For this purpose an 8 lb charge was pressed into a 3.5 in. internal diameter steel tube lined with insulating material.

Another charge used for engine-starting had the composition:

Nitroguanidine	56.0%
Guanidine nitrate	28.0%
Ammonium chromate	8.0%
Dimethyl diphenyl urea	4.0%
Beech charcoal	4.0%

8 lb of this powder, pressed under a pressure of 6000 lb/in² (400 kg/cm²), gave a charge that ran the "Williams and James" engine for 3 min 20 sec at a pressure rising slowly from 100 to 190 lb/in². The gas temperature leaving the charge tube was 600°C and at the engine inlet 340°C.

Another composition was:

Guanidine nitrate	94.5%
Vanadium pentoxide	0.5%
Cuprous oxide	5.0%

This charge was ignited by *ca.* 0.32 g (5 grains) of blackpowder igniter and a nitrocellulose-red lead oxide-silicon mixture.

For more information see J. Taylor [5].

A quasi-powder consisting of ammonium nitrate, guanidine nitrate and nitroguanidine with an admixture of potassium or ammonium chromate was employed as an agent for dispersing pesticides. This mixture burns slowly evolving a relatively small amount of heat. When mixed with a pesticide in equal proportions, the smoke formed on burning is rich in the pesticidal substance. Gammexane (BHC) DDT, Parathion, azobenzene etc. may be dispersed in this way (Marke and Lilly [31]).

Recently, mixtures containing ammonium nitrate have been recommended as materials for rocket propulsion (p. 383).

Chlorate powder

The first attempts to substitute potassium chlorate for potassium nitrate undertaken by Berthollet [32], who discovered potassium chlorate, were unsuccessful. It was immediately evident that a mixture of potassium chlorate, sulphur and charcoal was exceptionally sensitive to impact and friction, and was therefore too dangerous to manufacture. The removal of sulphur from the mixture did not increase safety and thus the powder has never found practical application.

Picrate powder

In 1861 Designolle [33] suggested using potassium nitrate mixed with metal picrates, mainly potassium picrate, as a propellant substitute for ordinary black-

powder. It was manufactured on a rather large scale in Le Bouchet in France and used during the Franco-Prussian War of 1870-71.

Blackpowder and small arms powder contained 9-16% and *ca.* 23% potassium picrate, respectively.

In 1869 Brugère [34] and independently F. Abel [35] suggested the use of ammonium picrate in a mixture with potassium nitrate instead of blackpowder.

By employing virtually the same procedure as in the manufacture of blackpowder grains were obtained and then slightly polished. When examined in France in 1881 this powder gave good results for use with rifles and cannon, considerably surpassing blackpowder in strength. Brugère powder (Poudre Brugère) consisted of:

Ammonium nitrate 43%

Potassium nitrate 57%

The new propellant was promising but the nitrocellulose smokeless powder invented soon afterwards superseded all mixtures containing potassium nitrate and similar salts, that give a number of solid particles when exploded. For a time in the United States various mixtures were still used instead of blackpowder—chiefly for sporting purposes. E.g. Gold Dust Powder (Starke [36]) consisted of 55% ammonium picrate, 25% potassium picrate and 20% ammonium bichromate. Soon, however, early in the nineteenth century, the use of these mixtures was discontinued.

In World War II a variety of picrate powder consisting of ammonium picrate, potassium or sodium nitrate and a binding agent was introduced in Great Britain and in the U.S.A. as the propellant charge for small rockets. This was reported more fully in a chapter devoted to mixtures for rocket propulsion (p. 365).

THEORY OF THE BURNING OF BLACKPOWDER

For a long time attempts have been made to explain why three non-explosive substances, viz. potassium nitrate, charcoal and sulphur, when combined together should form an explosive mixture. It was particularly incomprehensible that binary mixtures of potassium nitrate with charcoal or with sulphur should be non-explosive or only poorly so. The problem was the more difficult to elucidate since it involves a reaction in the solid phase.

A number of outstanding scientists such as Descartes (1644) [37], Newton (1705), Lomonosov (1750) endeavoured to explain the course of the reaction that occurs when blackpowder burns. Both these and later investigators tried to analyse the explosion products of blackpowder and to derive equations for the decomposition process.

Gay-Lussac [38] found that the gases were composed of 52.6% CO₂, 5% CO and 42.4% N₂, their volume, when the density of the powder was 0.9, being 450 times the volume of the explosive. Piobert [39] disagreed with these results, finding a much lower value for the gas volume which he asserted was 250 times the volume of the charge.

Chevreuil [40] reported that in the bore of a gun barrel the powder decomposes according to the equation:

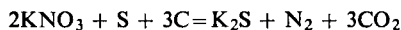

If the powder burns in the open potassium sulphide is oxidized to sulphate. When blackpowder burns slowly the products, apart from carbon, include such components as potassium sulphide, sulphate, carbonate, cyanide, nitrate and nitrite.

A classical paper on the composition of the explosion products of blackpowder and of the heat of reaction was published by Bunsen and Shishkov [41]. They ascertained that the gases formed constitute 31% of the charge and contain approximately 50% CO_2 , 40% N_2 , 4% CO and lesser amounts (0.5–1.5%) of H_2 , O_2 , H_2S . Solid products consist of potassium carbonate, sulphate, thiosulphate, sulphide and nitrate with traces of potassium rhodanate, sulphur and carbon. These authors also detected the presence of ammonium carbonate.

These investigations were repeated by Linck [42], Karolyi [43] and Fiodorov [44]. Fiodorov's works are original in character: he examined the composition of the solid products of the explosion of blackpowder in a pistol or gun barrel, and arrived at the conclusion that the composition of these products depends on the conditions of firing, for instance on the calibre of the gun or pistol. He also established that the primary solid products of explosion consist of potassium sulphate and carbonate, which then undergo reduction under the influence of the excess carbon.

Extensive work on the products of the explosion of blackpowder in a confined space were carried out by Andrew Noble and F. Abel [45]. They showed that there is considerable variability in the composition of the products, depending on the conditions under which the powder explodes.

On the basis of Bunsen and Shishkov's investigations, Berthelot [46] derived the following equation for the decomposition of the powder:



A further advance was the development of the first theory about the explosion of blackpowder by Berthelot, who for this purpose drew largely on the experimental work described above.

Berthelot assumed two limiting cases for the decomposition of powder:

(1) With the formation of K_2CO_3 as a chief product of decomposition and of K_2SO_4 as a by-product;

(2) With the formation of K_2SO_4 as a chief product of decomposition and of K_2CO_3 as a by-product.

In the first case the decomposition proceeds according to the following three equations:

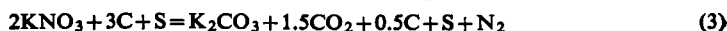
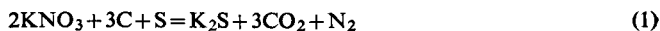

so that $\frac{1}{3}$ of the powder decomposes according to equation (1), a half according to equation (2) and the rest ($\frac{1}{6}$) according to equation (3).

In the second case the decomposition runs according to the four equations, namely (1), (3), (4) and (5) so that $\frac{1}{3}$ of the powder decomposes according to equation (1), a half according to equation (3), $\frac{1}{8}$ according to equation (4) and the rest ($\frac{1}{24}$) according to equation (5).

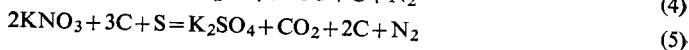
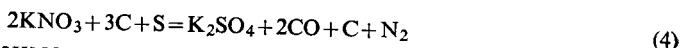

Debus [47] came to the conclusion that the burning of blackpowder is a two-stage process. In the first oxidation occurs according to the exothermic reaction:

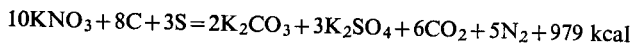

The products so formed are then reduced according to the following endothermic reactions:

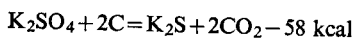

Potassium sulphide so formed may undergo further reactions, viz.:

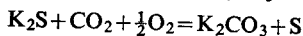
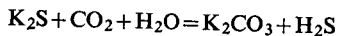

A part of the unburnt potassium sulphide and sulphur gives K_2S_2 .

Much later K. A. Hoffmann [48] resumed work on the mechanism of explosion of blackpowder. On examining the behaviour of mixtures of charcoal with sulphur he found that the reaction in blackpowder starts above the melting point of sulphur, at approximately 150°C , with a reaction between hydrogen present in charcoal and sulphur. Hydrogen sulphide thus formed reacts at temperatures between 285 – 290°C with potassium nitrate to yield K_2SO_4 . Heat is then emitted which causes the KNO_3 to melt. This is an essential moment in the overall reaction since molten saltpetre reacts with molten sulphur and with carbon. The reaction proceeds the more readily the lower the melting point of the saltpetre, so that a powder with the addition of NaNO_3 (m.p. 313°C) ignites and burns more readily than a mixture with KNO_3 alone (m.p. 340°C). Blackpowder containing a mixture of potassium nitrate with sodium nitrate ignites still more readily since a eutectic mixture of KNO_3 and NaNO_3 melts at a temperature of about 220°C .

To prove the soundness of his theory Hoffmann refers to the fact that blackpowder is relatively difficult to ignite (as compared with nitrocellulose, for instance), not taking fire even from a strong electric spark but only on being heated to the temperature at which the above described reactions begin to take place.

Hoffmann also performed many experiments on the significance of sulphur in blackpowder mixtures (this problem was previously raised by Andrew Noble [49]) to substantiate his statement that blackpowder is well fitted for use when composed only of potassium nitrate and charcoal, hence without sulphur or with a smaller

content of sulphur, e.g. 2%. From these experiments he drew the following conclusions:

(1) Sulphur facilitates an increase in the quantity of gases evolved on explosion. In the absence of sulphur potassium nitrate with carbon gives only K_2CO_3 , but in the presence of sulphur CO_2 is evolved and potassium forms K_2SO_4 and K_2S .

(2) Sulphur reduces the initial decomposition temperature. For instance a mixture of two moles of KNO_3 and three gramme-atoms of carbon (in the form of 71% charcoal) begins to decompose at $320^\circ C$ and explodes at $357^\circ C$, while a mixture of two moles of KNO_3 and one gramme-atom of sulphur begins to decompose at $310^\circ C$ and explodes at $450^\circ C$. Finally, a mixture of two moles of KNO_3 , one gramme-atom of sulphur and three gramme-atoms of carbon begins to decompose at $290^\circ C$ and explodes at $311^\circ C$.

(3) Sulphur intensifies the sensitiveness of mixtures to impact; a mixture of KNO_3 and charcoal does not explode while a mixture of KNO_3 and sulphur decomposes when struck by a 2 kg weight falling from 45–50 cm. On the other hand, a mixture of KNO_3 , charcoal and sulphur is exploded by a 2 kg weight from a drop of 70–85 cm

(4) Sulphur counteracts the formation of carbon monoxide in the products of explosion. CO and KCN occur in the products of decomposition of a mixture of KNO_3 with charcoal, due to the reaction of charcoal with K_2CO_3 :

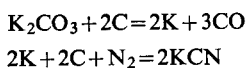

On the other hand, in the presence of sulphur a reaction with K_2SO_4 takes place:

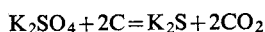

As there is no CO in these products no hydrogen evolves since the following reaction does not take place:

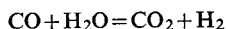

When there is little sulphur in the powder, toxic CO is formed so that in black-powder for mining purposes the content of sulphur should be not less than 10%.

Reactions between potassium nitrate and charcoal have also been investigated by Oza and Shah [50].

Blackwood and Bowden [11] have more recently published extensive studies on the mechanism of the initiation and burning of blackpowder and on that of the reactions of binary mixtures, viz. KNO_3 + sulphur; sulphur + charcoal; KNO_3 + charcoal.

It may be concluded from their experiments that burning occurs in a place heated to a temperature of $130^\circ C$ or higher. Heat may be applied either by the direct effect of flame or by a hot metallic surface (e.g. glowing wire); heating may also result from impact, adiabatic compression of the air in the spaces between the grains of powder and finally, by mutual friction between the grains. The temper-

ature of 130°C is considerably lower than the usual ignition temperature, nevertheless it may be sufficient to provoke an explosion if the grains are confined.

When the grains of blackpowder are subjected to a pressure of about 150 atm explosive decomposition may start at a temperature considerably lower than usual.

The propagation of flame from grain to grain is caused by an emission of hot molten potassium salts projected from one grain to another as the powder burns.

The ease of ignition of blackpowder and its rate of burning are influenced by the type of charcoal used, the decisive agents in this respect being in the opinion of Blackwood and Bowden those constituents of charcoal which can be extracted with organic solvents. Depending on the content of these constituents in the charcoal the properties of the blackpowder can be varied, i.e. the smaller the content of soluble constituents in the charcoal, the easier is the ignition and the faster the rate of burning of the powder.

Blackwood and Bowden formulate the following mechanism for the ignition and burning reactions of blackpowder. First sulphur reacts with organic substances present in charcoal:



Almost simultaneously saltpetre reacts with these compounds:

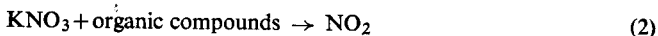

The following reactions may also occur:

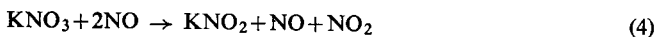
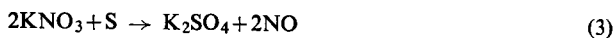

Reaction (5) proceeds until all the hydrogen sulphide is used up when NO_2 appears and begins to react with the still unconsumed sulphur according to equation (6):



The sulphur dioxide so formed may immediately react with potassium nitrate:

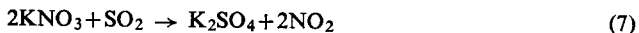

Reactions (5) and (6) are endothermic, but reaction (7) is strongly exothermic. Reactions (1)–(7) constitute the ignition process. According to Blackwood and Bowden the chief reaction when the powder begins to burn is the oxidation of charcoal by potassium nitrate.

EXPLOSIVE PROPERTIES OF BLACKPOWDER

From a comprehensive analysis of the products of explosion of blackpowder Kast [51] derived the following equation:

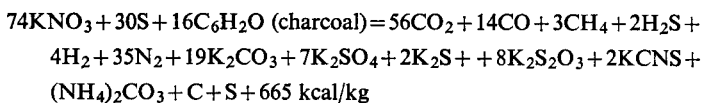

The heat of explosion and gas volume naturally depend on the composition of the powder. Noble and Abel [45] in the work quoted above give the following figures (Table 80):

TABLE 80

DEPENDENCE OF THE PROPERTIES OF BLACKPOWDER UPON THE COMPOSITION

Blackpowder	Composition			Heat of explosion kcal/kg	Gas volume V_0 cm ³ /g
	KNO ₃	Sulphur	Charcoal		
Coarse-grained	75	10	15	726	274
Fine-grained (sporting)	75	10	15	764	241
Blasting	62	16	22	516	360
"Cocoa" powder	80	2	18	837	198

The latest studies of H. Thomas [27] quote the following figures for "Normal Gunpowder G.12":

Potassium nitrate	75.3%
Charcoal	14.4%
Sulphur	10.3%

Heat of explosion is 735 ± 15 kcal/kg at a moisture content of 0.85%. In dry powder heat of explosion is 740 ± 15 kcal/kg.

According to Kast, the gas volume V_0 is 280 l./kg, the specific pressure f is 2800 m and the temperature of explosion t is 2380°C (Noble and Abel found this value to be 2100–2200°C, Will [52]—2770°C).

The specific gravity of blackpowder may vary within the limits of 1.50–1.80 depending on its intended use. Its apparent density is 0.900–0.980.

Blackpowder is highly sensitive to impact and friction. It explodes when struck by a 2 kg weight falling from 70–100 cm. Its ignition temperature is 300°C. A sack filled with blackpowder takes fire when penetrated by a rifle shot.

The rate of burning of blackpowder at atmospheric pressure is much greater, than that of smokeless powder, but the rate and mode of burning at a pressure higher than atmospheric depend on its compression pressure. Grains of blackpowder do not burn by parallel layers but all over the mass of charge, if their density is lower than 1.75. Above this density they burn by parallel layers and the burning time then depends on the grain size (Vieille [53]). E.g. blackpowder with a density of

1.8 shows a rate of burning of about 10 cm/sec at a pressure of 1660 kg/cm² while nitrocellulose or nitroglycerine smokeless powder has a rate of burning of 15–30 cm per sec.

According to Blackwood and Bowden [11] a single grain of blackpowder burns with a rate of 0.4 cm/sec at atmospheric pressure. The flame is propagated along the line of grains at a rate of 60 cm/sec at atmospheric pressure.

Blackpowder for demolition charges or as a mining explosive has a lower density (about 1.67) and therefore burns very fast while blackpowder with a higher density

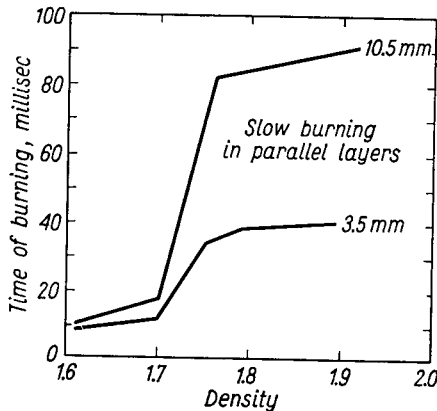

FIG. 87. The relation between the time of burning of blackpowder and its density (for grains 3.5–10.5 mm dia.).

(about 1.87), used as a propellant, burns slowly in parallel layers (Fig. 87). It is very important for the blackpowder to be of adequate density since this makes it possible to control its burning rate. The pressures required for obtaining charges of suitable density are listed below (according to Rinckenbach and Snelling [54]).

Pressure kg/cm ²	Density
200	1.32
330	1.41
660	1.55
1330	1.695
2000	1.775
3330	1.84
5000	1.88
6660	1.88

Blackpowder may explode violently if it is confined in an air-tight container and initiated with a strong initiator. Its lead block expansion scarcely amounts to 30 cm³ due to the “non-hermetic” effect of sand stemming. In an iron tube 35–41 mm dia. it gives a rate of explosion of 400 m/sec.

Andreyev [55] has made extensive studies on the transition of the burning of blackpowder into explosion. He used for this purpose a device composed of an iron tube, 40 mm in inner diameter and 200 mm in length, containing a 50 g charge of blackpowder and hermetically sealed. When the charge is ignited, if the blackpowder undergoes deflagration only, it ejects the steel base of the tube, whereas if the deflagration passes into explosion, the tube is blown into several pieces.

According to Andreyev blackpowder may burn at a pressure lower than atmospheric. Burning, however, is the more difficult, the lower the surrounding pressure. The limiting pressure at which blackpowder still burns is 0.1 kg/cm². From 2–30 atm the dependence of the rate of burning on the pressure may be expressed by the equation $U = 72p^{0.24}$, where U is a linear rate of burning in cm/min and p the pressure in atmospheres.

THE MANUFACTURE OF BLACKPOWDER

RAW MATERIALS

Saltpetre

Potassium nitrate is obtainable from natural deposits in hot countries e.g. Ceylon, Egypt, Mexico, India, Iran and some areas of the U.S.S.R. It occurs there as the result of the microbiological oxidation of organic nitro compounds and of the reaction of the products with the alkaline components of the soil. On being refined by crystallization such saltpetre was (and partly still is) used for the manufacture of blackpowder. In Great Britain for instance until relatively recently the only source of potassium nitrate was saltpetre from India.

At one time potassium saltpetre was also obtained from manure and wood ash. Here potassium nitrate forms as a result of microbiological processes followed by reaction with potassium carbonate. Descriptions from various periods of history may also be found that refer to the collection of saltpetre from the walls of cellars situated in the vicinity of sewers. In this way, for instance, saltpetre was acquired in Poland for the manufacture of blackpowder during the insurrections of 1830 and 1863.

From the middle of the nineteenth century potassium nitrate began to be manufactured from Chilian saltpetre containing 20–35% NaNO₃. The Chilian saltpetre was first refined to increase the content of NaNO₃ to 95% and afterwards subjected to the exchange reaction:



Reaction (1) is conducted in an aqueous solution at a temperature of 100°C. It takes the desired course due to the poor solubility of NaCl at this temperature. The sodium chloride is then precipitated and the reaction therefore shifts to the right. The potassium nitrate so obtained was termed "converted saltpetre".

Another method of manufacturing KNO_3 was based on double decomposition with potassium carbonate.

At present, reaction (1) is most frequently used to obtain potassium nitrate although the sodium nitrate used is now of synthetic origin.

Another method now employed consists in the treatment of potassium carbonate or caustic potash with nitrogen dioxide. The course of the reaction is:

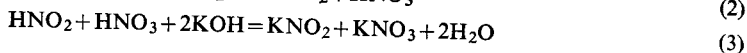
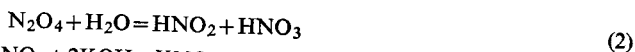

A mixture of potassium nitrite and potassium nitrate is treated with nitric acid to oxidize nitrite to nitrate:

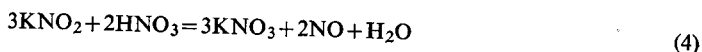

Still another method for the preparation of KNO_3 directly from KCl and nitric acid was used recently. Reaction proceeds at temperatures between $75\text{--}85^\circ\text{C}$ according to the approximate equation:

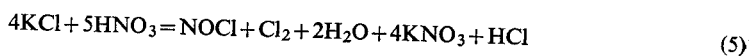

Potassium saltpetre prepared by any of these methods is refined i.e. it is recrystallized from water by a method chosen in accordance with the impurities known to exist in the product.

Crystallization is facilitated by the great difference in solubility of potassium nitrate at high and low temperatures (it is ten times more soluble at 100°C than at 10°C).

Potassium saltpetre for the manufacture of blackpowder must be of high purity. The technical specification for the synthetic product according to the U.S.S.R. standard (GOST 1939-43) is summarized in Table 81.

TABLE 81

TECHNICAL SPECIFICATION FOR SYNTHETIC KNO_3 USED IN THE MANUFACTURE OF BLACKPOWDER (GOST 1939-43)

Requirements	Class	
	I	II
Appearance	white crystals	white crystals
Min. content of KNO_3 , %	99.8	99.0
Max. content of moisture, %	0.1	0.2
Max. content of chlorides, calculated as NaCl , %	0.03	0.1
Max. content of carbonates, calculated as K_2CO_3 , %	0.03	0.5
Max. content of water-insoluble substances, %	0.04	0.04
Max. content of substances insoluble in hydrochloric acid, %	0.005	0.02

Potassium saltpetre manufactured from Chilian saltpetre may also contain potassium perchlorate and potassium iodate, which are very detrimental since they

increase the sensitiveness of blackpowder to friction and impact. A great many explosions which have occurred during the manufacture of blackpowder have been ascribed to the presence of these salts in saltpetre, although it has not been ascertained experimentally that small admixtures of KClO_4 increase the sensitiveness of blackpowder to impact and friction. Nevertheless, for the sake of safety potassium nitrate manufactured from Chilian saltpetre must not contain perchlorates and iodates in analytically detectable quantities.

Chilian saltpetre

Some types of blackpowder used for blasting contain sodium instead of potassium saltpetre. Such a mixture is sometimes termed "explosive saltpetre" and is considered a cheap substitute for blackpowder. The advantage of Chilian saltpetre as an oxidizing agent lies in the fact that by weight it contains more oxygen than potassium saltpetre. Its disadvantage consists in its relatively high hygroscopicity, although this is caused by the presence of calcium salt since chemically pure sodium nitrate is only slightly hygroscopic.

According to Soviet Standards GOST 828-41 sodium saltpetre for the manufacture of blackpowder mixtures should contain not less than 98% NaNO_3 and less than 2% moisture.

Sulphur

For the manufacture of blackpowder the sulphur used should be of highest purity, refined by distillation. Crude sulphur (which usually contains 2-5% of impurities) is distilled from retorts heated to a temperature of 400°C . The receiver should be maintained at a temperature above 115°C (120 - 130°C), i.e. above the melting point of sulphur (114 - 115°C). Under these conditions the distillate condenses to a liquid which is then cast into sticks or blocks. This is the only form of sulphur suitable for the manufacture of blackpowder. If the receiver temperature is lower, the sulphur distilled from the retort condenses as flowers of sulphur which always contain a little SO_2 , and even traces of H_2SO_4 (the substance is easily oxidized due to its large surface area). Sulphur in this form is therefore slightly hygroscopic and acidic, and is unsuitable for the manufacture of blackpowder.

Charcoal

It is very important to select a suitable type of wood for the manufacture of the charcoal used in blackpowder. It must be soft, but not resinous and should be prepared from "white wood" of such trees as alder, poplar, willow, hazel etc. Before carbonization the wood must be de-barked and cut into pieces 10-30 mm thick. In some countries where hemp is plentiful the stems of this plant are used for making charcoal.

The material to be carbonized is placed into sheet-iron retorts, approximately 1 m dia. and 1.5–3 m long, one end of which is closed with an air-tight lid and the other fitted with an offtake for the gaseous products of distillation. These products are usually burnt since it is not worth while recovering them. The combustion of CO is particularly important, otherwise it may poison the atmosphere. The retorts are heated either by exhaust gases or by superheated steam. Carbonization lasts for 3–8 hr depending on the construction of the furnace and retorts, the temperature, and the type of material to be carbonized. After carbonization the retorts are taken out of the furnace and allowed to cool down (with the offtake closed). The charcoal is removed from the retort when it is cool—hot charcoal easily ignites. The charcoal should not be milled until the fourth day after its removal from the retort since charcoal which is too fresh may catch fire during milling.

Three types of charcoal are obtained depending on the temperature of carbonization (Table 82).

TABLE 82
TYPES OF CHARCOAL

Type	Temperature of carbonization °C	Content of C %
"Cocoa" (red)	140–175	52–54
Brown	280–350	70–75
Black	350–450	80–85

In some blackpowder type mixtures, especially those for mining purposes, charcoal is partially or wholly replaced by carbon black, brown coal, pitch from coal tar, coal tar itself, naphthalene, paraffin, wood bark, cellulose or wood meal, starch, resin etc. Thus mixtures are obtained with properties similar to blackpowder. Generally, however, they burn more slowly and are more difficult to ignite.

MILLING THE INGREDIENTS

The manufacture of blackpowder consists in thoroughly mixing the well-milled ingredients to obtain the required particle size and density. (Fast-burning blackpowder is fine-grained while the slower-burning type has larger grains of high density.) Manufacture consists of the following operations:

- (1) Milling of the ingredients;
- (2) Mixing of the ingredients;
- (3) Pressing;
- (4) Corning and finishing (drying, polishing and screening).

The methods of manufacture depend upon the trend of development traditional in a given factory or country. The variety of methods arises partly from the fact that the manufacture of blackpowder is highly dangerous so that different countries

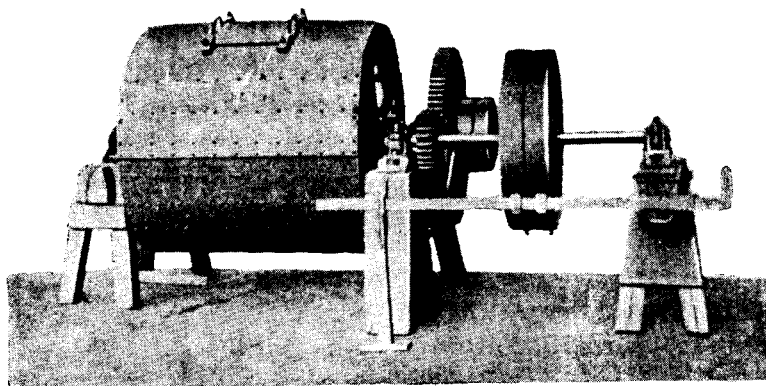

FIG. 88. Iron ball mill.

have worked out their own methods of reducing risks. Nevertheless, there are certain agreed methods observed everywhere.

The ingredients of blackpowder may be milled by two methods:

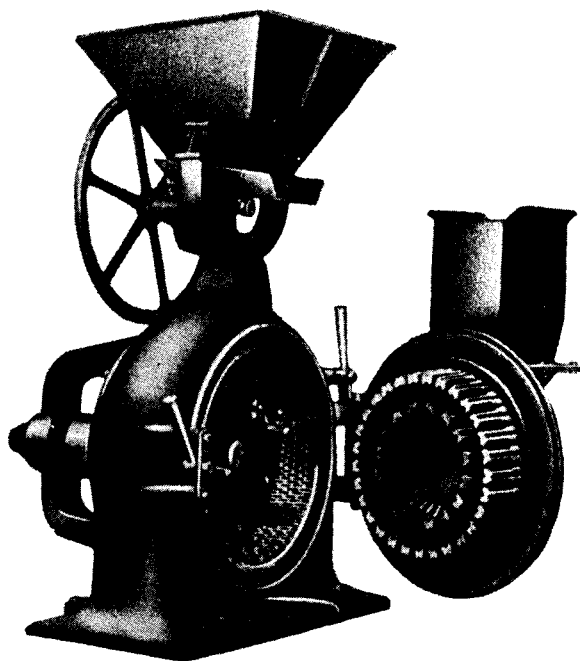

FIG. 89. Disk mill.

- (1) Each ingredient may be milled separately;
- (2) Two ingredients may be milled together: charcoal with sulphur and charcoal with saltpetre.

Saltpetre (dried at temperatures ranging from 100–110°C if necessary) is milled either in ball mills, using iron balls (Fig. 88), in disk mills (Fig. 89), or in disintegrators.

Charcoal is usually milled in either ball mills or disintegrators. It may be given a preliminary treatment in edge runners.

Sulphur is milled in similar equipment, but in some countries edge runners or rollers are used. Since sulphur is strongly electrified on milling it is advisable to add

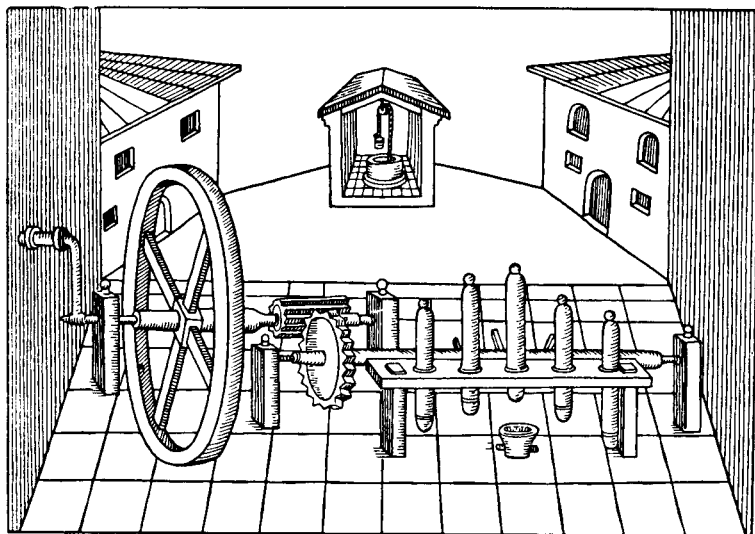

FIG. 90. A sixteenth-century stamp mill (the stamps and one of the mortars are shown).

to it a slight amount of saltpetre to increase its electrical conductivity and reduce the danger of an explosion of sulphur dust suspended in air. Until 1881 such dust explosions were frequent. For the same reason all the equipment used for milling, especially for milling charcoal and sulphur, should be well earthed.

Up to the end of the eighteenth century the ingredients of blackpowder were milled in stone or wooden mortars in which the wooden pestles were fitted with power drive (Fig. 90). The production capacity of such devices was, of course, rather low. They were used too, for mixing the mass of powder, but this proved to be dangerous, and in several countries (e.g. Great Britain) it was prohibited by law (about 1772).

In some countries (France and Switzerland) it is believed that it is more dangerous to mill charcoal and sulphur separately than together in the correct proportions. Saltpetre is also milled together with charcoal since the addition of such a mixture to a mixture of charcoal and sulphur is supposed to be safer than the addition of saltpetre alone if the ratio of charcoal to saltpetre in the mixture added does not exceed 1:15.

Thus in France binary (two-component mixtures called "binaires") are formed:

Binary mixture containing sulphur (sulphur with charcoal);

Binary mixture containing saltpetre (saltpetre with charcoal).

Binary mixtures of charcoal with sulphur or with saltpetre, being insensitive to friction and impact, are prepared in iron ball mills composed of drums (1.2 m dia. and 1.5 m in length) with bronze balls. The drums (Fig. 91) are fitted inside with

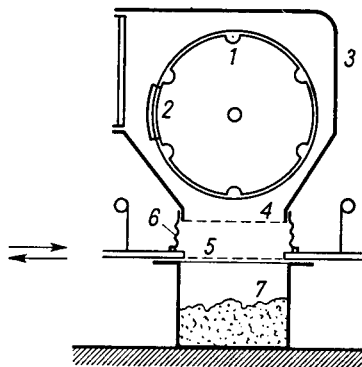

FIG. 91. Iron drum for preliminary milling of the ingredients of blackpowder in the form of two-component mixtures.

humps (1) which increase mixing and milling efficiency of the bronze balls. The drums are fitted on their cylindrical surface with a door (2) for loading and unloading. To prevent escape of dust into the premises they are enclosed in a tin casing (3), with a funnel for unloading on its lower end. The mouth of the funnel is closed by a coarse stationary screen (4) and, situated below this, there is a fine vibrating screen (5) with a clearance of 0.65 mm. Screen (5) is connected with the mouth of the funnel by a leather sleeve (6).

The drum charge ranges from 80 to 180 kg:

Binary mixture containing sulphur: sulphur 50 kg
charcoal 35 kg

Binary mixture containing saltpetre: saltpetre 155 kg
charcoal 10 kg

In addition 100–150 kg of bronze balls 8–15 mm dia. are loaded into the drum, which rotates with a rate of 18–20 r.p.m.

The binary mixtures are mixed and milled for 4–6 hr, after which the drum is stopped, the door is opened and the contents are poured out by slow rotation. The balls are retained by screen (4) while the material sifted through screen (5) falls into the tin container (7) which can be hermetically sealed.

Separate drums should be used for the preparation of these binary mixtures. Special care must be taken to ensure that the container for the sulphur mixture is properly sealed, otherwise the sulphur which has been finely milled and heated on milling may oxidize and even ignite in contact with air.

In the German factories at Spandau, Hanau, Ingolstadt and Gnaschwitz, milled saltpetre, milled charcoal and a mixture of equal amounts of sulphur and saltpetre were prepared in separate operations.

MIXING THE INGREDIENTS

The mixing of the three ingredients is one of the most dangerous operations in the manufacture of blackpowder. If mealed powder is to be produced for pyrotechnic purposes (e.g. for signal or rescue rockets), or for initiators, mixing in a drum is sufficient. For the manufacture of granulated or pelleted powder, the ingredients must be mixed in an edge runner, though sometimes drums with wooden balls may be employed.

Mixing in a drum

When mixing the three ingredients to obtain mealed powder, wooden drums 1.5–1.7 m dia. are used in a drum, provided with wooden humps. The humps enable the drums to be rotated with a speed of 17–19 r.p.m.; without them the speed would

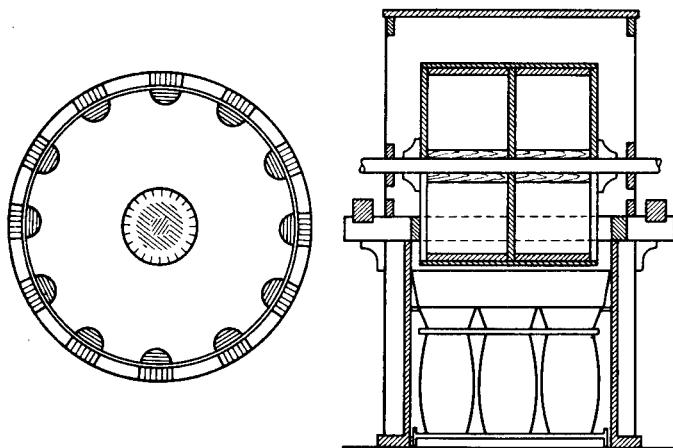

FIG. 92. Wooden drum for mixing three ingredients of blackpowder.

have to be increased to 25–26 r.p.m. On completion of the mixing process the lid is taken off the outlet, which is covered with the screen, the contents are turned out by slowly rotating the drum, and sifted through the screen. Such a mixture is ready for use in pyrotechnics. In some factories drum mixing is carried out as a preliminary to kneading in edge runners.

In some factories the three ingredients are dampened with 8–10% of water and then mixed in wooden drums with wooden balls (Fig. 92). The balls work by a kneading action so that to some extent they replace mixing in an edge runner. The

required quantity of water is introduced into the drum by a special pipe. After being removed from the drum, the damp mass is pressed into cakes in the same way as the product from the edge runners.

Mixing in an edge runner

The edge runner (Figs. 93 and 94) consist of two heavy (500–600 kg) cast-iron wheels approximately 1.5 m dia. and 0.5 m wide. The wheels rotate around horizontal shafts connected by a clutch with a vertical axle (1) so as to enable clutch (2) to be lowered or raised together with the suspended wheels (3). The vertical axle butts against the bearing (4) situated in the centre of an iron tray (5). Near the wheels

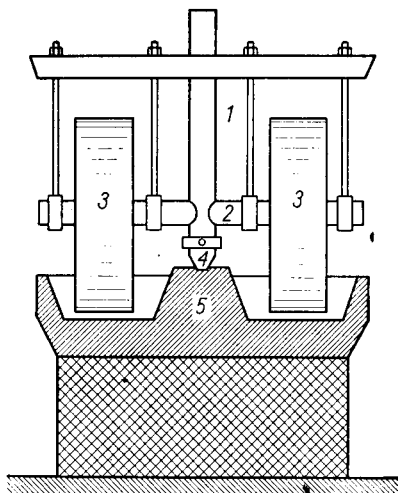

FIG. 93. Diagram of an edge runner.

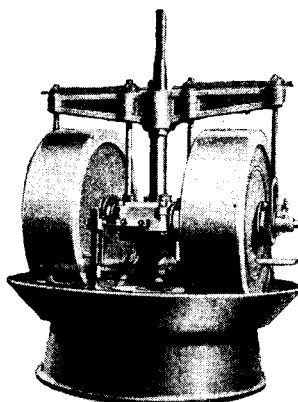

FIG. 94. General view of an edge runner.

and along the vertical axle there are bronze scrapers which push the mixture under the wheels (the scrapers near the wheels push the material towards the centre of the tray, those along the vertical axle push it away from the centre of the tray). The material is thus continuously raked under the rolling wheels. The level at which the scrapers are fixed can be regulated. The wheels may rotate about the vertical axle at two speeds: a high speed of 10–15 r.p.m. and a low one of $\frac{1}{4}$ – $\frac{1}{2}$ r.p.m. As a safety precaution, all the nuts and other parts which might be loosened by the continuous motion are split-pinned or fastened with copper wire to prevent them from falling into the mass of blackpowder and thus causing an explosion. To prevent electrification of the charge the equipment must be well earthed.

Near the vertical axle of the edge runner there is a tube for supplying the charge with the necessary amount of water. In modern factories the water storage tank and the cock regulating the water inflow are situated in an adjacent room from which the apparatus is operated.

During mixing, the gap between the surface of the wheels and the tray must not be less than 4 mm, so as to avoid the danger of seizing. This gap is regulated according to the size of the charge and the density of mixture required. The greater the required density the less should be the gap: the pressure of the wheels on the mixture is then higher.

This principle of mixing by means of suspended wheels was not introduced until the end of the nineteenth century; before then the kneading process in edge runners was the most dangerous operation in the manufacture of blackpowder. Wooden

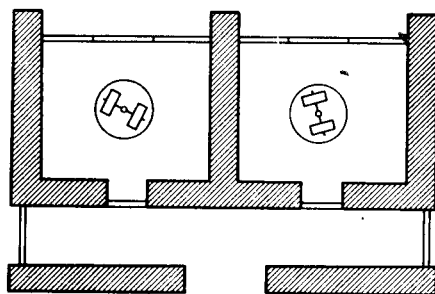

FIG. 95. Lay-out of a building in which edge runners operate.

trays were introduced in some factories to increase safety, but they wore out too quickly. In many factories the use of edge runners, which caused such frequent explosions, was completely abandoned in favour of drum mixing and the edge runners have only been re-introduced in very few instances.

A lay-out of a factory building in which edge runners are operated is shown in Fig. 95. The building has a "blow-out" construction, i.e. the three walls are stout and the fourth together with the roof is light-weight with a door. One edge runner is placed in each compartment. There is also an engine room in which the engines and transmission gear are mounted (the edge runners usually have an overhead drive comprising bevel gearwheels). There is a window in the wall protected by thick panes, through which a worker operating the edge runner can watch the run of the machine. Switches regulating the run of the edge runner and the cock which controls the water inflow are within arms reach. Admittance to the room where the edge runners operate is prohibited except for the loading and unloading of material. Special felt-soled slippers, left standing by the door, should then be put on to prevent sand from being carried in from outside. When the edge runner is operating at high speed there is no admittance whatever into the premises.

Mixing proceeds in the following way: The ingredients, milled separately or in binary form, are weighed out into wooden boxes or barrels fitted with grips, and following the addition of *ca.* 8% of water (10% on hot and dry summer days) they are mixed by hand with a wooden paddle. The damp material is spread evenly over the tray of the runner. The layer of the material should not be less than 1 cm thick.

The wheels are then set in motion, the rotational speed of the vertical axle being increased gradually so that rolling is carried out with an angular-translatory motion.

Thus the wheels knead, grind and mix the material and at the same time press it by their dead weight.

Due to friction the temperature rises to 30°C, and water evaporates so that further addition should be made from time to time i.e. whenever the mass begins to form dust, which indicates a drop in water content to 2-4%.

If the wheels cease to rotate about their axle, friction develops between the surface of the wheels and the mixture which, apart from lowering the efficiency of the runner, may lead to the ignition of the mixture (e.g. after the surface has dried). To prevent this the runner is adjusted to run at slow speed (which is quite safe) and leather is inserted between the wheels and the kneaded mixture. With the pressure of the wheels on the thickened layer the friction increases and the wheels begin to rotate. The leather may then be removed and the runner switched over to high-speed motion.

The runners are costly to operate since they consume much energy. Care should be taken therefore that they work for as short as possible a time. The maximum density of material is obtained after 1-1.5 hr; further kneading reduces the density of the mixture until a limit is reached.

Escalles [56] gives the following figures characterizing the influence of duration of kneading on the density of the product (according to data obtained from the powder factory at Spandau).

Duration of kneading	Density
1 hr 48 min	1.63
2 hr 40 min	1.42
5 hr 24 min	1.36
7 hr 12 min	1.36

The French data, however, are somewhat different (Pascal [57]), namely:

Duration of kneading	Density
Mining powder 30 min	1.57
Military powder F ₃ 2-2.5 hr	1.47
Sporting powder (78% saltpetre) 1.5 hr	1.725
Sporting powder (78% saltpetre) 5 hr	1.80

If the dust sifted during the later operations is re-used for kneading, the process may be shortened since the material is already partly kneaded. Kneading is carried out with a moisture content of 2-4%.

PRESSING

After the kneading has been completed the mass is pressed to form press cakes which are then dried. These cakes are hard and give a conchoidal fracture. Pressing is done either: (a) in the same edge runners; (b) in hydraulic presses.

Pressing in edge runners

Pressing in edge runners as carried out in France is effected by lifting the scrapers after mixing has been completed, with the runner in slow-speed motion. The wheels knead the mass which is not now raked by the scrapers. The material thus obtained is in the form of a hard press cake which is then air-dried at temperatures from 20 to 30°C.

Pressing in hydraulic presses

The damp mass of powder removed from the edge runners is spread in an even layer up to 9 cm thick over bronze or copper plates. Several layers are thus superimposed and compressed in a press (Fig. 96) at a pressure from 25 to 35 kg/cm² for

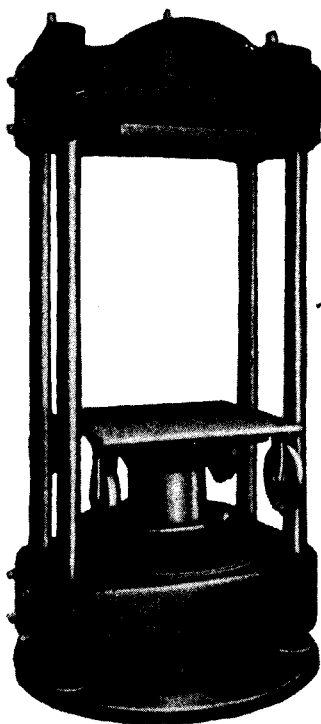

FIG. 96. Blackpowder press, hydraulically operated.

30–40 min. At this pressure the density of the grains obtained amounts to 1.7. By applying a pressure of 100–110 kg/cm² for 1.5–2 hr a density of 1.8 may be achieved. The valves of the press must be handled at a safe distance, from behind a strongly built protective wall, since pressing entails some danger e.g. a slight sliding movement, under the effect of high pressure, may cause an explosion. After pressing, the press cakes are dried, as described above.

CORNING

Corning is accomplished by breaking up the press cakes into grains, usually in roll corning mills. Drum corning mills are also used but less frequently. For some types of quick-burning powders combined corning is applied using grains from the corning mill together with meal powder (granulation).

Roll corning mill

The dried press cakes are broken up with a mallet into smaller lumps and thrown continuously into the corning mill (Figs. 97 and 98) consisting of several pairs of bronze rollers arranged one above the other. After being crushed between the up-

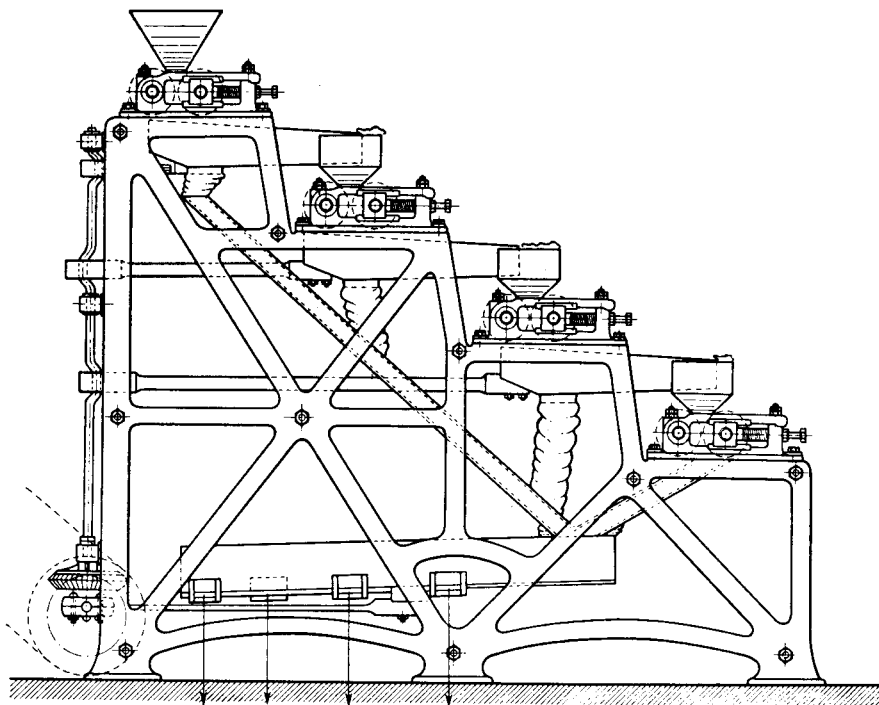

FIG. 97. Corning mill for granulating blackpowder.

per pair of rollers the material passes over an automatic sieve, which separates out the dust. The coarse pieces are crushed by the next pair of rollers, that operate at slower speed, so as to form smaller grains. This process of sieving and crushing is repeated in the following series of rollers and sieves until the material from the last pair of rollers produces grains of the desired size. Any grains that are still too large are recycled.

The brass sieves under the rollers are stretched on frames so that they can be easily taken out and, if necessary, replaced by sieves of different mesh size. The sieves and rollers are enclosed in a plywood casing, to prevent the escape of dust. Sometimes dust absorbers are fitted (Fig. 98).

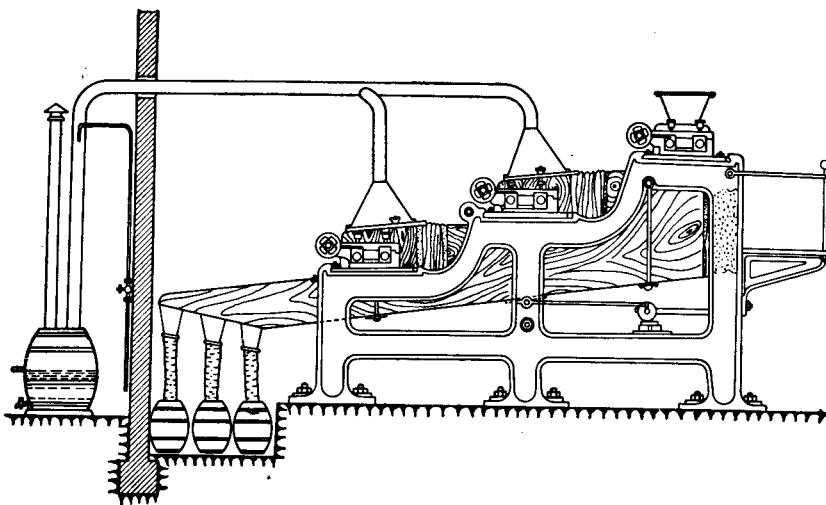

FIG. 98. Corning mill with dust remover.

Since the corning process may be dangerous, the mill is never approached while the machinery is in operation. In modern factories loading is performed by placing the feed pipe of the charging hopper over the corning mill in a separate cage, shielded by a ferro-concrete barrier. Corning mills should be well earthed. The danger is particularly great if foreign bodies e.g. metal fragments or nails, are caught between the crushing rollers. The presence of such objects in the corning mill has caused a number of explosions.

Drum corning mill

The drum corning mill (Fig. 99) comprises two concentric drums (1) and (2), 1.15 and 1.25 m dia. made of brass net stretched on a wooden frame with wooden ribs inside. The inner drum (1) is made of 7.5 mm mesh net while the outer drum (2) is of smaller mesh corresponding to the required grain size. The drums are located in a casing (3) made of plywood. The casing is connected with the vibrating screens (5) by a leather sleeve (4). The mesh sizes for different grain sizes (denoted by number of grains per gramme) are:

Sizes of screen meshes (mm)		Number of grains per gramme
I	II	
1.6	1.2	650-950
1.2	0.8	2000-3000
Silk muslin		20,000-30,000

The press cakes, broken into pieces with a mallet, are loaded continuously through a hole in the drum near the axle. As the drum rotates the particles are broken down until grains of the right size are obtained. They are then separated by sieving.

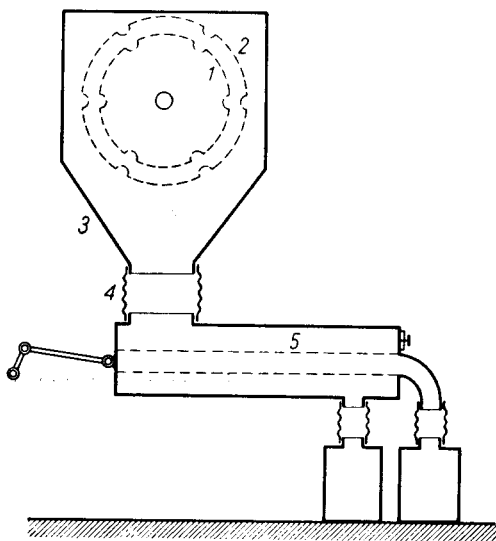

FIG. 99. Diagram of drum granulation.

Granulating in drums. In some countries (e.g. France) the manufacture of very fast-burning low density blackpowder for use in mining is carried out by granulating moistened mealed powder. In the granulating process, a wooden drum 1.6 m dia. and 0.6 m long is employed. A definite number of powder grains are taken from the corning mill, and moistened to a 10% water content with mealed powder produced by mixing of the three ingredients. They are then poured into the drum. As the drum rotates the mealed powder sticks to the surface of the grains to form spherical granules. External wooden hammers are used to prevent the mass from sticking to the inner surface of the drum. The mass heats up by friction and part of the water evaporates, hardening the grains. The granulated powder is sieved to obtain grains in the size range 3–6 mm. The undersized grains are recycled and the oversized ones are ground in the corning mill and granulated again.

FINISHING

The powder from the corning mill is then finished. This consists mainly of polishing, drying and grading the grains. If cylinders are required (blasting powder of the German type) finishing is limited to pressing the grains into cylinders.

Polishing, drying and grading

After corning the grains have an irregular and rough surface which prevents them from flowing freely and from filling a space without voids, so that their density is rather low. To overcome this, the powder grains are polished and thus acquire a smooth, slippery surface. The powder from a corning mill subjected to polishing contains *ca.* 1.5–3% (according to German data) or 4% (according to French data)

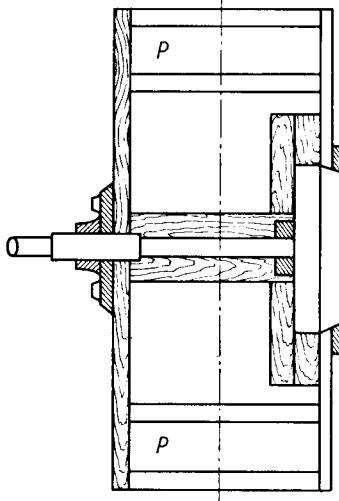

FIG. 100. A leather drum for polishing (the latter is stretched on a wooden frame).
P indicates the wooden ribs.

of moisture. The tumbling drums are constructed similarly to that shown in Fig. 92. They may be made of leather stretched on a wooden frame (Fig. 100). The rate of rotation of the drum, dependent on its dimensions, is 7–16 r.p.m. (smaller drums rotate more quickly to reach the peripheral velocity required). The drum can be charged with 100–240 kg of powder.

At first, the work is carried out with the side door closed so that the powder retains enough moisture to facilitate the polishing process. After a few hours 0.1–0.5% of graphite is added to the charge and polishing is continued for several more hours. The graphite fills the pores in the surface of the grains and coats them with a thin layer, giving them their characteristic brightness.

During the last hours of polishing the side door in the drum is opened so that some of the moisture escapes. The overall polishing process lasts for 4–24 hr, depending on the type of powder. The finished grains are more slippery, pour more easily and fill space better than the unpolished product.

The fine-grained powder used for filling time-trains in time fuses is sometimes polished by coating the grains with a layer of shellac. For this an alcoholic solution of shellac (1–2% shellac by weight) is sprayed into the drum. Powder grains coated with this material burn more slowly than usual. The rate of burning can be regulated by the amount of shellac used.

The polished powder is dried at 50°C to 0.5–1.0% moisture content (in countries with a damp climate the permissible moisture content is higher and in countries with a dry climate—lower). Shelf driers with a natural stream of warm air are usually employed. The use of a pressurized air stream is permissible provided that it is

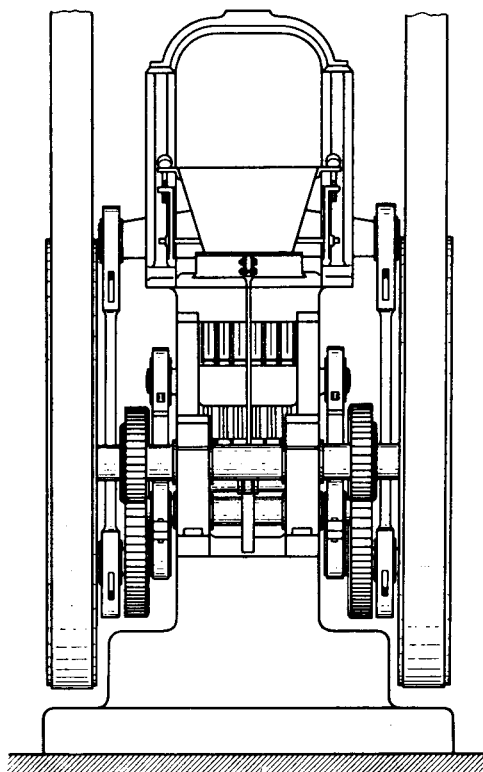

FIG. 101. A multistroke press of the Vyshnegradskii type.

warmed. The use of suction fans is inadvisable since dust from the powder may penetrate their mechanisms and ignite.

The polished, dried powder is finally graded by sieving out the dust. Revolving or various types of vibrating sieves, often hand driven for safety (see Fig. 99) are used for this purpose.

The sieve frames should be made of wood to avoid the danger of friction and impact. Brass mesh (formerly perforated parchment) or silk muslin is used, stretched on frames so that the sieves can be easily arranged according to the grain sizes required. Dust separated out by sieving is sent back to the edge runners.

After all these operations, i.e. corning, polishing, drying and grading, have been completed 50 kg of the powder, ready for use, is obtained from 100 kg of mixture supplied to the edge runner. All the waste material accumulated during processing is returned to the edge runners. The yield is higher in the manufacture of coarse-grained powder than in that of fine-grained powder.

Final pressing

Final pressing is applied to blasting powder of the German type which is obtained in the form of cylindrical pellets 30 mm dia. and *ca.* 40 mm long with a central hole 10 mm dia. along the axis of the charge. The hole serves for the insertion of a detonating cup or a detonating fuse (p. 328).

Unpolished or polished powder grains containing moisture (up to 4%) are pressed for a short period (e.g. 30 min) in a mechanical press using two pistons: one

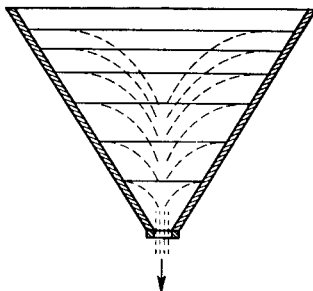

FIG. 102. Diagram showing the working principle of a funnel in powder blending.

applied from above, the other from below in order to achieve a highly uniform density. Vyshnegradskii [58] designed this technique. The press is usually a multi-stroke unit in which six to twelve pellets are compressed at the same time (Fig. 101).

The compressed pellets are finally dried at 50°C to increase their resistance to mechanical shock. On drying, the moisture content falls below 1%. Blackpowder in the form of cylindrical pellets is the most suitable type of explosive for blasting. Cannon blackpowder was also once produced in the form of prisms; (this will be discussed later, in the chapter on cannon blackpowder).

BLENDING

To obtain a uniform lot of granular powder several batches are blended in a wooden funnel. The powder is poured into the funnel in layers after which the bottom outlet of the latter is opened. As the contents pour out, like liquid, they are blended (Fig. 102).

CANNON POWDER

Blackpowder for the manufacture of propellant charges has long been obsolete although some types are still produced for other purposes. Thus the French "cube" powder, poudre C or poudre SP, is employed as an igniter in bag cartridges.

Cannon powder is manufactured by kneading in an edge runner followed by pressing the cake to a high density. Afterwards the mass is corned, moistened to 3–3.5% water content and pressed again into cakes at a pressure of 100 kg/cm².

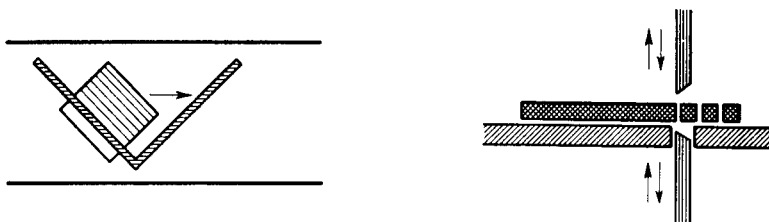

FIG. 103. Cubing sheets of blackpowder.

The sheets are then sliced on a cutter (first into strips, then into cubes) using a rectangular blade (Fig. 103).

After a short polishing period to smooth over and round off the sharp and irregular edges, the cubes are separated from dust and dried to the less than 1% water content.

At one time prismatic powder with a very high density, burning in approximately parallel layers, acquired an importance, but now it is only of historical interest.

It was invented in the United States by Rodman [59] and improved during the period 1868–1882. It had the form of a hexagonal prism (Fig. 104) with a central

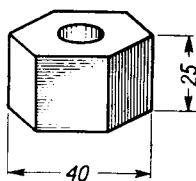

FIG. 104. Blackpowder in prism form.

channel and was manufactured in the usual way with the distinction that the grains from the corning mill were finally compressed into prisms by the Vyshnegradskii hydraulic press (p. 358). It was used for long-range gun fire. Since powder for this purpose must burn as slowly as possible the following measures were taken to reduce the rate of burning:

(1) Brown charcoal was used in the mixture.

(2) The sulphur content in the mixture was reduced. This gave the following compositions:

	In Germany and France	In Russia	In Belgium
KNO ₃	78%	75.5%	52%
Sulphur	3%	8.5%	9%
Charcoal	19%	16%	39%

(3) Powder cakes (before corning) were pressed in a hydraulic press to a density of 1.80 and after separating 2.5 mm grains, were pressed again into prisms with a density of 1.86.

(4) The prisms were dried as slowly as possible (3–7 days) and at a low temperature (35–40°C) to avoid the formation of internal fissures due to over-rapid drying.

Mention should also be made of another method of reducing the rate of burning of the powder, i.e. the addition of paraffin. In some French cube powders, paraffin was substituted for 5% of charcoal.

SAFETY IN BLACKPOWDER FACTORIES

The manufacture of blackpowder is one of the most dangerous in the production of explosives.

The individual operations are carried out in "danger buildings", separated by safety distances. These distances are reduced if the buildings are mounded. For unmounded buildings the average safety distance is 50 m. A blow-out construction

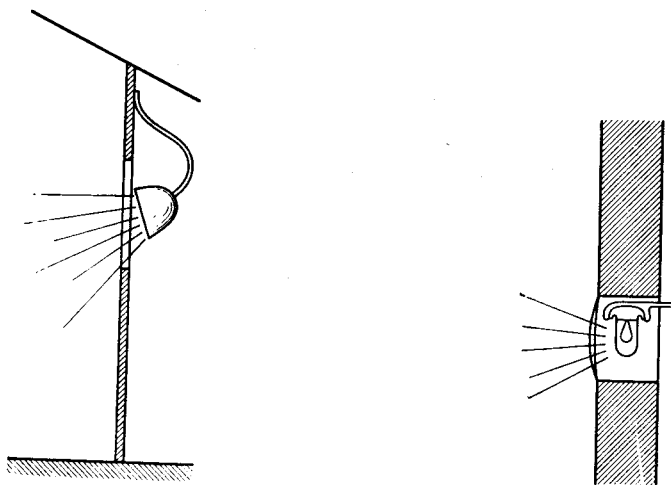

FIG. 105. System for illuminating buildings in which blackpowder is manufactured.

is usual: three walls are of stout brick while the fourth wall and the roof are of light-weight construction, e.g. of wood or asbestos tile. Alternatively, the whole building may be constructed of light-weight boards.

Shelters for the workers should be set up in the vicinity of each building. These are huts covered with earth at the side of the operating building. If the buildings have three stout walls the shelter may be located behind one of them. Doors and windows should be large to give plenty of light, and closed from outside with a wooden

shutter. Except for windows facing north the glass should be opaque or coloured. Doors and windows are fitted with overhanging eaves to protect the interior of the building from rain. Inside the building, the floor may be either of wood (all crevices being sealed with pitch) or of asphalt or concrete, close-covered with linoleum. It is also desirable that a wooden barrier should be erected at the entrance forming an anteroom in which those who enter the danger building put on clean felt overboots.

Electric cables should be carried in steel conduits on the exterior of the walls. Incandescent lamps inside the building should be recessed into the walls and pro-



FIG. 106. Remote control of a machine dangerous to operate (corning mill) in a blackpowder factory [60].

ected by safety glass. Alternatively, the buildings may be lit through the windows by reflector lamps (Fig. 105). The buildings may be heated only by hot water (not by steam) and the radiators must be dusted frequently.

All machines must be well earthed, all their frictional parts being made of bronze, wood etc. If steel parts must be used they should be lubricated profusely, if possible, with solid grease (vaseline, cup grease). Particularly dangerous machines (e.g. corning mills) must be operated by remote control (Fig. 106).

In front of the building a timber floor protected by a eave should be laid. Trucks coming and going with materials should be moved by hand. Trucks with pneumatic-tired wheels or barrows with bronze wheels are best for this purpose. If a narrow-gauged track is to be used, in the vicinity of buildings holding blackpowder, the rails should be of wood and the trucks should be fitted with bronze wheels.

Blackpowder must be packaged for transport in cloth or rubber bags and placed in tightly closed wooden boxes.

LITERATURE

1. S. J. ROMOCKI, *Geschichte der Explosivstoffe*, Oppenheim, Berlin, 1895-1896.
2. J. R. PARTINGTON, *A History of Greek Fire and Gunpowder*, Hoffer & Sons, Cambridge, 1960.
3. W. KOCHMYERZHEVSKII, *Podrywnoye delo*, St. Petersburg, 1898, according to PAPROTSKII, *Bolshaya Sov. Entsiklopediya*, II ed., 7, 1951.
4. Sir R. MORAY, *Phil. Trans.* No. 5, 82 (1665).
5. J. TAYLOR, *Solid Propellants and Exothermic Compositions*, Newnes, London, 1959.
6. A. G. GORST, *Porokha i vzryvchatyye veshchestva*, Oborongiz, Moskva, 1949.
7. D. A. DAVIES, *Nature* **167**, 614 (1950).
8. F. G. G. TATE, *Alcoholometry*, p. 33, H.M.S.O., London, 1930.
9. VIOLETTE, *Ann. chim.* [3], **23**, 475 (1848).
10. T. URBAŃSKI and E. TEŚIOROWSKI, unpublished work (1931).
11. J. D. BLACKWOOD and F. P. BOWDEN, *Proc. Roy. Soc. (London)* **A213**, 285 (1952).
12. M. BERTHELOT, *Ber.* **2**, 57 (1869).
13. G. DICKSON and T. H. EASTERFIELD, *J. Chem. Soc.* **74**, 163 (1898).
14. O. DIMROTH and B. KERKOVIVUS, *Ann.* **399**, 120 (1913).
15. H. MEYER and K. STEINER, *Monatsh.* **35**, 391, 475 (1914).
16. E. PHILIPPI and G. RIE, *Ann.* **428**, 287 (1922).
17. E. PHILIPPI and R. THELEN, *Ann.* **428**, 296 (1922).
18. B. JUETTNER, *J. Am. Chem. Soc.* **59**, 208, 1472 (1937).
19. T. URBAŃSKI, W. HOFMAN, R. OSTROWSKI and M. WITANOWSKI, *Bull. Acad. Polon. Sci., sér. chim.* **7**, 851, 861, (1959); *Chemistry & Industry* **1960**, 95.
20. Hercules Powder Co., according to BACCHUS, *The Expl. Engineer*, Wilmington, April 1923.
21. F. RASCHIG, Ger. Pat. 257319 (1911); *Angew. Chem.* **25**, 1194 (1912).
22. SCHWARTZ, *Dinglers polyt. J.* **226**, 512 (1877).
23. P. SEIDLER, Ger. Pat. 78679 (1893).
24. F. RASCHIG, Brit. Pat. 29696 (1912).
25. A. VOIGT, Ger. Pat. 260311, 260312 (1911); 267542 (1912).
26. ANDREW NOBLE, *Artillery and Explosives*, London, 1906.
27. H. THOMAS, according to J. TAYLOR [5].
28. A. LANGHANS *Z. ges. Schiess- u. Sprengstoffw.* **14**, 55 (1919).
29. REISET and MILLON, *Compt. rend.* **16**, 1190 (1843).
30. GAENS, Ger. Pat. 37631 (1885); Brit. Pat. 14412 (1885).
31. D. J. B. MARKE and C. H. LILLY, *J. Sci. Food Agric.* **2**, 56 (1951).
32. C. BERTHOLLET, *Ann. chim.* **9**, 22 (1818).
33. DESIGNOLLE, according to R. ESCALES [56].
34. BRUGÈRE, *Compt. rend.* **69**, 716 (1869).
35. According to P. F. CHALON, *Les explosifs modernes*, Béranger, Paris & Liège, 1911.
36. E. A. STARKE, U.S. Pat. 513737, 527563 (1894).
37. RENÉ DESCARTES, *Les principes de la philosophie*, Elsevier, Amsterdam, 1644.
38. J. GAY-LUSSAC, *Rapports de la Comité des Poudres et Salpêtres*, 1823.
39. G. PIOBERT, *Mémoires sur les poudres de guerre*, Paris, 1844.
40. M. CHEVREUIL, according to R. ESCALES [56], p. 406.
41. R. BUNSEN and SHISHKOV, *Pogg. Ann.* **102**, 325 (1857).
42. J. LINCK, *Ann.* **109**, 53 (1859).
43. M. KAROLYI, *Pogg. Ann.* **118**, 546 (1863); *Jahresber. Chem.* 743 (1863).
44. N. P. FIODOROV, *Z. f. Chem.* (1863).
45. ANDREW NOBLE and F. ABEL, *Phil. Trans. Roy. Soc.* **165**, 49, 105 (1875); **171**, 203 (1880).
46. M. BERTHELOT, *Compt. rend.* **82**, 487 (1876).
47. H. DEBUS, *Ann.* **212**, 257; **213**, 15 (1882).

48. K. A. HOFFMANN, *Sitzungsber. Preuss. Akad. Wissenschaft.* **25**, 509 (1929); **26**, 434 (1930).
49. ANDREW NOBLE, *Fifty Years of Explosives*, London, 1907.
50. T. OZA and S. SHAH, *J. Indian Chem. Soc.* **20**, 261, 286 (1943).
51. H. KAST, *Spreng- u. Zündstoffe*, Vieweg & Sohn, Braunschweig, 1921.
52. W. WILL, *Z. ges. Schiess- u. Sprengstoffw.* **1**, 209 (1906).
53. P. VIEILLE, *Mém. poudres* **6**, 256 (1893).
54. W. H. RINKENBACH and W. O. SNELLING, in KIRK and OTHMER (Ed.), *Encyclopedia of Chemical Technology*, Vol. 6, Interscience, New York, 1951.
55. K. K. ANDREYEV, *Dokl. Akad. Nauk SSSR* **1945**, 49; *Zh. fiz. Khim.* **20**, 467 (1946).
56. R. ESCALES, *Schwarzpulver und Sprengsalpeter*, Veit & Co., Leipzig, 1914.
57. P. PASCAL, *Explosifs, poudres, gaz de combat*, Hermann, Paris, 1925.
58. I. A. VYSHNEGRADSKII, according to *Bolshaya Sov. Encyklopedya* **9**, 541 (1951); O. GUTTMANN, *Die Industrie der Explosivstoffe*, p. 222, Vieweg & Sohn, Braunschweig, 1895.
59. T. J. RODMAN, *Properties of Metals for Cannon and the Quality of Cannon Powder*, C. H. Crosby, Boston, 1861, according to J. TAYLOR [5].
60. Reproduced from *Chemical & Engineering News*.

CHAPTER IV

COMPOSITE PROPELLANTS FOR ROCKETS

GENERAL INFORMATION

BLACKPOWDER was the oldest known and the only propellant used in rockets up to time of World War II. It is a slow-burning powder with a high content of charcoal (p. 330).

Blackpowder is still used in small rockets (e.g. signal or rescue rockets for carrying the rope from shore to ship or vice versa). Its limited application is due to the fact that blackpowder gives a very low specific impulse: I_s = from 40 to 80 sec, which is much lower than that of modern composite propellants and smokeless rocket powders which give a specific impulse of 180–200 sec.

Smokeless (double base, i.e. nitroglycerine) powder, however, has some disadvantages which limit its use. It is difficult to produce in large-size charges and production involves costly investments. It is also dangerous to manufacture due to the use of nitroglycerine as an ingredient. In addition the powder requires periodic testing of the stability. It was for this reason that during World War II and afterwards composite propellants were introduced consisting of two essential ingredients: solid oxidant and solid fuel.

Solid composite propellants are usually rich in combustible ingredients and the amount of oxidant is usually limited by the mechanical properties of the mixtures. Careful choice of components is needed to obtain high loadings without jeopardizing fluidity in mixing and creating discontinuities in the binder. A common procedure consists of using oxidants in two or more sizes.

Mishuck and Carleton [1] classify rocket propellants into:

- (1) Polymerizable, castable (e.g. polysulphide–ammonium perchlorate mixtures);
- (2) Nonpolymerizable, castable, gel-type (cast double base powder);
- (3) Vulcanizable, non-castable (rubber–ammonium nitrate).

The most popular are the polymerizable, castable systems (group 1). They offer a great versatility in the choice of polymerizable monomers.

Rheological properties are very important in mixing and processing the compositions. Thus sedimentation of suspended solid before curing ought to be negligible. Casting must be sufficiently fluid to allow the escape of gas-bubbles. It is necessary

to know how the viscosity of a homogeneous liquid is modified by high loading with suspended solids.

A general discussion of the factors important in choosing the composition and methods of manufacture of the composite propellants was given by Mishuck and Carleton [1].

The following salts are commonly used as oxidants: potassium, sodium or ammonium nitrates and potassium or ammonium perchlorates. Lithium perchlorate was also suggested but seems to be used in an experimental scale only.

Solid fuels are mainly plastics or elastomers which, apart from functioning as combustibles, also serve to provide the rigidity. Occasionally a combustible and

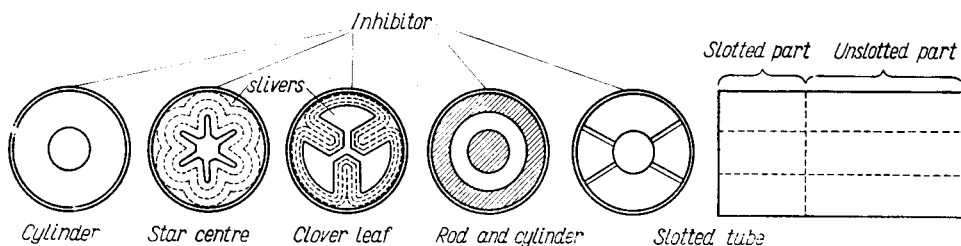

FIG. 107. Charge shapes (cross sections).

explosive substance such as nitrocellulose in a colloid form may act as the plastic component.

Other compositions are similar to pyrotechnic mixtures containing explosive substances, e.g. salts of picric acid.

To increase the heat energy emitted during the reaction metallic powders may be added, e.g. aluminium. Charcoal or soot are added sometimes to make the mixture burn smoothly.

The advantage of the majority of the mixtures concerned lies in the cheapness and stability of their ingredients, which do not decompose during storage and the uncomplicated and relatively safe method of manufacture. Periodic chemical stability testing for smokeless powders, which necessitates a suitable organization and entails a high expenditure, is unnecessary.

A general requirement is that the average molecular weight of exhaust gas should be low. This restricts the choice of solid propellant components to those containing elements of low atomic weight. Low atomic weight elements often release a greater heat of reaction.

Very little is known about the burning mechanism of these mixtures. There is a "two-temperature" theory of propellant combustion [2, 3].

According to this theory the rate-controlling reactions are associated with the gasification (pyrolysis) of the solid oxidant and the solid binder which in a composite propellant are essentially independent of each other.

The modern grains have their outer surface protected by an inhibiting layer and they burn from the inner surface created by differently shaped cores. Cross

sections of some typical charge are shown in Fig. 107. The purpose of the different shapes is to permit the rocket to operate at constant pressure by keeping the burning surface constant. The most commonly used charge design has a star-shaped core or some similar shape (e.g. clover leaf) [4, 5]. The thrust-burning time curves of cylindrical and star-shape charges are given in Fig. 108.

The star-shaped charge leaves slivers which burn out at low pressure and this leads to impulse losses. The slivers may remain unburnt and their weight is then

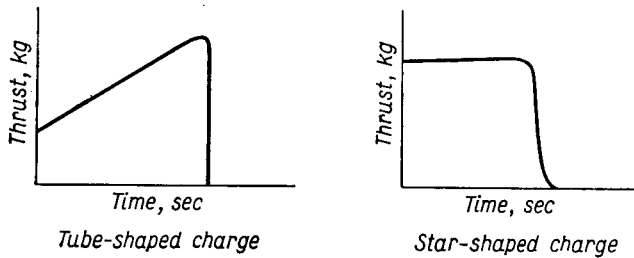

Fig. 108. Thrust-burning time curves of cylinder- and star-shaped charges.

added to the payload. Rods and cylinders do not leave slivers, but supporting the central cylinder may present some difficulty and a tube slotted at the nozzle end seems to be a more practical design [4].

MIXTURES WITH THE SALTS OF PERCHLORIC ACID

Mixtures composed of the salts of perchloric acid and an elastomer or plastic polymer are now the most popular of the composite propellants.

Mixtures containing potassium perchlorate are characterized by a relatively high rate of burning, high exponent n in the equation $V = kp^n$ and a high flame temperature. When burning they produce a dense smoke. Mixtures containing ammonium perchlorate have a lower rate of burning, low exponent n and flame temperature and yield less smoke. The rate of burning of these mixtures is however higher than that of similar mixtures with ammonium nitrate. Andersen *et al.* [3] found that a composite propellant with 75% ammonium perchlorate and 25% copolymer of polyester and styrene burns under a pressure of 6 kg/cm² at 15°C with a rate of 0.64 cm/sec, i.e. 2–3 times faster than corresponding mixtures with ammonium nitrate.

The forerunner of the rocket propellant containing perchlorates as oxidants was the American product, Galcitt, developed in the Jet Propulsion Laboratory (JPL) of the Guggenheim Aeronautical Laboratory, at the California Institute of Technology. It consisted of asphalt as a fuel and potassium perchlorate as an oxidant, mixed hot. Originally the material was hot-pressed into rockets. However, at high pressures the flame penetrated between the charge and the walls

of the rocket, causing an abrupt increase of the burning surface and consequently of the pressure, so the modification was introduced of pressing the material into blocks, which were not in contact with the walls of the rocket.

This composition was useless outside certain temperature limits, i.e. outside the range 4–38°C (40–100°F), the mixture becoming brittle and breakable at lower temperatures, and soft and shapeless at higher ones.

Zaehringer [6] gives the following composition for Galcit Alt 161:

Potassium perchlorate	75%
Asphalt with mineral oil or resin	25%

Resin was added to the asphalt to raise its softening temperature. Specific impulse I_s was 186 sec at 1350–3700 lb/in² pressure range.

MIXTURES OF PERCHLORATES WITH ELASTOMERS. THIOL PROPPELLANTS

Some of these propellants are apparently very popular. They are probably the cheapest composite propellants now in use.

T. L. Smith [7] discusses the properties required in elastomeric binders and the mechanical properties of solid cast-in-place case-bonded propellants. He considers that the most important mechanical property required in composite propellants containing an elastomer and intended for case-bonded grains is a relatively large ultimate elongation over a range of temperature and strain rate of experimental time scale. Moreover, the propellant grain must not creep excessively during rocket storage, and the grain must not crack or deform excessively under flight acceleration forces.

According to T. L. Smith an ideal elastomeric binder should have low "glass" temperature, should exhibit high elongation over a wide temperature range, should be cross-linked preferably through stable covalent bonds, and should not crystallize spontaneously during storage at any temperature.

The uncured binder material should be a liquid which cures with minimum heat release and shrinkage and without evolution of gases.

The binder should not be a solvent of the oxidant and should be chemically stable for long periods in close contact with the oxidant.

A more detailed discussion of the visco-elastic properties of rubber-like elastomers for composite propellants was recently given in a paper by Landel and T. L. Smith [8].

Among the composite propellants containing elastomers, those containing polyethylene sulphide "rubber", so called Thiokol, are widely used. Since 1950 they have been developed by the Thiokol Chemical Corporation in the U.S.A. under the general name of "Thiokol Propellants".

These compositions consist of thiokol and perchlorate, most probably in proportions:

Thiokol 20-40%
Perchlorate 80-60%

As there is no certainty that common solid thiokol produced in the form of latex should give a sufficiently homogeneous mass, Thiokol Corporation have worked out a method of starting with liquid thiokol which is then "cured".

As a rule, the liquid thiokol, mixed with an oxidant and an accelerator is poured into a prepared rocket chamber and cured *in situ* when the charge is solidified.

Liquid thiokol

The basic ingredient of the mixtures is liquid thiokol.

According to descriptions published by the Thiokol Chemical Corporation [9] and Göbel [10] liquid thiokol is obtained in the following way: ethylene chlorohydrin is condensed into dichlorodiethylformal (I) which is then treated with sodium polysulphide to form the polymer (II):

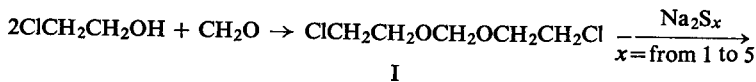

I



II

Other dichloro compounds may be used instead of dichlorodiethylformal, e.g.: 1,2-dichloroethylene, 1,3-dichloropropylene, dichlorodiethyl ether, dichlorotriethyl ether which, however, have never yet been put to practical application.

There are now six types of Thiokol Liquid Polymer (LP for short) in commerce: LP-2, LP-3, LP-31, LP-32, LP-33, LP-8 (see Table 83).

TABLE 83

	LP-31	LP-2 and LP-32	LP-3 and LP-33	LP-8
Physical state	Mobile liquid	Viscous liquid	Mobile liquid	Mobile liquid
Colour	Amber	Amber	Amber	Amber
Specific gravity at 20°C	1.31	1.27	1.27	1.27
Viscosity at 25°C (cP)	80,000-140,000	35,000-45,000	750-1500	250-350
Average molecular weight	7500	4000	1000	500-700
<i>n</i> (in the formula II)	42	23		
pH (water extract)	6.0-8.0	6.0-8.0	6.0-8.0	6.0-8.0
Stability (years)	over 3	over 3	over 3	over 3
Moisture content (%)	max. 0.2	max. 0.2	max. 0.2	max. 0.2

The difference between these polymers lies in the degree of polymerization or cross-linking. Thus LP-2 and LP-32 are cross-linked polymers. Of these two types the cross-linking of polymer LP-32 is weaker, therefore the modulus of elasticity of LP-32 (after curing) is smaller. The bursting stress of cured LP-32 is twice that of cured LP-2.

A similar difference exists between LP-3 and LP-33. Polymer LP-33 differs from LP-3 in having a weaker cross-linking.

The viscosity of polymers LP depends to a high degree on temperature.

Thus for a sample of Thiokol LP-31:

at 26.7°C (80°F) the viscosity was *ca.* 120,000 cP

at 48.9°C (120°F) the viscosity was *ca.* 28,000 cP

at 71.1°C (160°F) the viscosity was *ca.* 10,000 cP

At 25°C Thiokol LP-2 had a viscosity of 35,000–45,000 cP, but at 80°C the viscosity was only 5000 cP.

The curing of liquid thiokol is based on the reaction of the liquid polymer with lead dioxide or peroxides. Dehydrogenation of the terminal groups of the mercaptan chains of the polymer then takes place followed by elongation of the chains. This reaction may be depicted as:

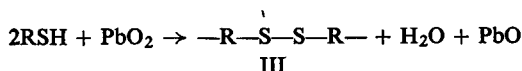

The lead oxide so produced and the lead oxide present as an impurity of lead dioxide may continue to react:

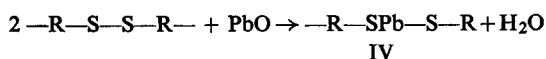

The lead mercaptide thus obtained may undergo oxidation during heat curing or on heating with a small amount of sulphur to form chain (III):

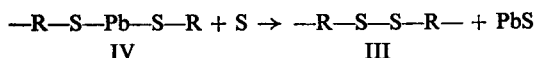

Three to five parts by weight of PbO₂ are usually used per hundred parts of LP.

Up to 0.5% of sulphur may also initiate the curing effect of lead dioxide. Conversely, the addition of fatty acids and their salts may exert an inhibitory influence upon the curing process of polymer LP. Thus the addition of one part by weight of stearic acid to polymer LP approximately doubles the curing time.

Peroxides (e.g. cumene hydroperoxide) are alternative curing agents. The reaction then proceeds according to the equation:

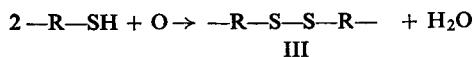

Approximately five parts by weight of hydroperoxide are used per hundred parts of polymer LP. The reaction may be accelerated by an alkaline medium, so

that a small (e.g. 0.2 part) amount of weak bases may be added e.g. benzyl-dimethylamine or tri(dimethylamino)-methylphenol (DMP-30).

Also noteworthy is the addition of an agent to increase mechanical strength (e.g. carbon black, titanium dioxide, zinc sulphide, lithopone) and plasticizers which usually serve to disperse the PbO_2 within the polymer.

Thiokol Chemical Corporation suggests the following compositions for B (Base compounds) (in weight units):

TABLE 84

Composition of B compounds	LP-31	LP-2	LP-32
Thiokol LP	100	100	100
Carbon black	—	30	30
Soot or zinc sulphide or lithopone	30-50	—	—
Stearic acid	1	1	1
Sulphur	0.15	—	0.1

The composition of C (Curing compound) is:

PbO_2	50%
Stearic acid	5%
Dibutyl phthalate	45%

B compound is mixed with C compound in the proportions of hundred parts of Thiokol LP to ten to fifteen parts of C compound.

Thiokol Chemical Corporation gives the following characteristics of polymers LP-2 and LP-32 cured in 24 hr at 26.7°C (80°F) and then pressed for 10 min at $175-190^\circ\text{C}$ ($287-310^\circ\text{F}$):

TABLE 85

	LP-2	LP-32
Tensile strength lb/in ²	500	550
300% modulus lb/in ²	350	250
Crescent tear index	125	145
Shore A hardness	50	45
Low temperature flexibility ($^\circ\text{F}$)	-65	-65
High temperature resistance ($^\circ\text{F}$)	275	275
Ozone resistance	excellent	excellent
Sunlight resistance	excellent	excellent
Ageing resistance	excellent	excellent

Cured polymers obtained in this way show very high resistance to such solvents as petrol, water and ethanol. On the other hand they swell and absorb ketones, esters (ethyl acetate) and carbon tetrachloride.

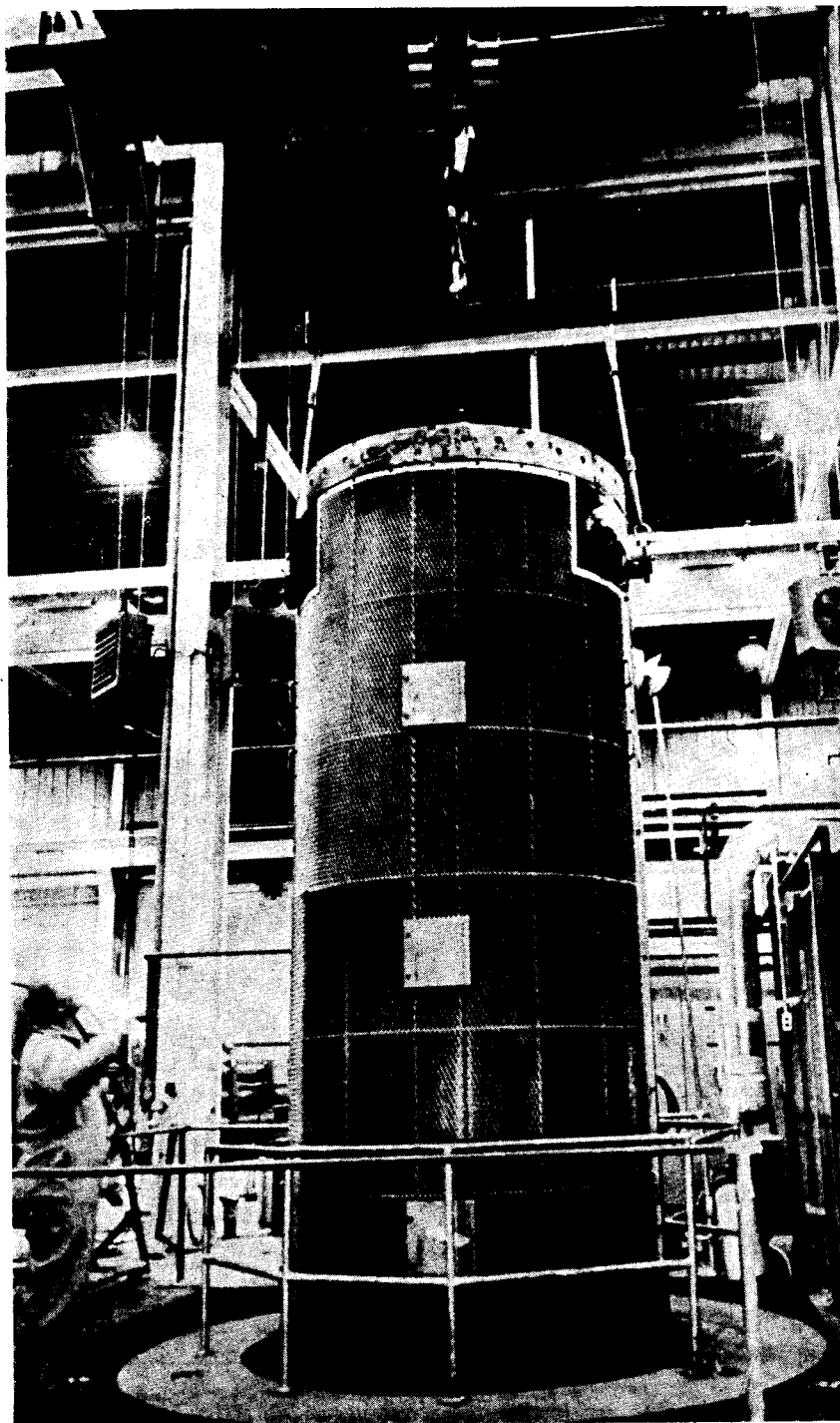

FIG. 109. Rocket chamber being lowered into a vapour degreasing pit to remove all traces of grease and oil (according to Dykstra [11]).

THE TECHNOLOGY OF THE MANUFACTURE OF ROCKET CHARGES CONTAINING COMPOSITE PROPELLANTS WITH THIOKOL

It is characteristic of the technology of the manufacture of rocket charges containing composite propellants with thiokol that the semi-liquid mixture is poured directly into the rocket chamber lined from within with an insulating layer to which the charge adheres tightly ("case-bonded" charge). This is a very cheap and rapid method of manufacture.

Warren [5] describes the following stages of manufacture as used at the Thiokol Chemical Corporation's Redstone Arsenal, Huntsville, Alabama:

- (a) chamber preparation,
- (b) oxidant preparation,
- (c) mixing,
- (d) casting,
- (e) curing,
- (f) finishing and inspection.

Chamber preparation (Case-bonded propellants)

The rocket chamber itself is used as the mould. The inner surface of this chamber must be very carefully cleaned so that the propellant will be well bonded to it. Any rust or foreign material should be removed by wire brushing or sand blasting. After that, particles loosened by this operation, together with any grease or oil which may be present, are removed by a vapour-degreasing, trichlorethylene being the most popular degreasing agent. With large units the solvent is poured directly into the chamber which is then rotated and brushed at the same time (Fig. 109).

Most propellant manufactures apply an insulating lining to the chamber surfaces to protect the metal wall. The propellant itself is an insulator during most of the burning, so presumably the lining acts as an insulator only during the final burnout. Another important function of the lining is to inhibit burning on the outside of the charge where there is a poor bond to the metal case. The same binder that is used in the propellant, but without the oxidant, makes an effective lining. It is generally sprayed on and polymerized in place by a short curing treatment at an elevated temperature. The thin layer provides an excellent surface to which the propellant can be bonded.

While chamber preparation is going on the cores or "risers" are prepared to act as moulds for the perforation of the charge. The cores can be placed in the rocket chamber prior to casting and held in place by special supports, but usually they are added after the propellant has been cast. Precise alignment of these cores is of the utmost importance. A star-shaped core is given in Fig. 110.

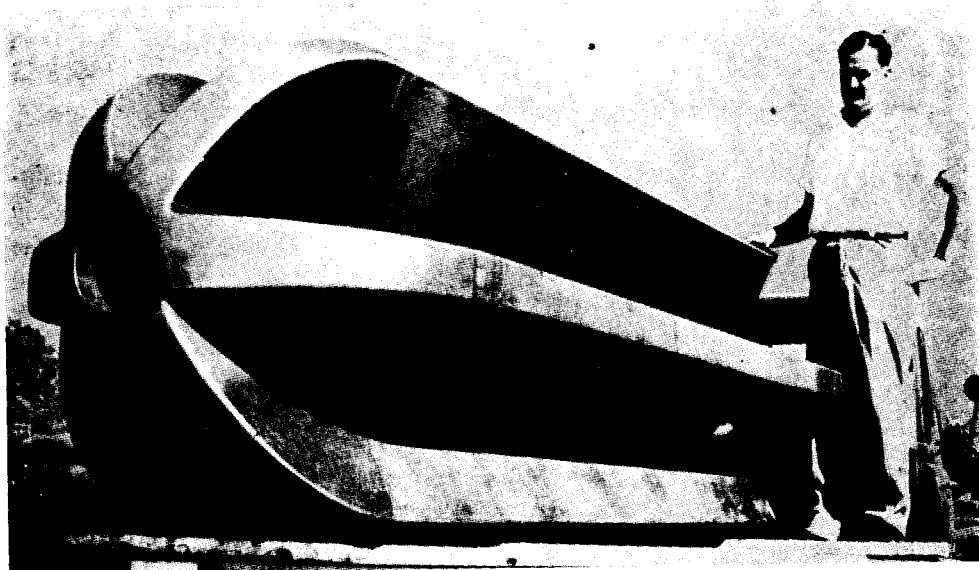

FIG. 110. Charge with a star-shaped core (Thiokol Chemical Corporation, according to Chapman [12]).

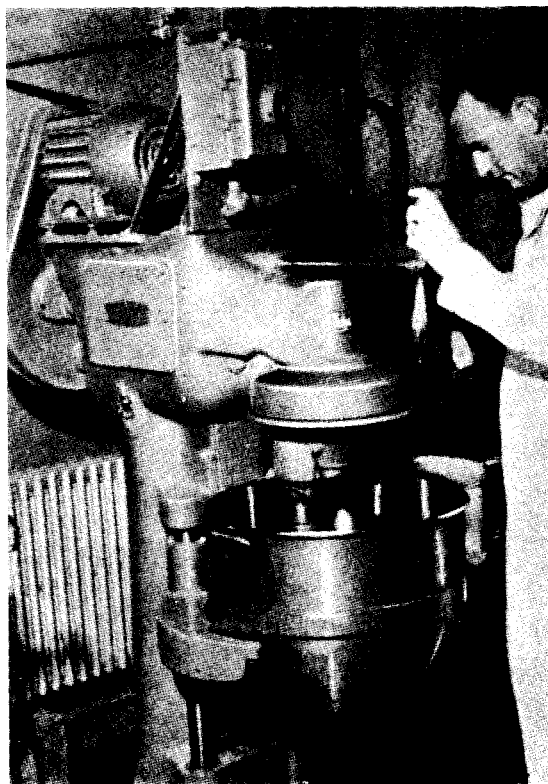

FIG. 111. A double-motion paddle mixer for premixing Thiokol propellant (Thiokol Chemical Corporation, Redstone Arsenal, according to Warren [5]).

Preparation of the oxidant

Inorganic oxidants are used exclusively in composite propellants; their properties have already been discussed. Huggett [13] draws attention to the importance of the particle size of the finely ground potassium perchlorate in compositions. They should be ground with extreme care.

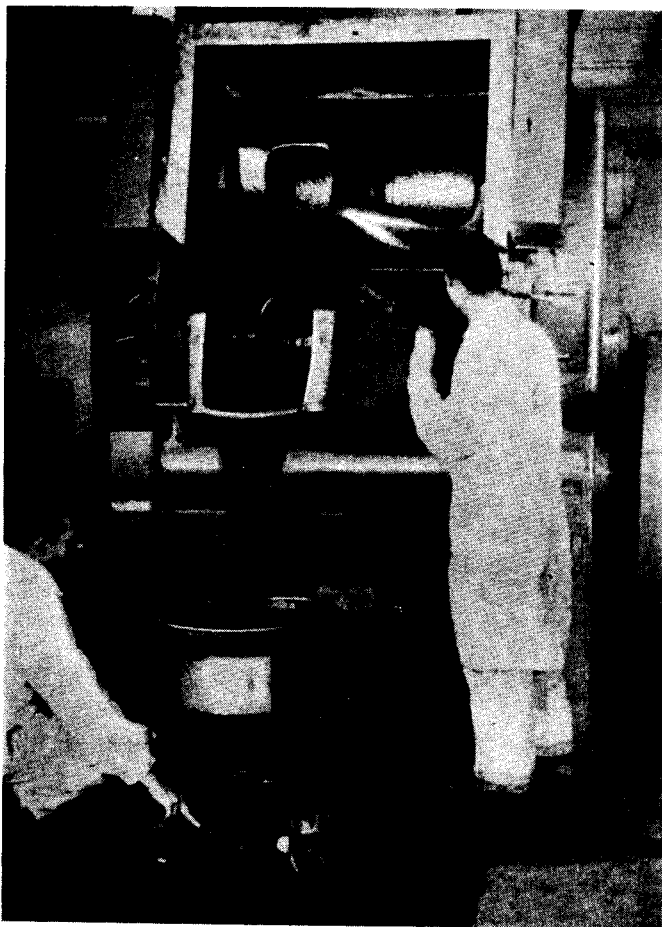

FIG. 112. Removal of propellant from mixer to transport vessel (Thiokol Chemical Corporation, Redstone Arsenal, according to Warren [5]).

By using a suction mill and operating under conditions of controlled humidity, uniform particles of 2–10 μ can be obtained. The oxidant is ground only in the quantities needed for each batch and is never stored in a finely-ground state as the fine particles have a tendency of “caking” and agglomerating into larger ones. The grinding operation is not without its hazards and extreme care must be exercised, especially with the perchlorates.

Mixing

A "premix" is prepared by mixing the fuel binder (i.e. a polysulphide rubber in the case of the Thiokol propellant) with the necessary curing agents, inert additives, and ballistic modifiers in a double-acting paddle mixer. This mixer is equipped

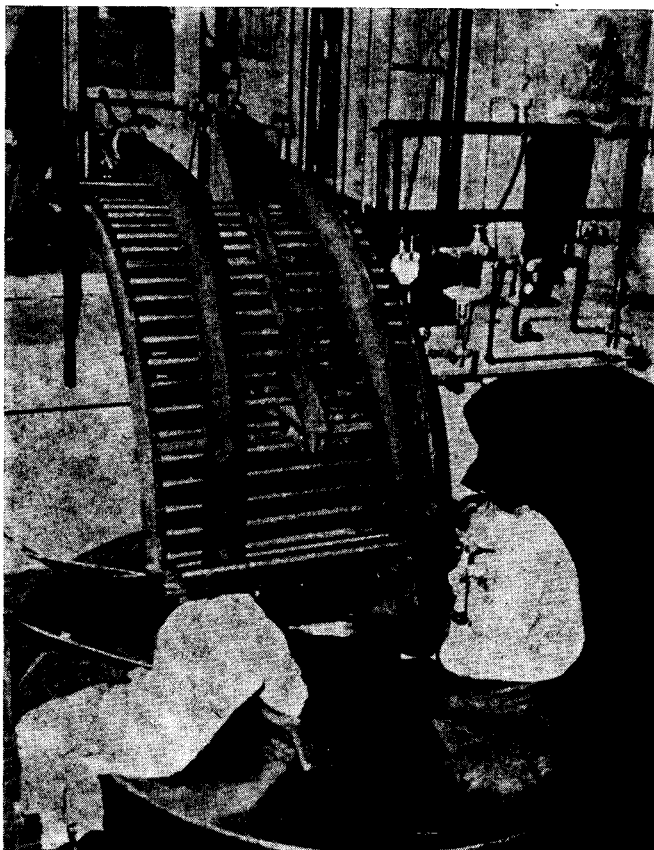

FIG. 113. Casting propellant around a star-shaped core, according to Dykstra [11].

with a paddle rotating on a shaft located off center in the mixing vessel. As the shaft rotates it also revolves about the central axis of the vessel, so that it operates in all parts of the vessel in turn. Figure 111 shows the paddle mixer in operation. (Different fuels may require different mixing systems.) When the premix has been thoroughly blended it is transferred to a larger mixer.

The final mixing takes place in a large Werner-Pfleiderer (or Baker-Perkins) type sealed mixer of the type extensively used in smokeless powder manufacture (Fig. 206). A capacity up to 2000 lb is used in the case of thiokol propellants. After the premix has been added to the mixer, the finally ground oxidant is added. This material is conveyed to the mixer in a closed container and is added so that the

container and mixer remain cut off from the outside air. Mixing is continued at a controlled temperature until the mixture becomes uniform. The duration of the mixing depends on the material used. The blended material is very viscous, but still pourable

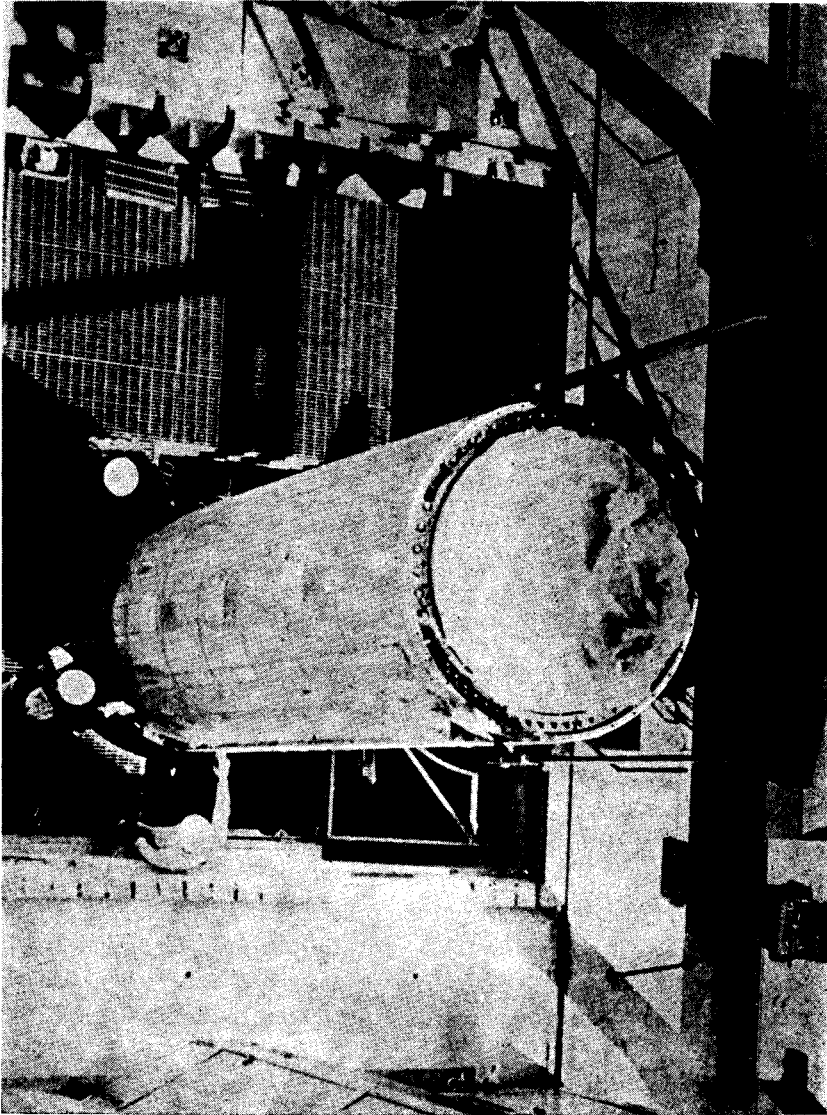

FIG. 114. The rocket chamber with the cured propellant is removed from the curing oven, according to Dykstra [11].

and is poured into a transfer vessel for transportation to the casting room (Fig. 112). Here, it should be de-aerated under vacuum prior to casting to ensure uniform burning characteristics.

Casting

There are several ways of filling the rocket chamber with the propellant. It can be introduced through a long tube ("bayonet") which is lowered into the chamber or it can be added through the bottom of the tank. The material is cast into the

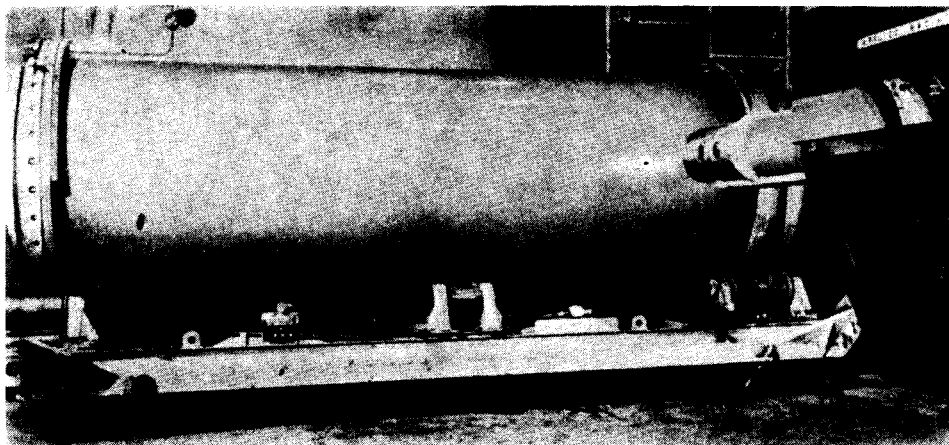

FIG. 115. X-Ray inspection of the 65.5 in. dia. cast propellant, according to Dykstra [11].

chamber around the core (Fig. 113) or the core is lowered into the chamber after the propellant has been cast in the rocket chamber. The loaded motor chamber is then sent to the curing ovens.

Curing

The filled chamber is placed in an oven where the temperature is gradually raised at a given rate to a definite temperature (sometimes up to 150°C). At this temperature it is held for a determined time, the oven is then cooled to ambient temperature and the chamber removed from the oven (Fig. 114). Curing rate and curing time must be carefully controlled to obtain the desired physical and ballistic characteristics. After curing is complete, the cores are removed and excess propellant cut away. The "grain" is now ready for final inspection.

Inspection

Inspection during the course of the manufacture is extremely important. By chemical analysis the quality of most of the ingredients is maintained within specified limits. Visual inspection is made of chamber surface and lining condition before casting. Sieve analysis should be used to check the particle size of the oxidant. As with most plastic materials, control of the quality of the product can be assured only by careful control of the variables affecting the polymerization of the material.

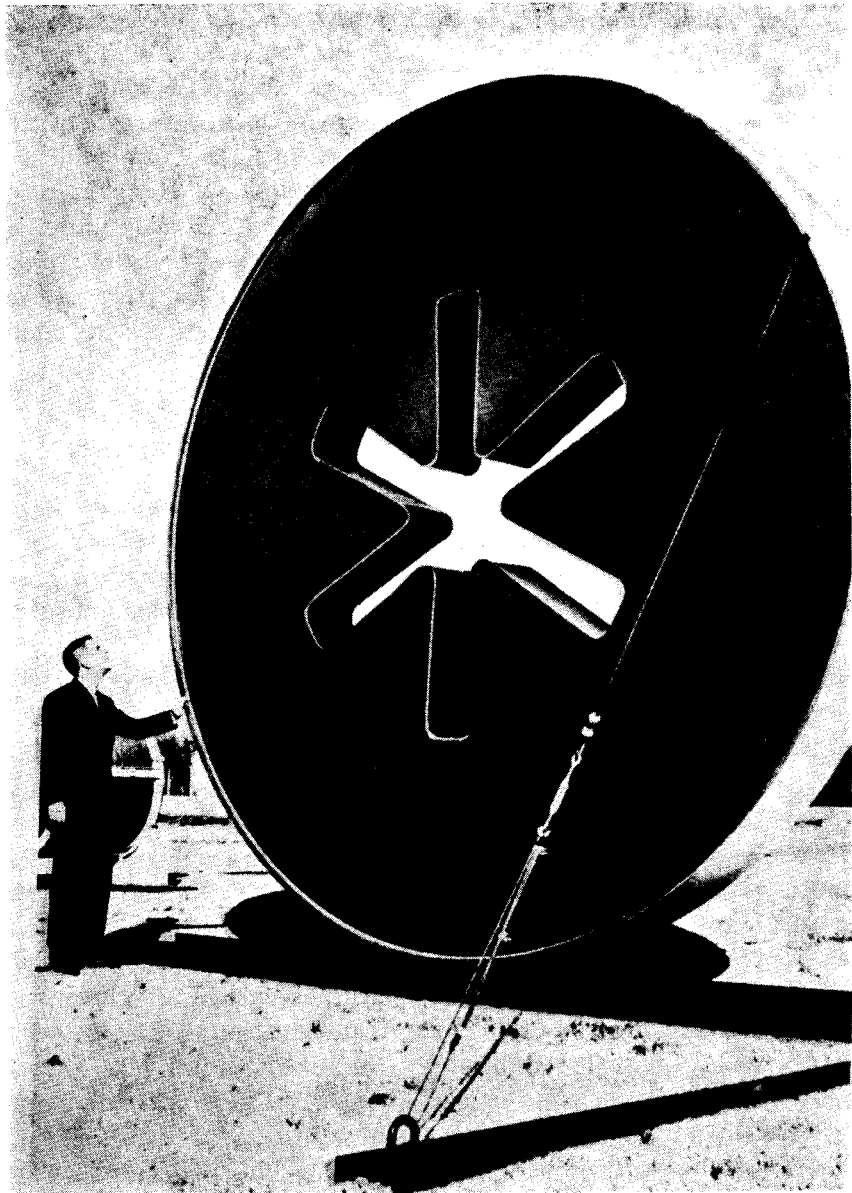

FIG. 116. Cross-section of a Thiokol propellant for 14 ft dia. rocket 63 ft in length [14].

Temperature, time, rate of mixing and quantity of ingredients are important variables.

Once the materials have been mixed, it becomes very difficult to analyse quantitatively for individual ingredients. This is especially true when curing is complete. After curing, the propellant grain and chamber pass through a series of inspections including weighing, radiography, X-ray (Fig. 115), fluoroscopic examination, gauge

measurements, and checking with optical comparators. Small rockets can be given a final check by the static or flight testing of a random sample. With large rockets, such testing becomes too expensive and must therefore be kept to a minimum.

Inspection for storage stability, a most important factor in the case of the nitric esters, is a different matter with composite propellants. These compositions unlike nitrocellulose do not undergo spontaneous decomposition. However, composite systems do undergo a change in character during storage. Burning properties and physical characteristics (e.g. tensile strength) may change continually with time. By improving the composition and curing techniques these changes can be reduced considerably. Figure 116 gives a cross-section of a thiokol propellant "grain" of a 14 ft dia. rocket.

MIXTURES OF PERCHLORATES WITH OTHER ELASTOMERS

Among the possible alternatives synthetic rubber may be mentioned. In particular the mixtures of potassium or ammonium perchlorates with butadiene-styrene copolymer are recommended.

There is, however, limited information on the method of manufacture and on the properties of these compositions.

Among various elastomers recently recommended as combustible ingredients of composite propellants polyurethanes are particularly important and promising [15]. Three basic building blocks are used for polyurethane-rubber fuel-binder: di-isocyanates, low-molecular weight triols and long-chain diols—linear organic compounds terminated at each end by hydroxyl groups with molecular weights from 1000–2000.

New copolymer diols derived from ethylene oxide and tetrahydrofuran yield linear polyurethanes of superior physical properties [16].

The chief problem in the manufacture of polyurethane propellants lies in determining the point where the liquid, uncured propellant is reduced to the uniform consistency necessary to obtain reproducible ballistic performance.

MIXTURES OF PERCHLORATES WITH PLASTICS

Among the plastics which in addition to being combustible ingredients of these mixtures serve also as binders imparting mechanical strength to the charges, the following substances have recently become of considerable interest: methyl methacrylate, polystyrene.

The use of polyethylene has also been mentioned. So far the best-described mixtures are those with methyl methacrylate. Mixtures with ammonium perchlorate go by the name of Aeroplex N, those with potassium perchlorate are known as Aeroplex K.

Among the few papers on the physico-chemical properties of these mixtures that of Alterman and Katchalsky [17] is noteworthy as it contains data on a number

of solid physico-chemical mixtures of methyl polymethacrylate with potassium perchlorate.

The figures obtained by the authors are given in Table 86.

TABLE 86

Composition (% by weight)		Density g/cm ³	Specific heat cal/g	Heat of decom- position kcal/kg	Flame temper- ature °K	Ignition temperature with 20 sec delay °K	Rate of burning (cm/sec) at pressures of:		
Methyl polymethacry- late	KClO ₄						30 atm	50 atm	100 atm
20	80	1.88	0.241	800	3750	925	1.41	—	—
22.5	77.5	1.88	0.247	832	3770	927	1.43	2.34	5.48
25	75	1.86	0.254	859	3778	930	1.38	2.33	—
30	70	1.82	0.267	828	3518	936	1.17	2.12	—

The very high flame temperature of the above mentioned mixtures is noteworthy. In the majority of smokeless nitrocellulose or nitroglycerine powders it is considerably lower: 2000–3000°K.

Attention has recently been paid to the possible use of alkyd type polyester resins as combustible binders of composite propellants. The use of polyester resins from maleic, adipic or phthalic acid has been suggested. Their main advantage is that they can be cured in the cold by the addition of styrene or diallyl phthalate. Curing the charges can thus be performed at a relatively low temperature.

These binders possess properties which are very important for ease of manufacture and for obtaining a uniform product. Thus they have low viscosity on casting without sedimentation of solids, have sufficient reactivity for complete low-temperature cure and evolve little heat on polymerization (e.g. much lower than heat of polymerization of methyl acrylate).

Noteworthy among the few reports in the literature on this subject is the work of Andersen, Bills, Mishuck, Moe and Schultz [3] on the mechanism of combustion of a mixture of 75% NH₄ClO₄ and 25% polyester with styrene. The work of Grodzinski [18] who investigated the thermal decomposition of the mixtures of various combustible substances with potassium perchlorate in a ratio of 20/80 by weight, is also of great interest. The combustible ingredients include asphalt and polyester resin from unsaturated (maleic) or saturated acids.

The following figures characterize the temperature at which explosion occurred after the lapse of a certain induction period or "time lag" (see Table 87).

The ignition temperature of a sample of the mixture of KClO₄ with unsaturated polyester resin introduced into a thermostat heated to 296°C, in relation to time, is shown in Fig. 117 (curve I). The curve resembles that given by Roginskii for nitroglycerine heated at 41°C in the presence of nitric acid as a catalyst (Vol. II, Fig. 11, p. 48). Here the temperature of the sample just before the explosion was 298°C,

TABLE 87

Combustible ingredient	Temperature °C	Induction period min
Asphalt	320	75
Saturated polyester resin	340	10
Unsaturated polyester resin	290	32
Polyethylene	440	15
Paraffin oil	440	56
Starch	265	4
Cotton linters	245	5
Graphite	305	2
Active carbon	315	3
Carbon black	440	3

i.e. only 2°C higher than the ambient temperature. Curve *II* represents the result of a similar experiment with a mixture of potassium perchlorate and ethylene glycol.

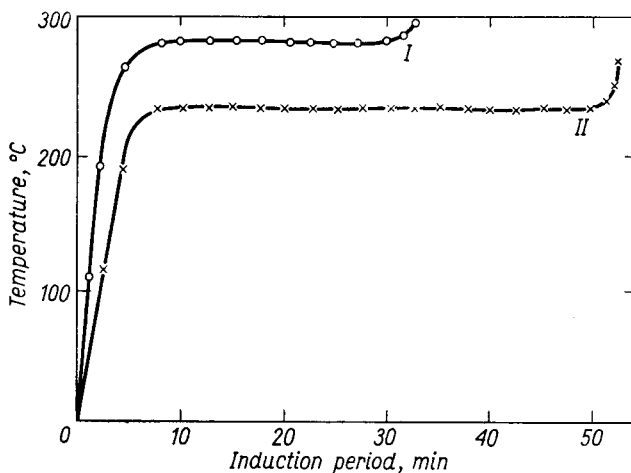

FIG. 117. Low-temperature explosions of mixtures of potassium perchlorate with some combustible substances: *I*—with polyester resin (temperature of the thermostat 296°C), *II*—with ethylene glycol (temperature of the thermostat 241°C), (according to Grodzinski [18]).

Grodzinski ascertained that the addition of potassium or lithium chlorate to these mixtures does not change the ignition temperature but reduces the induction period.

The exothermic decomposition of the mixtures of potassium perchlorate with charcoal at 300–360°C was studied by Gordon and Campbell [19].

Some technological information on the Aerojet General Corporation's composite propellants technology was published recently [20]. Ammonium perchlorate is ground to the particle sizes ranging from 1 to 200 μ and then mixed to form a blend of the various particle sizes which gives the best mechanical and ballistic properties. Ammonium perchlorate is mixed with liquid polybutadiene-acrylonitrile fuel, liquid plasticizer and aluminium powder (Fig. 118). The motor casing is coated internally



FIG. 118. Pre-mixing ammonium perchlorate with liquid polymer, plasticizer or aluminium (Aerojet General Corp. [20]).

with an antirust compound, insulated with silica-filled nitrile rubber and finally lined with polybutadiene-rubber polymer similar to the propellant fuel and binder (Fig. 119). The polymer is cured in the usual way. Casting the propellant is done through the "bayonets" from the casting pot to the case (Fig. 120).

MIXTURES WITH AMMONIUM NITRATE

Mixtures containing ammonium nitrate have recently been suggested as materials for rocket propulsion.

According to J. Taylor [21] potassium dichromate is an efficient catalyst of the decomposition of ammonium nitrate. J. Taylor and Sillitto [22] found that mixtures

for rocket propulsion, with ammonium nitrate as a chief component, should contain ammonium dichromate which facilitates the onset of the decomposition of ammonium nitrate and subsequently supports this decomposition.

These authors suggest the use of fusible mixtures containing ammonium nitrate (of the type described above—p. 253) from which the propellant "grains" are cast. The grains in the form of tubes have a high density and are suitable for rockets of small calibre.



FIG. 119. Preparation of the case (Aerojet General Corp. [20]).

The composition of two mixtures of this kind is given in Table 88.

These mixtures have a density of about 1.7. During decomposition they evolve 1150–1350 ml of gas per kg.

Other mixtures consist of ammonium nitrate activated with ammonium dichromate, for instance, plus a combustible ingredient also acting as a binder.

Little is known about the composition of these mixtures.

Phillips Petroleum in the United States [23] developed a propellant composed of ammonium nitrate as oxidant and rubber as a combustible and binding agent. The rubber consists of synthetic rubber and such typical rubber ingredients as carbon black (to improve the mechanical properties of rubber), an accelerator and an inhibitor (to prevent oxidation). To endow the rubber with sufficient plasticity

to yield a fairly homogeneous composition on mixing, a certain amount of plasticizer is added.

TABLE 88

	Oxidizing mixture	Mixtures giving complete combustion
NH_4NO_3	72	58
NaNO_3	16	—
NH_4Cl	4	—
Nitroguanidine	—	11.6
Dicyandiamide	—	7.2
$(\text{NH}_4)_2\text{Cr}_2\text{O}_7$	8	8
Melting point ($^{\circ}\text{C}$)	115–120	105

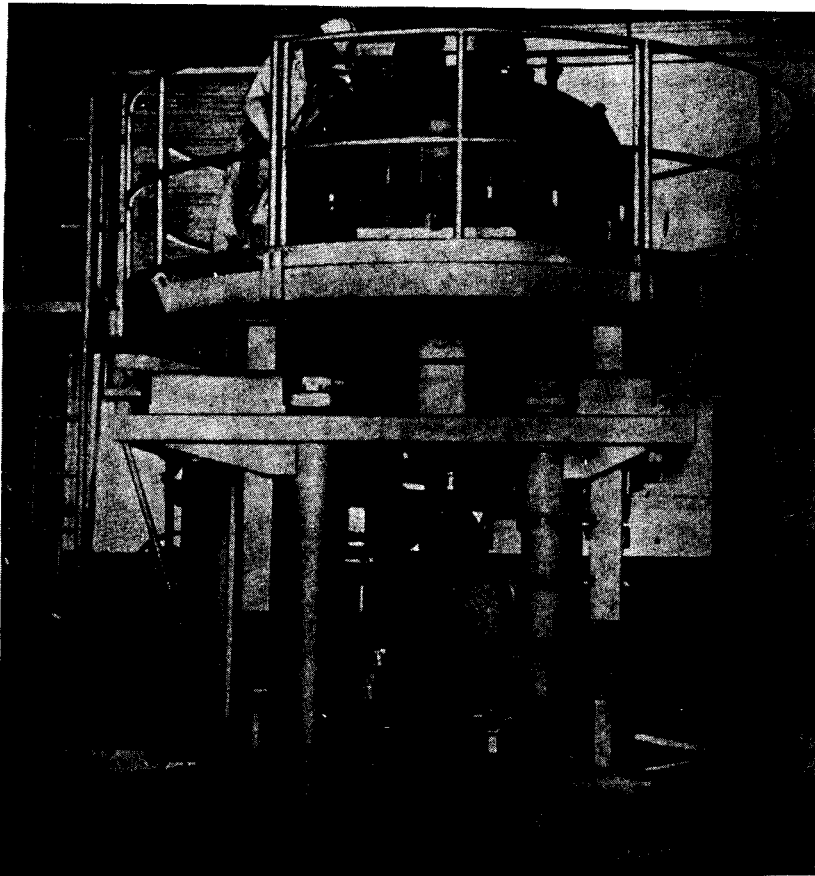

FIG. 120. Casting from the casting pot (on the top) down to the case through the "bayonets" (Aerojet General Corp. [20]).

As ammonium nitrate is a rather slow oxidant small quantities of a catalyst, presumably of potassium dichromate, are added to it.

The composition of the powder is:

Ammonium nitrate	83%
Combustion catalyst	2.3%
Synthetic rubber	10%
Carbon black	2%
Curing substance	0.4%
Plasticizer	2.0%
Inhibitor	0.3%

The manufacture of this powder consists of the following operations.

Milling

Ammonium nitrate is milled until granules with a particle size ranging from 5 to 500 μ are obtained. Fineness of grinding governs the rate of burning of the mixture.

Synthetic rubber is mixed with such ingredients as carbon black, plasticizer, accelerator and inhibitor. Mixing is carried out on the rollers commonly used in the rubber industry.

Final mixing

The milled ammonium nitrate and combustion catalyst are added to the fuel so formed, which at the same time acts as a binder. This final stage of mixing is carried out between rollers heated to 50–60°C. The temperature should not exceed 60°C. The final mixing last for $\frac{1}{2}$ –2 hr.

Pressing

The hot, homogeneous mass is shaped in a hydraulically-operated extrusion press of the type used for smokeless powder (Fig. 121). It is usually cruciform. A guillotine cuts the extruded material to the required length. The outer surfaces of the limbs of the cross are covered by a substance which does not burn readily (e.g. strips of plasticized cellulose acetate or polystyrene 1.5–5 mm thick), and cemented in place, to prevent uneven burning at the surface.

Curing

The final operation in propellant manufacture is the curing of the binder. The shaped material is placed in a curing oven for 16–48 hr at 80–110°C. The temperature and duration of this operation depend on the composition of the mixture, the dimensions of the charge and the physical properties desired.

After curing, the charges are given their final dimensions. In some rockets a high dimensional tolerance is admissible, and the final dimensions may be imparted before curing.

Dekker and Zimmerman [24] described a cast ammonium nitrate propellant containing polyester styrene-methyl acrylate binder.

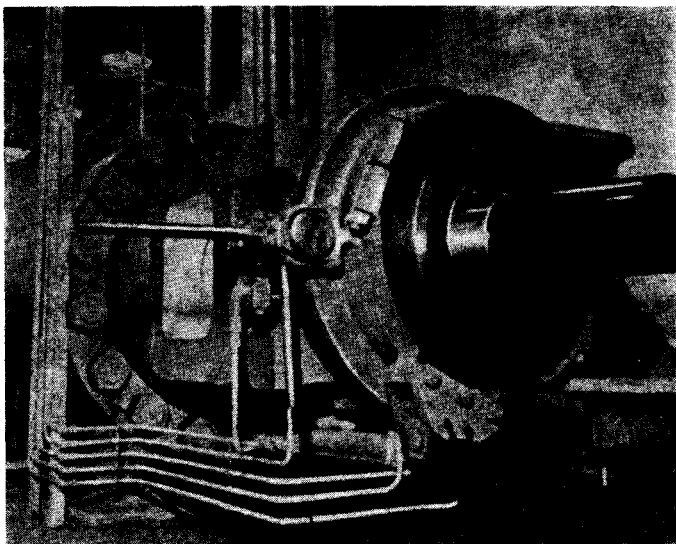

FIG. 121. Extrusion press for extruding ammonium nitrate composite propellants, Astrodyne, Inc. (according to Warren [5]).

A typical composition of AMT-2011 propellant was:

Ammonium nitrate	72.79%
Genpol A-20 polyester resin	9.79%
Methyl acrylate	12.22%
Styrene	2.22%
Methyl ethyl ketone	0.49%
Cobalt octoate	
(1% in styrene)	0.25%
Lecithin (10% in styrene)	0.25%
Ammonium dichromate	1.99%

The binder itself (Genpol A-20 polyester resin, styrene and methyl acrylate) was combined with the necessary polymerization catalyst (methyl ethyl ketone peroxide) and an accelerator (cobalt octoate or naphthenate).

The viscosity of the binder was adjusted by varying the ratio of polyester to monomer so as to achieve a castable composition (Fig. 122). Lecithin was used to reduce the viscosity.

The proportion of the oxidant could be as high as 82%. This gave a limit of pourability of the mixture. This high content of solid oxidant could be achieved by

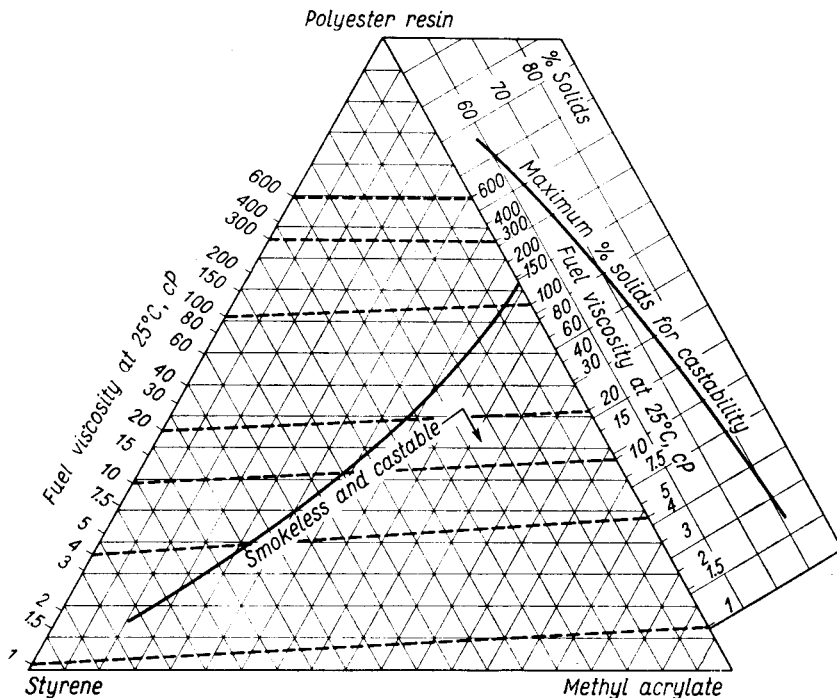

FIG. 122. Binder composition and viscosity. Smokeless and castable compositions are indicated with an arrow (according to Dekker and Zimmerman [24]).

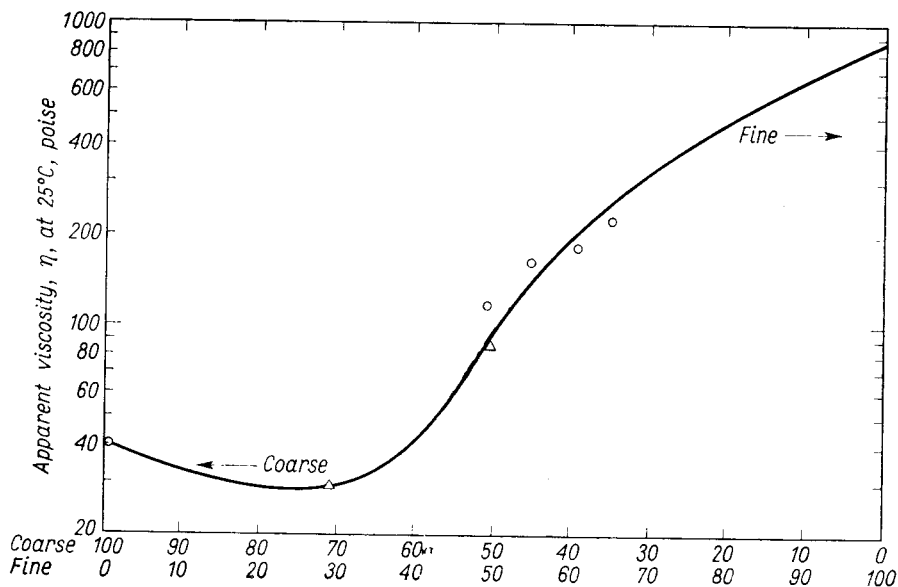

FIG. 123. Effect of blends of fine and coarse ammonium nitrate on viscosity of a propellant containing 64% by volume solids and 0.025% by weight lecithin. Binder viscosity was 20 cP (according to Dekker and Zimmerman [24]).

selecting ammonium nitrate of a specific particle size. By using two particle size ranges in which 70% was coarse and 30% fine (the size of fine crystals was approximately $\frac{1}{2}$ that of the coarse material) it was possible to obtain an oxidant with a high bulk density. Only a small quantity (18%) of uncured binder was sufficient to obtain a castable propellant.

Further increase of the proportion of the binder could be obtained by introducing a third distinctly different particle size.

The stoichiometric mixture was composed of 92% of ammonium nitrate and 8% of the fuel.

The specific impulse was relatively low (*ca.* 190 sec at 1000 lb/in²).

The propellants have found an application in auxiliary or emergency power units (JATO—jet assisted take off) for use in aircraft, with good performance in the range of -75 to 180°F (i.e. -59 to 82°C).

Greek, Dougherty and Mundy [25] give two typical formulations for castable and extrudable ammonium nitrate propellants (Table 89).

TABLE 89
TYPICAL PROPELLANTS WITH AMMONIUM NITRATE AS OXIDIZER

	Castable %	Extrudable %
Liquid polymer	10.8	—
Rubber polymer	—	12.0
Filler	—	2.5
Plasticizer	3.0	2.5
Curing agent	1.0	0.5
Anti-oxidant	0.2	0.4
Metal powder	16.0	—
Oxidizer	68.0	80.0
Catalyst	1.0	2.1

A general lay-out of the plant was given by the same authors (Fig. 124).

These propellants possess several advantages: they give smokeless exhausts, are non-corrosive and non-erosive, and have a low rate of burning and low flame temperature.

NEW METHOD OF MIXING INGREDIENTS OF COMPOSITE PROPELLANTS

A process for continuous pneumatic mixing of ingredients of solid composite propellants has recently been developed by the U.S. Naval Propellant Plant, Indian Head, Md., according to A. J. Colli [26]. The solid and liquid ingredients (oxidizers and prepolymer respectively) are conveyed pneumatically through a porous tube. Air flowing into the tube through the pores provides turbulent mixing. The process is shown diagrammatically in Fig. 125.

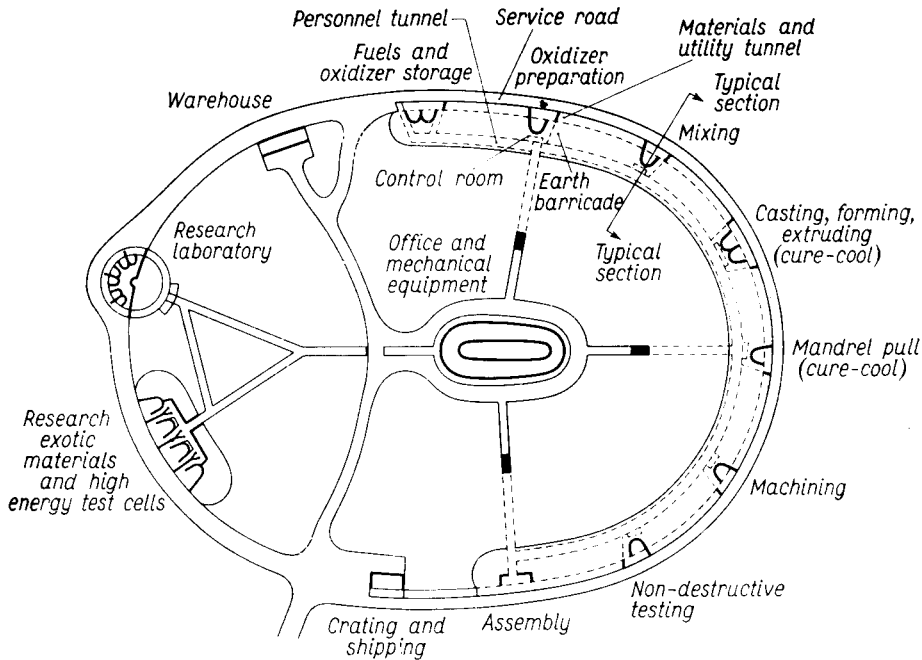

FIG. 124. Lay-out of the plant for ammonium nitrate composite propellants [25].

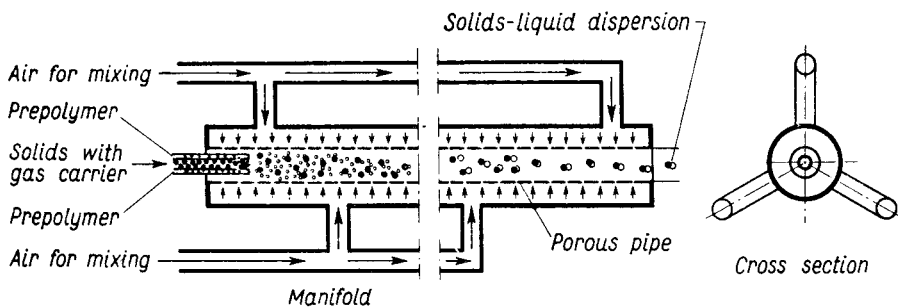

FIG. 125. Continuous mixer of composite propellants' components [26].

The mixture leaving the apparatus must be de-aerated. The air is removed from the solids-liquid dispersion by a centrifugal separator before the propellant is vacuum cast and cured.

The main purpose of utilizing a continuous process is to achieve a high degree of safety with a high output: only a very small quantity of material is present in the mixer at any given time, and the ingredients are in contact only for a fraction of a second. While handling only 1 lb in the mixer an output of 5000 lb per hour is achieved.

The carrier gas moves solids and droplets at random, providing intimate mixing. The gas also prevents the material from sticking to the wall of tube. As the solid

particles and associated liquid droplets move through the tube, uneven radial distribution between two phases disappears.

Extensive research on the burning mechanism of a mixture containing ammonium nitrate has been reported by Chaiken [2] and Andersen, Bills, Mishuck, Moe and Schultz [3].

These studies were based on the "two temperature" theory of propellant burning.

According to this theory it is assumed that in a composite propellant containing ammonium nitrate the oxidant starts to gasify at a temperature of about 600°K due to the endothermic reaction resulting in the formation of ammonia and nitric acid. These gaseous products then undergo exothermic redox reactions giving a flame of about 1250°K in the vicinity of burning substance. This temperature brings about the pyrolysis of the organic binder. The gaseous products of this reaction react in turn with the gaseous products of pyrolysis of the oxidant to create a hot flame of about 2400°K at a certain distance from the surface of the charge.

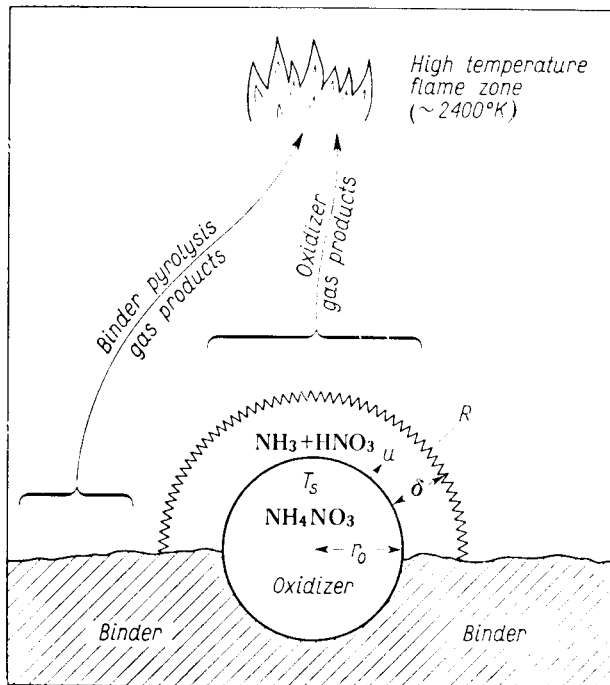

FIG. 126. Thermal layer model of combustion of solid composite propellant with ammonium nitrate, according to Chaiken [2]; R —redox reaction flame zone (temperature T_f), u —gas velocity, δ —thickness of the thermal layer, T_s —surface temperature of oxidizer particle, r_0 —radius of oxidizer particle.

The diagram (Fig. 126) given by Chaiken represents a simplified picture of this mechanism.

Andersen *et al.* [3] have examined a number of the mixtures of ammonium

nitrate and polystyrene with various molecular weights and determined experimentally the average temperature of the surface of the oxidant (573–599°K) and that of the binder (from 796°K for low-molecular polystyrene MW=142,000 to 979°K for high-molecular polystyrene MW=500,000).

In mixtures with methyl methacrylate the corresponding figures are: 562 and 950°K.

In mixtures with copolymer polyester–styrene the temperature of the oxidant is 582°K and that of copolymer 1020°K.

Andersen *et al.* obtained a similar result for mixtures of ammonium nitrate with copolymer polyester–styrene–acrylate and with copolymer butadiene–styrene.

They also suggest that the same mechanism applies to a mixture of ammonium perchlorate with copolymer butadiene–styrene.

The rate of burning of mixtures of ammonium nitrate with polymers at a pressure of 1000 lb/in² (*ca.* 67 kg/cm²) at 60°F (*ca.* 15°C) ranges within 0.21–0.36 cm/sec.

VARIOUS COMPOSITE PROPELLANTS AND THEIR CHARACTERISTICS

Napoly [27] collected the information on various composite propellants. They are given in Table 90.

TABLE 90
CHARACTERISTIC OF SOME COMPOSITE PROPELLANTS [27]

Oxidizer	NH ₄ ClO ₄	NH ₄ NO ₃	NH ₄ ClO ₄	NH ₄ ClO ₄	NH ₄ ClO ₄	NH ₄ ClO ₄
Combustible binder	Polybutadiene	Cellulose acetate	Polyurethane	Polyurethane	Polyester	Polyvinyl chloride
Burning under pressure (kg/cm ²)	1–140	1–140	1–140	14–125	30–140	1–120
Specific impulse I_s at $p=70$ kg/cm ²	250	171	238	236	178	225
Rate of burning (mm/sec) under pressure $p=70$ kg/cm ²	11.9	2.2	5.8	12.2	17.5	6.5–13.5
Exponent n in the equation $V=kp^n$	0.236	0.50	0.5	0.479	0.69	0.4
Density	1.74	1.55	1.72	1.74	1.88	1.64

The same author [27] gives some data on a propellant which is intermediate between composite and double base propellants. It is composed of ammonium perchlorate and a nitroglycerine–nitrocellulose powder (double base powder).

It gives a very high specific impulse $I_s=250$ –255 (at 70 kg/cm²), and has a high rate of burning: 17.3 mm/sec (at the same pressure), exponent $n=0.45$ and density 1.75.

MIXTURES WITH AMMONIUM PICRATE

During World War II mixtures were developed in Great Britain with ammonium picrate as the chief component for rocket propulsion, on the suggestion of the author of the present book. These mixtures also contained sodium or potassium nitrate and a combustible binder.

Similar mixtures were adopted in the United States. Zaehring [6] quotes the following two compositions (Table 91).

TABLE 91
COMPOSITION OF AMMONIUM PICRATE PROPELLANTS

Ingredients	Name	
	NDRC Type EJA 218 B	NDRC Type EJA 480
Ammonium picrate	46.6	46.4
Sodium nitrate	46.6	46.4
Buramine resin*	5.2	—
Ethyl cellulose-arochlor**	—	7.2
Santicizer 8***	1.6	—

* Thermosetting urea or melamine resin.

** Arochlor—chlorinated diphenyl.

*** A plasticizer.

Rühl [28] has recently reviewed the patent literature on solid rocket propellants.

EXPLOSIVE PROPERTIES OF COMPOSITE PROPELLANTS

Composite propellants with elastomers (thiokol, polyurethane) do not detonate readily and this is due to their non-porous texture [29].

Most of the cast propellants' charges also possess very high density and thanks to this they are difficult to detonate (e.g. Price and Jaffe [30]). They are prone to detonation when they are shredded and put into vessels of high degree of confinement [31].

LITERATURE

1. E. MISHUCK and L. T. CARLETON, *Ind. Eng. Chem.* **52**, 755 (1960).
2. R. F. CHAIKEN, *Combustion and Flame* **3**, 285 (1959).
3. W. H. ANDERSEN, K. W. BILLS, E. MISHUCK, G. MOE and R. D. SCHULTZ, *Combustion and Flame* **3**, 301 (1959).
4. W. R. MAXWELL and G. H. S. YOUNG, *J. Roy. Aeron. Soc.* **65**, 252 (1961).
5. F. A. WARREN, *Rocket Propellants*, Reinhold, New York, 1958.
6. A. J. ZAEHRINGER, *Solid Propellant Rockets*, American Rocket Co., Wyandotte, 1955.

7. T. L. SMITH, *Ind. Eng. Chem.* **52**, 776 (1960).
8. R. T. LANDEL and T. L. SMITH, *J. Am. Rocket Soc.* **31**, 599 (1961).
9. Thiokol Chemical Corporation, Trenton 7, New Jersey, *Liquid Polymer LP-31 and Liquid Polymers LP-2 and LP-32*.
10. G. GÖBEL, *Kunststoffe* **49**, 56 (1959).
11. P. R. DYKSTRA, *Thiokol Astronaut* **3**, No. 2, 5 (1961).
12. J. C. CHAPMAN, *Thiokol Astronaut* **1**, No. 1, 3 (1959).
13. C. HUGGETT, Combustion of Solid Propellants, Section M in *Combustion Processes*, Ed. B. LEWIS, R. N. PEASE and H. S. TAYLOR, Princeton University Press, Princeton, N.Y., 1956.
14. *Thiokol Astronaut* **3**, No. 1, 20 (1961).
15. H. E. MARSCH, Jr., *Ind. Eng. Chem.* **52**, 768 (1960).
16. W. J. MURBACH and A. ADICOFF, *Ind. Eng. Chem.* **52**, 772 (1960).
17. Z. ALTERMAN and A. KATCHALSKY, *Bull. Res. Israel* **5A**, 46 (1955).
18. J. GRODZINSKI, *J. Appl. Chem.* **8**, 523 (1958).
19. S. GORDON and C. CAMPBELL, *Vth Symposium on Combustion*, p. 277, Reinhold, New York, 1955.
20. *Chemical & Engineering News* **42**, Sept. 28, 50 (1964).
21. J. TAYLOR and I.C.I. Ltd., Brit. Pat. 453210 (1936); U.S. Pat. 2159234 (1939).
22. J. TAYLOR and G. P. SILLITTO, *IIIrd Symposium on Combustion*, p. 572, Williams & Wilkins, Baltimore, 1949.
23. C. F. DOUGHERTY, *Chemical & Engineering News* **35**, No. 40, 62 (1957).
24. A. O. DEKKER and G. A. ZIMMERMAN, *Ind. Eng. Chem., Products Res. and Dev.* **1**, 23 (1962).
25. B. F. GREEK, C. F. DOUGHERTY and W. J. MUNDY, *Ind. Eng. Chem.* **52**, 974 (1960).
26. *Chemical & Engineering News* **42**, Oct. 5, 48 (1964).
27. C. NAPOLY, *Mém. poudres* **41**, 331 (1959).
28. G. RÜHL, *Explosivstoffe* **13**, 8 (1965).
29. A. B. AMSTER, E. C. NOONAN and G. J. BRYAN, *J. Am. Rocket Soc.* **30**, 960 (1960).
30. D. PRICE and I. JAFFE, *J. Am. Rocket Soc.* **31**, 595 (1961).
31. Bureau of Mines Annual Rep. No. 3647 (1957); Bureau of Mines Final Summary Rep. No. 3734 (1958); Bureau of Mines Annual Rep. No. 3769 (1959); Bureau of Mines Quarterly Rep. January 1 to March 31 (1961).

CHAPTER V

MINING EXPLOSIVES

BLACKPOWDER is a weak explosive, too slow in action to be an effective blasting agent. Attempts have therefore been made to replace it by a more powerful explosive (e.g. to substitute potassium chlorate for potassium nitrate). At first, however, this produced nothing of value. It was not until the second half of the nineteenth century when nitroglycerine had been produced that new prospects of improvement emerged. The fact that nitroglycerine is a more powerful explosive than blackpowder was perceived at once, although how this property could be exploited fully was not immediately clear. Both blackpowder and nitroglycerine were fired with a fuse. A blackpowder primer was used with nitroglycerine. In both cases the explosives were ignited and then, since they were burning in a confined space explosion, but not detonation, occurred. Yet nitroglycerine is a typical explosive capable of detonation. Thus the potential energy released by the detonation of nitroglycerine was not utilized. The proper exploitation of nitroglycerine as an explosive became possible only when detonators filled with mercury fulminate were introduced (1867).

Nobel's use of kieselguhr to produce dynamite [1] (Vol. II, p. 33) was a milestone since nitroglycerine thus acquired a solid form easy to handle. Guhr dynamite, however, failed to utilize fully the explosive power of nitroglycerine due to the presence of a large proportion (25%) of the inert material kieselguhr. The discovery of blasting gelatine [2] and of dynamites containing blasting gelatine as a chief ingredient was a step forward in improving mining explosives.

Another advance in this field was the use of ammonium nitrate as a chief component. In 1867 Ohlsson and Norrbin [3] patented a mining explosive—Ammoniakkrut (ammonium powder, cf. p. 331) consisting of ammonium nitrate mixed with 5–10% charcoal. Ohlsson and Norrbin added to this mixture 10–30% nitroglycerine to make detonation easier and to increase the power of the explosive. Similarly Nobel began to add ammonium nitrate to his dynamites.

The largest application of explosives is now in coal mines. They are also widely used in mining ores, in quarrying, for many civil engineering works such as road building, tunnel driving, land reclamation, canal construction, and changing the course of rivers—even for extinguishing fires (e.g. conflagrations of oil wells). In recent years large quantities of explosives have also been employed in seismographic prospecting for new oil fields.

When shotfiring in mines, quarries, rock blasting, the demolition of old buildings etc. the first step is to bore a cylindrical shothole. The hole is loaded with one or more blasting cartridges (usually a cartridge is 100 g in weight and 30 mm dia.). The first cartridge is fitted with a detonating cap or an electric detonator (in coal mines charges are fired only by electric detonators), and the shothole sealed with stemming material, commonly moist clay.

An explosive intended for use in coal mines must be safe to handle and to operate in the presence of material as ignitable as coal. Moreover to produce good lump coal slow-acting explosives should be employed which displace rather than fragment the coal. Conversely, in rock blasting greater explosive power is needed; the safety factor is less important.

RESEARCH ON THE SAFETY OF MINING EXPLOSIVES

The increasing use of explosives in mining greatly increased coal output but numerous gas explosions occurred in mines where blackpowder was used. The development of nitroglycerine and more modern explosive compositions did not eliminate this hazard. As the industry developed and the demand for coal increased the safety of explosives used in mines become so urgent and important a problem that in the nineteenth century many countries set up special commissions charged with its detailed analysis.

Although firedamp explosions in mines were notified as early as the seventeenth century in the oldest scientific establishments—the Academy of Paris and the Royal Society of London—the scientific and technical world in general was little concerned with them. But in 1812 an explosion at Branding Main near Gateshead-on-Tyne in England in which ninety-two miners were killed was given great publicity. The disaster led to the formation in 1813 of “The Sunderland Society” for preventing accidents in coal mines. The Society succeeded in persuading Sir Humphrey Davy to interest himself in the problem and in 1815 he devised the well known safety lamp. In 1849 a further step was taken in Great Britain with the passing of an Act for the Inspection of Coal Mines in Great Britain from which the modern era in coal mining really began (cited by J. Taylor and Gay [4]). In 1877 the Commission de Grisou was formed in France. Work began on the elucidation of the conditions under which mixtures of air and methane explode (Mallard and Le Chatelier [5]). It turned out that these mixtures explode at 650°C after a certain induction period which, at this temperature, is 10 sec. At a higher temperature it is shorter (e.g. at 1000°C it is approximately 1 sec). Although the temperature of explosion of any explosive is considerably above 650°C, the gaseous products of explosion cool rapidly due to expansion, and furthermore a large amount of the heat of explosion is converted into mechanical work on bursting the walls of the shothole. Thus, the explosion of a high explosive does not necessarily produce a temperature at which a mixture of air and methane will explode.

The duration of the flame produced by the explosion is another important factor. The flame of a high explosive is of extremely short duration and may not be sufficient to ignite firedamp. Conversely the flame produced by burning blackpowder lasts much longer and is therefore more dangerous. Clearly, the duration and temperature of the flame of explosion are the factors which determine the safety of an explosive used in mines.

On the basis of many experiments the Commission de Grisou and later, the Commission de Substances Explosives headed by M. Berthelot and Le Chatelier introduced, in 1890, the following safety rules for the use of explosives in coal mines [6]:

1. On explosion the explosive must not leave any combustible products such as CO, H₂, carbon.

2. The detonation temperature computed from the heat of explosion and from the average specific heat of the products must not exceed 1900°C for explosives intended for penetrating rock and 1500°C for those to be used in coal mines.

On these grounds blackpowder was excluded from coal-mining works, for it is an explosive that leaves a combustible residue and has a very high explosion temperature (approximately 2400°C).

The theoretical calculation of the detonation temperature as a safety criterion was adopted only in France. In all other countries (and more recently also in France) a practical criterion has been introduced based on an experimental evaluation of the effect of explosion of a sample of the explosive on a mixture of air and methane, or on a suspension of coal-dust in air, under conditions similar to those existing in mines. For this purpose testing galleries were devised, simulating the conditions of mine galleries.

A typical one (Fig. 149, p. 441) consists of a cylindrical or elliptical tube made of wrought iron. At one end the tube is closed with a thick plate simulating the coal face. It is provided with a steel mortar, which imitates the shothole. A section of the gallery containing the mortar loaded with an explosive charge is separated by a paper diaphragm from the remainder to form an explosion chamber which is then filled with a defined amount of methane. The explosive charge is fired electrically with a No. 8 detonator. The course of the explosion is watched through the observation holes along the gallery.

The first testing gallery was built in Germany, at Gelsenkirchen in 1880. It was a tube of elliptic cross section of 2 m², 35 m long. Next, about 1890 another testing gallery was built in Great Britain, at Hebburn-upon-Tyne, by The North of England Institute of Mining and Mechanical Engineers. It consisted of a wrought-iron tube, 101 ft long and 3 ft dia., with a paper diaphragm 22½ ft from the closed end forming an explosion chamber. The 1½ in. dia. mortar was 42 in. long, the explosive being fired both stemmed and unstemmed (according to J. Taylor and Gay [4]).

The important conclusion drawn from investigations with this gallery was that high explosives were less liable than blackpowder to ignite an inflammable mixture of air-methane and coal-dust.

Another testing gallery was built in Great Britain at the beginning of this century

at Althofts by the Mining Association of Great Britain [7]. It was over 200 m long, 2.30 m dia. and served mainly for testing the explosibility of coal-dust and methods of preventing it (such as stone-dust, stemming with sodium hydrogen carbonate, etc.).

A Home Office Testing Gallery Committee was appointed in 1896. The Committee's aim was to establish the best test for determining the safety of explosives in coal mines. On its recommendation a testing station was erected at Woolwich and the testing of explosives for inclusion in the "Permitted List" began in 1897. The testing gallery was $27\frac{1}{2}$ ft long and $2\frac{1}{2}$ ft dia. and was filled with an inflammable medium: (15% coal gas + 85% air). The steel mortar had a bore of $1\frac{3}{4}$ in. dia.

The charges were stemmed with dry clay.

The Home Office testing station was transferred to Rotherham in 1911 and a new gallery was erected. It was 5 ft dia., with an explosion chamber 18 ft long. The steel mortar was 120 cm long with a 55 mm bore.

In 1921, difficulties with the supply of coal-gas at Rotherham led to the temporary transfer of testing to Ardeer and eventually a new Research Station was established at Buxton in 1922.

In Belgium the official testing gallery was erected at Frameries under direction of Watteyne and Stassart in 1902. It was of elliptical cross section (1.85 m/1.40 m), 85 m long.

In France two testing galleries were built at Liévin in 1907. Both were cylindrical. One of 2 m² cross section and 15 m long was used for testing explosives. Another one of 2.80 m² section was 300 m long and was used for examining coal-dust explosion and methods of preventing it. In Austria-Hungary two galleries came into use in 1908.

In the U.S.A. a cylindrical gallery of 6 ft 4 in. dia. and 100 ft long was built 1909 in Pittsburgh.

Modern testing galleries are described later (p. 439 and Table 108).

In addition to the experiments in testing galleries laboratory research has also been conducted, including a study of the flames produced by explosives when exploded. These flames have been studied photographically to determine their dimensions, intensity and duration. The following papers are noteworthy: Siersch [8], Bichel and Mettengang [9], Wilkoszewski [10], Will [11], Taffanel and Dautriche [12].

When observing the flame projected from the mortar of a testing gallery Lemaire [13], Payman [14] and Audibert [15] came to the conclusion that the ignition of air-methane mixtures may also be caused by glowing particles formed on explosion and thrown out of the shothole.

On the basis of flame studies, explosives may be divided into two principal groups:

(1) Explosives with a secondary flame which have not enough oxygen for complete combustion. On the detonation of these materials combustible products are formed such as CO, H₂, CH₄ etc. These products become mixed * with air, producing

* Oxygen-positive explosives may also produce combustible products, although in negligible quantity. The amount of such products is greater on detonation in the open.

combustible gaseous mixtures which explode in turn giving rise to a bright secondary flame (Fig. 127). Trinitrotoluene, picric acid and guncotton belong to this group. Blackpowder which does not detonate but only explodes also gives a secondary flame.



FIG. 127. Flame from picric acid. The primary flame (relatively small) is visible with the secondary flame above it. The duration of both flames is shown on the scale: the primary flame of short duration, the secondary of long duration. The material was fired in a mortar (according to Will [11]).

(2) Explosives with a primary flame only. This group comprises all mixtures containing more than enough oxidizing agents to provide a positive oxygen balance. They differ from each other in flame intensity. Rock explosives (e.g. dynamites, i.e. explosives with nitroglycerine) give a glaring flame of high-temperature and relatively long duration (Figs. 128 and 129). Permitted Explosives* give a faint, low-temperature flame of short duration (Fig. 130).

* English term for coal-mining explosives which have passed special tests as explosives assuring a sufficient safety for use in coal mines where inflammable mixtures of methane and air occur. In the U.S.A. they are called permissible explosives.

As a result of these investigations, group (1) explosives were withdrawn from use in coal-mines. The duration of the secondary flame is rather long so that the gaseous mixture ignites easily.

Rock-blasting explosives of group (2) have a very high temperature of explosion. Among these dynamites have been permitted exclusively for work in rock and in non-fiery mines.

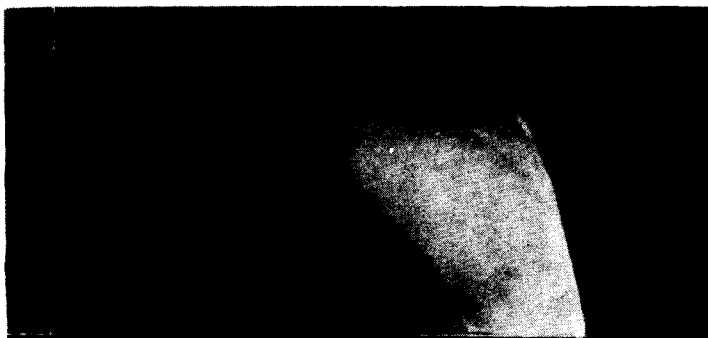

FIG. 128. Flame from Dynamite I (61–63% nitroglycerine). Duration 7.66 millisecc. The material was fired in a mortar (according to Bichel [16]).



FIG. 129. Flame from dynamite having a low nitroglycerine content (Gelatine-Dynamite). Duration 1.25 millisecc (according to Bichel [16]).

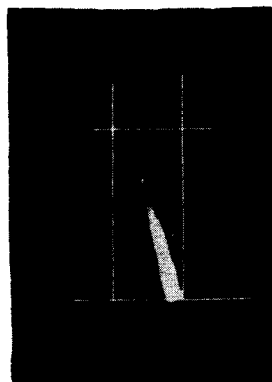

FIG. 130. Flame from ammonium nitrate explosive (Ammoncarbonit). Duration 0.33 millisecc (according to Bichel [16]).

The ammonium nitrate explosives of the same group may be fired without igniting a methane–air mixture even when relatively large charges are used whereas other explosives ignite the gas mixture unless used in small amounts. Thus arose the concept of the maximum charge that can be fired without causing the ignition of a definite methane–air mixture in a testing gallery. This is called the “charge limit”. This made clear that apart from the temperature of the flame of explosion (calculated from the heat of reaction and the mean specific heat of the products) there

are other agents which may provoke an explosion. One factor that increases the danger is a very high rate of detonation and "specific pressure" for lead block expansion. The shock-wave produced by the detonation may involve a rapid, almost adiabatic compression of the methane-air mixture. The higher the rate of detonation, the greater is such compression and, in consequence, the probability of explosion of the gas mixture. In addition, when the energy of the explosion of a charge is transformed into work only to a small extent, it may happen that the shock-wave thus produced involves the adiabatic compression of the gas mixture referred to. This means that it is dangerous to load shotholes with a larger amount of explosive than is necessary for the work in hand. The unused surplus of energy may cause an accident since a large quantity of heat is not transformed into work and the products of detonation then have a higher temperature. This proves the necessity of strict observance of the maximum safety charge (charge limit). However, the concept of charge limit was recently subjected to revision (see p. 413).

Superficially, this seems to contradict the rule that the use of explosives which do not detonate but only explode (or burn) like blackpowder, as mentioned above, is unsafe, but in fact this is not so. The point is that both non-detonating explosives with a flame of long duration (like blackpowder) and those marked by high rate of detonation producing a violent shock-wave are unsafe. The safest explosives are those with intermediate properties, i.e., which give a not very high rate of detonation and lead block expansion, but in which the reaction of explosive decomposition proceeds much more quickly than in blackpowder, which burns or explodes relatively slowly.

These investigations showed that no modification of blackpowder by the addition of "cooling salts", i.e., those that reduce the flame temperature (e.g. oxalates) will improve its safety. On the other hand, the presence in dynamites of 35-63% of inert (non-explosive) salts, such as sodium hydrogen carbonate, ammonium oxalate, or salts containing crystallization water, increases their safety not only by lowering the temperature of the flame of explosion but also by reducing their explosive power. Chlorides of alkali metals, such as potassium and sodium, are particularly efficient in this respect.

It was also found that mixtures containing a large amount of ammonium nitrate (ammonium nitrate explosives) ensure much greater safety than dynamites or chlorate and perchlorate explosives.

Early in the present century attention was drawn to the danger created in mines by coal-dust. Until 1906 it was believed in France that this hazard could be entirely explained by the presence of firedamp, but even in the early nineteenth century it was supposed that a suspension of coal-dust in the air may also explode. Thus, as early as 1803, it was suggested in the U.S.A. that coal-dust might be involved in mine explosions [17]. In 1844, Faraday drew attention to this (according to J. Taylor and Gay [4]), and later Galloway [18] discussed the coal-dust danger. By the end of the last century the possibility of explosion was proved experimentally, but it was believed that an explosion of methane-air mixture is necessary to initiate a coal-

dust explosion and that conditions were safe if there was no methane in the atmosphere.

At the turn of the nineteenth century, explosions occurred in Great Britain, in non-fiery mines, proving the possibility of an explosion of coal-dust without methane as an initiating agent. It was however insufficient to rouse the experts to action.

Meanwhile, in 1906, a terrible coal-dust explosion occurred at Courrière in France, in which about 1100 men lost their lives. The mine at Courrière had no methane at all and was considered to be safe, but as it turned out, it contained coal which in dust form produced a very dangerous suspension. The vast extent of this disaster aroused public indignation. It became obvious that the explosion of coal-dust may extend over a large area under ground and that this is much more dangerous than the explosion of methane which is usually localized within a small area.

It was also obvious that the immediate cause of explosion of both methane and coal-dust may be the use of explosives in mines. Particular attention was paid to the hazard involved in the use of blackpowder in mines (e.g. in Great Britain H.M. Commissioners [19]; Royal Commission on Explosions [20]).

Attempts were made to reduce the danger in the use of blackpowder by surrounding the charge with a water sheath (Abel [21]), but this method was abandoned as it was very troublesome in practice. Recently it has been revived in an improved form (p. 489).

Another method was to dip blackpowder pellets in paraffin wax. This rendered them waterproof, and also surrounded them with a "cooling sheath". A blasting powder made in this form called "Bobbinite" was introduced in Great Britain. It will be discussed later. These half-measures brought little improvement and attention was centred on the use of ammonium nitrate explosives.

After the explosion at Courrière experiments were carried out in testing galleries on blasting explosives and on suspensions of coal-dust in air. As the coal-dust from various mines showed different inflammability, the most inflammable kind, i.e., that with a high content of volatile matter, was commonly used for testing.

The explosion of coal-dust is usually of a thermal character. It undergoes degasification under the influence of a high temperature to form coke grains. If such grains are found after an underground explosion it is proof that the explosion was due to coal-dust.

It should however be pointed out that the principal source of colliery accidents is not explosion but roof falls. Rogers [22] gives the following annual figures for 1923-59 in Great Britain (Table 92):

TABLE 92

	1923-32	1933-42	1943-52	1953-59
Roof falls	500	450	250	166
Haulage	250	170	110	95
Explosions and fires	50	90	50	30
Shafts	40	20	20	15

SAFETY EXPLOSIVES BEFORE WORLD WAR I

Certain types of safety explosives were designed on the basis of a number of tests, although until recently there were considerable differences in the composition of these explosives in different countries. This was due to different working conditions in mines, different methods for testing the safety of explosives etc.

After World War II some standardization in composition was achieved largely as the result of international cooperation. The annual International Conferences of Directors of Safety in Mines Research greatly contributed to this.

The first safety explosives produced in **France** are tabulated below:

TABLE 93
COMPOSITION OF EARLIEST FRENCH SAFETY EXPLOSIVES

Name	Ingredients (%)			
	Nitroglycerine	Nitrocellulose	Ammonium nitrate	Potassium nitrate
<i>For coal work</i>				
Grisoutine Couche	12	0.5	87.5	—
Grisoutine Couche au Salpêtre	12	0.5	82.5	5.0
<i>For rock work</i>				
Grisoutine Roche	29.0	1.0	70.0	—
Grisoutine Roche au Salpêtre	29.0	1.0	65.0	5.0

These explosives are characterized by an absence of "cooling substances" even when intended for use in coal mining. In a number of countries they were considered dangerous.

The same explosives were formerly employed in **Russia**, where the mining explosives industry was financed by French capital. In both countries Favier Powders (Poudres Favier) or Favier explosives (Explosifs Favier) were also employed. Their composition is tabulated below.

TABLE 94
COMPOSITION OF FAVIER EXPLOSIVES

Favier Explosive	Ingredients (%)			
	Ammonium nitrate	Sodium nitrate	Nitronaphthalene	Dinitronaphthalene
1A	88	—	—	12
1B	67	18	15	—
2	44	37.5	18.5	—
B	—	75	25	—

Chlorate explosives were also used in both countries, in mines, viz.: Miedziankit type in Russia (p. 278) and Cheddite type in France (p. 277).

In **Belgium**, at first explosives modelled on the French ones were used, but later they were replaced by others containing "cooling" ingredients, such as ammonium chloride, sulphate, or oxalate or sodium chloride. The safety explosives used initially in Belgium included mixtures with ammonium perchlorate, of the Yonckite type. Examples of these explosives for rock and coal work are given in Table 95.

TABLE 95
COMPOSITION OF SOME BELGIAN SAFETY PERCHLORATE EXPLOSIVES

Ingredients (%)	Yonckite type, brisant No. 13 (roche)	Yonckite type antigrisouteuse No. 10 bis (couche)
Ammonium perchlorate	20	25
Ammonium nitrate	27	30
Sodium nitrate	27	15
Barium nitrate	6	—
TNT	20	10
Sodium chloride	—	20

In **Great Britain** the first explosives which passed the test in the testing gallery at Woolwich were approved for use in mines under the name of *Permitted Explosives*. At Woolwich the charge of explosive in the test mortar was stemmed with dry clay, a practice that differed from that followed in other countries.

On the basis of these tests the following substances were considered safe and were used in mines.

(1) Bobbinit—an explosive having virtually the composition of blackpowder but with the flame temperature of explosion reduced by the addition of salts or a mixture of paraffin with starch.

(2) Saxonite—dynamite, made safe by the addition of about 13% ammonium oxalate.

(3) Monobel—an ammonium nitrate explosive containing about 80% ammonium nitrate and 10% nitroglycerine, plus 10% wood meal which adsorbed the nitroglycerine.

(4) Faversham Powder—another type of ammonium nitrate explosive, without nitroglycerine, containing, for instance, 90% ammonium nitrate and 10% TNT.

(5) Cambrite—an ammonium nitrate explosive modelled on the German "Carbonits" (see Table 124). It contained a small quantity of nitroglycerine, potassium or sodium nitrate and a considerable amount of carbonaceous material (e.g. wood meal, charcoal etc.). This material was added to prevent the complete combustion of the carbon included in the explosive (to carbon monoxide only), to reduce the heat of explosion and, in consequence, the temperature of the explosion.

Bobbinit and some of the other explosives permitted for use in mines caused, however, a number of explosions of firedamp and coal-dust, and it was decided therefore to adopt a more exacting form of test. In 1912, the Rotherham test was

introduced. In this the explosive charge was fired unstemmed, as in the Continental test. At the same time the charge limit was determined. These tests led to the exclusion of Bobbinite from the Permitted List (except in some experimental mines) and to a considerable reduction of power of all the permitted explosives, by the addition of cooling substances such as sodium chloride, ammonium oxalate etc. In this way mining explosives having the composition presented in Table 96 were evolved.

TABLE 96
EARLIEST BRITISH PERMITTED EXPLOSIVES

Ingredients	Ammonite	No. 1 Bellite	No. 3 Dynobel	No. 2 Cambrite	No. 3 Samsomite	No. 2 Viking Powder	Tees Powder
Nitroglycerine	-	-	14-16	22-24	50.5-52.5	7.5-9.5	9-11
Nitrocellulose	-	-	0.25-0.75	-	2-4	-	-
Dinitronaphthalene	4.5-6.5	-	-	-	-	-	-
Dinitrobenzene	-	-	-	-	0-0.5	-	-
DNT	-	-	0.5-2.5	-	-	-	-
TNT	-	14-16	-	-	-	-	-
Ammonium nitrate	71-75	62-65	51-54	-	-	65-69	58.5-61.5
Sodium nitrate	-	-	-	-	9-11	-	-
Potassium nitrate	-	-	-	26-29	-	-	-
Barium nitrate	-	-	-	3-4.5	-	-	-
Woodmeal	-	-	4-6	32-35	-	7-9	8-10
Starch	-	3.5-5.5	-	-	-	-	-
Potassium chloride	-	-	-	7-9	-	-	-
Sodium chloride	20-22	15.5-17.5	24-26	-	9-11	14-16	19-21
Borax	-	-	-	-	24-26	-	-
Magnesium carbonate	-	-	1.0	-	-	0.5-1.0	-
Moisture	0-1	0-2	0-2	3.5-6	0-1.5	0-2	0-2

Chlorate explosives, such as Colliery Steelite, which were used for a short time in coal mines, had the following composition:

72.5-75.5% of potassium chlorate
23.5-26.5% of nitrated resin
0.5-1.5% of castor oil

They were also removed from the Permitted List.

In **Austria** explosives similar to those of the French Favier type were permitted for use in mines.

In **Germany**, slow-action (non detonating) explosives of the blackpowder type (blasting powder, black blasting powder—see Table 78) were used even in dusty mines up to 1923 and typical high explosives (1910) with the composition given in Table 97, were also employed.

The explosives which did not contain cooling salts belonged to the carbonite or donarit groups and were intended for work in rock or in non-dusty and non-

gassy coal mines. Those containing cooling salts (Wettersprengstoffe) were used for work in more dangerous coal mines. The composition of the Gelatine Wetter-Astralit explosive in which dinitrochlorohydrin was added to nitroglycerine to form an antifreezing mixture is particularly noteworthy.

TABLE 97
EARLY GERMAN SAFETY EXPLOSIVES

Ingredients	Donarit	Wetter-Astralit	Chrome Ammonit	Ammon Carbonit	Gelatine Wetter-Astralit
Nitroglycerine	4	4	—	3.9	4
Dinitrochlorohydrin	—	—	—	—	16
Nitrocellulose	—	—	—	0.1	0.5
Nitrotoluene	—	—	—	—	1
DNT	—	—	—	—	4
TNT	12	7	12.5	—	—
Ammonium nitrate	80	74.5	70	82	40
Potassium nitrate	—	—	10	10	—
Sodium nitrate	—	—	—	—	7.5
Flour	—	—	—	4	8
Woodmeal	4	1	—	—	—
Charcoal	—	1	—	—	0.5
Vaseline or paraffin	—	2.5	0.5	—	—
Castor oil	—	—	—	—	2
Chromium-potassium alum	—	—	7	—	—
Ammonium oxalate	—	—	—	—	2.5
Sodium chloride	—	10	—	—	14

CONDITIONS OF SHOTFIRING IN MINES

As knowledge of the danger created by the use of explosives in coal mines grew, attempts were made to obtain new, more suitable explosives and to work out the safest possible methods for their use, including shotfiring methods. Strict regulations were laid down for charging shotholes, stemming (governing the type of stemming materials, length of stemming etc.), firing charges etc. Wherever danger existed, due to the presence of methane or coal-dust, electric detonators replaced fuses which, if defective, might spark through the sheaths. Detailed instructions were also evolved for firing procedure. Simultaneous firing of the charges in several shotholes (shotfiring in rounds) was found to be safer than firing in sequence, when one shot might raise a "cloud" of coal-dust which then might be exploded by the following shot. On the other hand the use of electric detonators with a delay-fuse increases output since the early shots can create free faces facilitating the work of the following shots. It is, therefore, not surprising that short-delay detonators are now in wide use, very often in combination with shotfiring in rounds of 2-6 shots. Research is still

under way to ascertain whether when using short-delay detonators there is in danger of ignition from the possibility that one shot might cause conditions dangerous for another. The risk may arise due to the opening of fissures that release firedamp and, as previously described, due to raising a cloud of coal-dust before the last shot in the round is fired. Some authors concluded that under experimental conditions ignition only occurs when the interval between successive shots exceeds 70 milli-sec and it was therefore concluded that the usual short delay of 25 millise-sec should be considered safe (Fripiat [23]).

Entirely new safeguards were also introduced to avert danger. When it was found that coal-dust may explode it was suggested that the cartridges would be stemmed by filling them with water (MacNab [24]) or with a porous mass mixed with water. The water, dispersed by the detonation, forms a cloud that may reduce the probability of explosion. Stemming with incombustible substances in powder form was also tried. On detonation, such stemming was intended to form an air suspension that would prevent explosion of the coal-dust. Cybulski [25], however, proved the inefficiency of this method by showing that stemming with dust does not produce a cloud capable of providing protection against explosion. In addition, a powder stemming is ejected more quickly from the shothole than one made of clay.

Watteyne and Lemaire [26] recommended that outside the shothole, or strictly speaking outside the stemming, a paper bag should be placed, containing an incombustible material, such as ground sand, salts containing water of crystallization (e.g. sodium sulphate), salts volatile at a high temperature (e.g. sodium chloride), or salts decomposing at a high temperature (e.g. ammonium sulphate). This was later developed by Lemaire into the use of a sheath of inert substance around the cartridges (see p. 429).

Numerous tests indicated the factors that influence the results of shotfiring and showed, in particular, that variations in results are caused by changes in the composition of the methane-air mixture (e.g. when gas produced by coal carbonization, which is liable to variations in composition, or natural gas which varies in composition depending on its origin, was used for testing instead of pure methane). This emphasized the need to use a test gas of constant composition.

It was also found that the coal-dust in the presence of which explosives were tested, varied in ignitability; to achieve comparable results therefore coal-dust from the same seam of the same mine must be used. If the same explosive is always used, the ignitability of coal-dust in a given mine may be tested to determine to what extent work in the mine is dangerous. It is obvious that changes of atmospheric humidity also affect the results.

Numerous tests were also carried out to examine other, less tangible factors which affect the accuracy and reproducibility of the results obtained in a testing gallery. The following factors were found to be of importance:

- (1) The density of loading of the shothole (greater density facilitates ignition of methane or dust);

(2) The diameter of the explosive charge (larger diameter favours easier ignition);

(3) The shape and surface area of the testing gallery (elliptical shape and smaller surface favour easier ignition);

(4) The wrapping of the explosive charge, e.g. paraffined paper, parchment paper, tinfoil etc. (this factor was tested over a long period and some of the results are discussed further on p. 424).

MINING EXPLOSIVES USED DURING WORLD WAR I

In World War I the belligerents reserved nitric acid and its salts for military purposes. The mining industry could obtain only small amounts of ammonium nitrate and other salts of nitric acid, and therefore had to employ other oxidizing agents.

For blasting rock and for work in non-gassy and non-dusty coal mines, chlorate explosives were widely used, e.g. Miedziankit in Russia and Germany, Cheddites in France. In Belgium and Germany perchlorate rock explosives were also in general use: in Belgium, ammonium perchlorate (Yonckites), in Germany, potassium perchlorate (the composition of these explosives differs slightly from those included in Table 121, which were introduced immediately after World War I). During the war an explosive "Blastin" was used in Great Britain for rock work. It consisted of:

Ammonium perchlorate	60%
Sodium nitrate	22%
TNT	11%
Paraffin	7%

For coal work, especially in gassy and dusty mines a safety perchlorate explosive with the composition tabulated below (Table 98) was manufactured in Germany.

TABLE 98
GERMAN SAFETY PERCHLORATE EXPLOSIVES

Ingredients	Wetter Permonit	Wetter Persalit	Wetter Perchlorit 4	Neuleonit II
Potassium perchlorate	32.5	35	30	35
Ammonium nitrate	34.5	—	34	10
Sodium nitrate	—	31	—	3
DNT	—	25	10	11
TNT	7	—	—	—
Nitroglycerine	3	6	—	4
Flour	4	—	—	5
Woodmeal	3	3	3	2
Glue solution in glycerine (1:7)	1	—	—	—
Charcoal	—	—	1	—
Sodium chloride	15	—	22	30

These mixtures, however, brought no new advantages and did not fully meet requirements with regard to safety in gassy and dusty mines, sensitiveness to impact and friction and mining efficiency. In addition, perchlorate explosives, like chlorate ones, have the defect that under certain conditions they do not detonate, but burn out in the shothole, which may lead to a catastrophic fire or explosion. Perchlorate explosives were then withdrawn from coal work after World War I and restricted exclusively to rock work. Japan seems to be the only country where some perchlorate explosives are accepted as "permitted explosives" (see p. 474).

RESEARCH AFTER WORLD WAR I

After 1918 research started before the war was continued intensively, by erecting further testing stations and extending the sphere of their activity. Table 108 shows the characteristics of the most important testing galleries in use between and after the wars as official testing stations. Here the new explosives are studied to determine their suitability for use of mines; safe methods of shotfiring are sought; and ways of preventing explosions of methane and coal-dust investigated. The classification of mines from the view point of coal-dust safety is also carried out at these testing stations. Testing galleries are also in operation at explosive factories. These are used to control the manufacture of explosives, and to test new safety explosives. Diagrams and descriptions of some galleries will be found in a later section (Table 108, p. 440).

The intensive, many-sided work of these testing stations contributed greatly towards overcoming the hazards of using explosives in mines. They led to the production of explosives possessing a high degree of safety and to the formulation of safety regulations laid down on the basis of long experience so that coal mining is little more hazardous than work in other branches of industry. The problem of the safe use of explosives in coal mines was developed into a new branch of applied science, which exceeds the scope of this book. Here only a few fundamentals will be given.

The flame of explosion. Experiments by Hiscock [27] and T. Urbański [28] showed that the flame of safety explosives in firedamp and coal-dust is very small and its intensity insignificant. These explosives, differed little in the dimensions and intensity of flame produced in these tests.

Audibert [29], Payman [30] and Beyling [31] studied the flame of explosives detonating in a steel mortar with or without stemming, and showed that a stemming 12 cm or so long is sufficient to quench a flame perceptible in a photograph. On shots fired without stemming the authors made a number of important observations:

- (1) In a shothole of definite depth with the detonator placed at the end of the charge facing the opening, the flame decreases with increasing charge.
- (2) With a constant explosive charge the flame increases with the depth of the shothole i.e. as the space between the charge and the opening increases.

(3) With a constant free space between the charge and the opening, the dimensions of the flame are independent of the size of the charge.

(4) The flame is increased by moving the detonator from the open end of the shothole to the bottom of the shothole.

No definite relationship has been found between the dimensions of the flame and the ability of the explosive to ignite the methane-air mixture. According to Beyling, for instance, if the detonator is situated at the open end of the shothole,

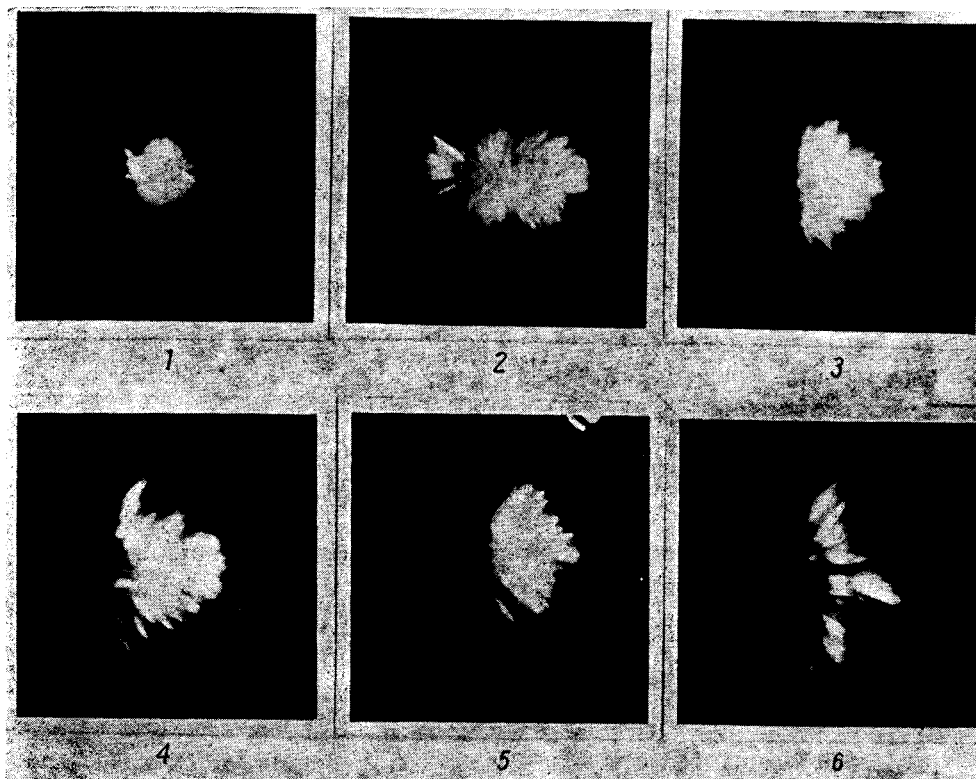

FIG. 131. Detonation flame of Metanit B, according to Cybulski [25]. Diameter 32 mm, charge 300 g, suspended in air. Time interval between the photographs 0.051 millisecc. Total duration of the flame 0.306 millisecc.

as is usual in shotfiring, no charges within the range 50–100 g ignites the gas provided that the free space between the charge and the opening lies within the limits 0–200 cm. It has also been found that a decrease in the free space decreases safety, creating a greater probability of explosion in spite of the decrease of flame (case 1).

Thus, Payman found that a smaller charge of ammonium nitrate explosive (No. 2 Viking Powder, see Table 96) is more likely to explode the gas mixture than a larger one. This would be compatible with observation 1; on the other hand, on moving the charge nearer to the mouth of the shothole the flame is removed almost com-

pletely, although, as Payman reports, this increases the chance of explosion, contrary to observation 1.

A detonator placed in the lower section of the charge is more likely to explode a methane-air mixture. This is attributable to the increase of flame, in accordance with observation 4.

Such contradictory test results show that the safety of explosive cannot be assessed solely in terms of the dimension of the explosion flame.

It is the opinion of many authors that high speed photographs of the flame should be supplemented by information about its position at a given moment in relation to the shock wave and the hot products of explosion.

Nevertheless examination of the flame on high-speed film makes an important contribution to the understanding of the properties of explosives and is often employed as an auxiliary test for the determination of the safety of explosives intended for use in mines.

The two sets of photographs illustrated were taken by Cybulski. Both refer to safety explosives used in Poland, viz., ammonium nitrate type Metanit B (Fig. 131) and nitroglycerine (dynamite) type, Barbaryt AGI (Fig. 132).

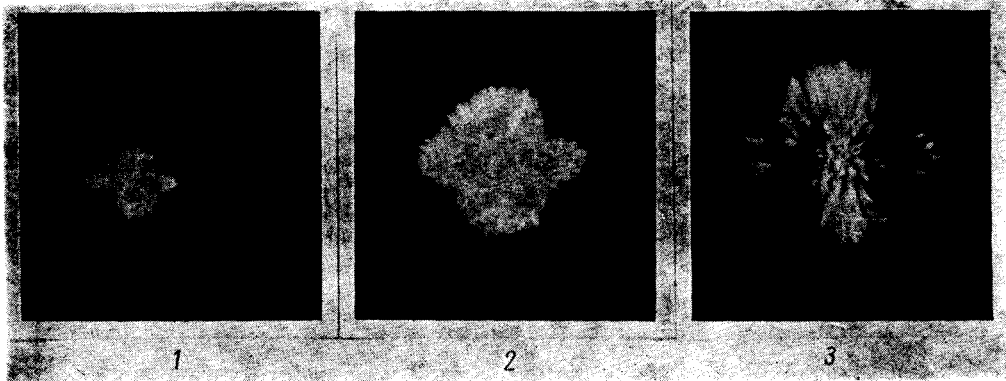

FIG. 132. Detonation flame of Barbaryt AGI, according to Cybulski [25]. Diameter 32 mm, charge 100 g, suspended in air. Time interval between the photographs 0.051 millisecc. Total duration of the flame 0.153 millisecc.

The effect of solid particles. In his studies of the detonation products of explosives stemmed in different ways, Audibert [29, 32] paid attention to the fact that in charges insufficiently stemmed a certain amount of the explosive remains in the form of small particles which may undergo further explosive decomposition according to conditions, i.e., temperature and ambient pressure. If these particles are ejected into a space filled with a methane-air mixture they may lead to the explosion of this mixture. The possibility of the existence of particles of undecomposed explosive in ejected detonation products has been disputed by some authors (Segay [33]), but many others have proved that it can occur. T. Urbański [34] found that a thin layer on the periphery of a cylindrical charge of ammonium nitrate explosive is

scattered by the explosion of the charge and does not explode. Beyling [31] showed that undetonated particles of ammonium nitrate explosive may cause ignition of the methane-air mixture in a testing gallery.

There is also a certain probability that fragments of the walls of a shothole ejected by detonation may join these unexploded particles. Further, it has been suggested that the remnants of a metallic detonator case cause ignition of methane-air mixtures. Payman's [14] photographic studies proved that the particles of a copper detonator case cannot provoke ignition. Being always surrounded by detonation products they cannot penetrate the shock wave created by the explosion products and come into contact with the methane-air mixture. Conversely, the particles of an aluminium detonator case may penetrate into the methane-air mixture through the shock wave. Hence the hazard in the use of aluminium cases, which has been confirmed frequently in practice. In addition, the very high heat of combustion of aluminium, giving high temperatures, must be taken into consideration as a factor liable to increase the probability of a methane explosion.

Shock wave. An early assumption, originally unsupported by direct experience, that the detonation of an explosive may involve the explosion of a methane-air mixture even when the detonation is not accompanied by a large, hot flame, has been confirmed experimentally. It was found that a mixture of 6.5% methane with air, for instance, may ignite under rapid compression by mechanical means up to 54 atm.

Perrott [35] ascertained photographically that on the detonation of an explosive in a methane-air mixture, the ignition of the latter starts at a spot not yet reached by the flame of detonation of the explosive. Thus, in all probability the ignition is caused by a shock wave travelling ahead of the flame.

Payman *et al.* [36, 37] showed the substantial validity of this observation. By a schlieren photographic method Payman found that the detonation wave has the same direction as the gaseous products when the detonator is situated at the bottom of the shothole. With this arrangement, the ejection of gases from the shothole is more intense, the velocity of the shock wave is higher and the probability that the methane-air mixture will ignite is also greater. If, on the other hand, the detonator is placed in the normal way, i.e. near to the stemming, the direction of the detonation wave is opposite to that of the gaseous products. The latter then form a sort of "gaseous stemming" around the detonator which holds back the shock wave and thus reduces the probability of explosion of the gas mixture.

Investigations into the shock wave arising on the detonation of an explosive as part of the problem of safety in the use of explosives attracted attention to the rate of detonation of mining explosives as a factor directly influencing the velocity of the shock wave. The earlier observation that a mining explosive, to be safe with methane, should be relatively weak, was thus confirmed. The reason why explosive charges with a large diameter are more dangerous than those with a small diameter also became clear. This is due to the higher rate of detonation of charges with a larger diameter.

GENERAL CONSIDERATION ON SAFETY OF EXPLOSIVES

From many tests carried out in testing galleries and from mining practice it has been shown that an explosive which is safe against methane, should have a rate of detonation of approximately 2000 m/sec at the given density and should give a lead block expansion not exceeding 200 cm³. In 1924 a special commission in Germany established a lead block figure of 235 cm³ at 15°C as the maximum value admissible for the explosives used for coal mining. This is now considered too high.

Dubnov [38] postulated the causes of the explosibility of methane by the detonation of an explosive. On being ejected from the shothole the products of detonation of an explosive charge are mixed with the air and the methane present in the atmosphere. The probability that the mixture will explode depends on the following factors:

(1) Time t , which elapses before the combustible ingredients achieve a concentration capable of being exploded.

(2) Induction period τ , which is necessary to bring about the explosion of this gaseous mixture at a given temperature.

Since after time t has been surpassed, the composition of the gaseous mixture tends towards a decreasing concentration of combustible ingredients while the temperature of the mixture falls, the safety condition is fulfilled when $\tau > t$.

Until recently the concept of a safe "charge limit" was regarded as one of the fundamentals in the use of explosives in coal mines. However, Cybulski's [39] investigations have shown that the thickness of the clay layer used as stemming is critical for the safety of the explosive, which is relatively little affected by the type of explosive. Also the charge weight seems to be unimportant according to these experiments. Therefore doubt arises as to whether the concept of charge limit, as a measure of safety of the explosives, is of real value. It appears that proper stemming is of greater significance.

Figure 133 shows the relationship between the safety of an explosive (expressed by a charge limit for the non-ignition of the methane-air mixture) and its power (expressed in per cent of the power of blasting gelatine), according to British investigations [4, 40]. Since the usual initiation near the mouth of the mortar does not give a sufficiently clear picture (the majority of safety explosives then fail to ignite methane), detonation was initiated at the back of the mortar. As the two curves show, there is a greater probability of the ignition of methane in a drift with a smaller diameter. It is obvious that the relationship between charge limit and power is comparable only for explosives of the same type (e.g. ammonium nitrate, gelatinous, semi-gelatinous etc.). The power of an explosive must not therefore be considered in the abstract, apart from its composition, and the above-mentioned view, that limitation of the rate of detonation is recommended, may be right only within definite limits governing the composition of the explosive and under definite experimental conditions. J. Taylor [41] reports the following experimental results:

Polar Ajax, a gelatinous explosive was fired as usual in the mortar of a testing

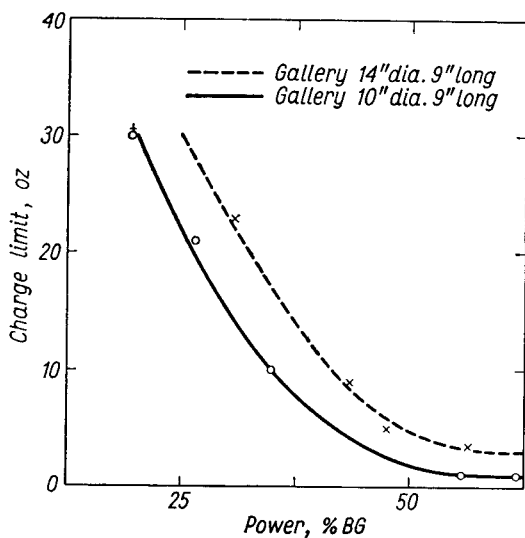

FIG. 133. Relationship between charge limit and power of explosives (J. Taylor and Gay [4]; Titman and Wilde [40]).

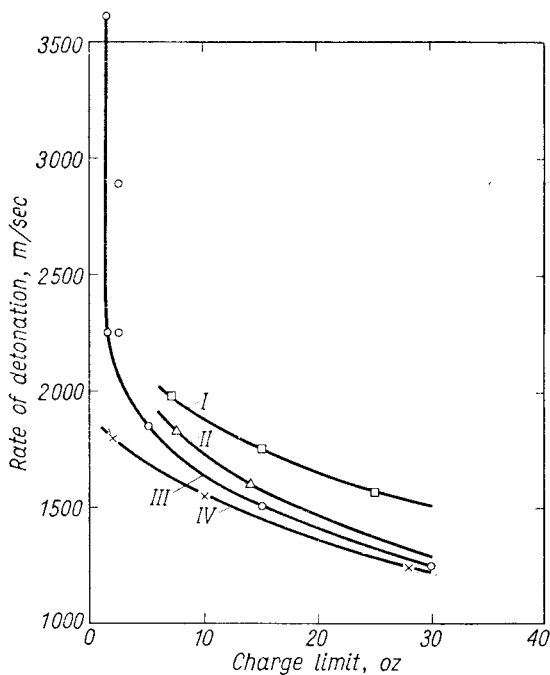

FIG. 134. Relationship between charge limit and rate of detonation of explosives suspended in methane-air mixture, according to J. Taylor [41]; I—explosive containing no cooling salt; II—explosive containing 10% sodium chloride; III—explosive containing 50% sodium chloride; IV—explosive based on sodium nitrate.

gallery at two different rates of detonation: 2400 m/sec by initiation with an ordinary detonator and 4800 m/sec by priming with a tetryl pellet. Initiation was from the bottom of the bore. The charge limits were respectively 14–16 oz and 10–12 oz, a difference which is almost negligible. Finely ground TNT, with a rate of detonation of 4100 m/sec, and coarse grained TNT, with a rate of detonation of 1680 m/sec behave similarly: their charge limit is the same: 2–4 oz.

However, J. Taylor found that the converse may also hold good: on the detonation of an explosive freely suspended in a chamber filled with a mixture of 9% methane in air (i.e. not fired in a mortar), the relationship between the charge limit and the rate of detonation (Fig. 134) is clearly marked in explosives of similar composition. Murata [42] came to the same conclusion. Likewise, if detonation is initia-

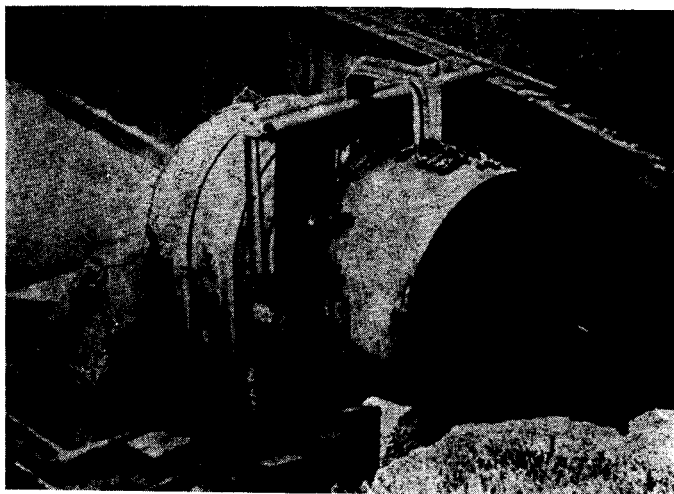

FIG. 135. Free suspension test gallery, according to J. Taylor and Gay [4].

ted near the mouth of the test mortar, i.e. conditions similar to those of firing an explosive suspended in a methane–air mixture, the rate of detonation has a pronounced effect on the charge limit, i.e. the higher the rate, the smaller the charge.

The procedure for testing with the explosive charges suspended in the methane–air mixture, as carried out at Ardeer, Great Britain, and described by J. Taylor and Gay [4] is shown in the photograph (Fig. 135). The diagram (Fig. 136) shows the test lay-out.

This kind of situation usually does not occur in coal mining practice, but in fact there have been instances when an explosive charge has been fired across gaps filled with methane inside the shothole. The conditions characteristic of the firing of explosive charges suspended in a methane–air mixture are then very similar to those met in practice.

Experiments have shown that the ejection of detonation products perpendicular to the axis of the charge (angle detonation) is more dangerous than ejection from an ordinary mortar, i.e., in the direction of the mortar's axis (Payman and

Wheeler [43]; J. Taylor and Hancock [44]). A special mortar, the "angleshot mortar" is used for determining the effect of this phenomenon. It is shown diagrammatically in Fig. 137. This is a diagram of equipment used at the German testing station at Dortmund-Derne (J. Taylor and Gay [4]). A steel ricochet plate from which the detonation products are reflected is situated alongside the mortar. The angle of reflection of these products depends on the angle of the mortar with respect to the ricochet plate.

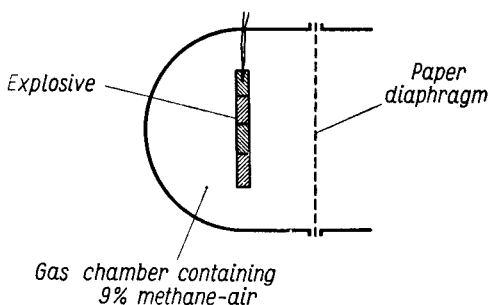

FIG. 136. Diagram of free suspension test gallery, according to J. Taylor and Gay [4].

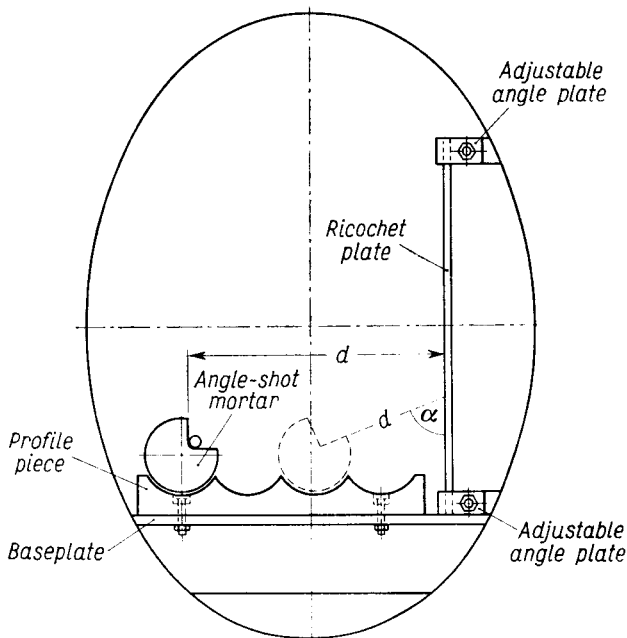

FIG. 137. Diagram of angle-shot mortar test at Dortmund-Derne, according to J. Taylor and Gay [4].

The latter may be 90° or less, as is shown in Fig. 137. The reflection of the detonation products from a barrier such as the ricochet plate involves a violent rise in temperature at this spot, due to the adiabatic compression of gases. A general view of angle shot mortar at Derne is given on Fig. 138.

In Poland another system is also known that works on the same principle as the angle-shot mortar. This is a mortar with a horizontal slit. Figure 139 shows diagrammatically the arrangement in a rectangular section gallery at Mikołów.

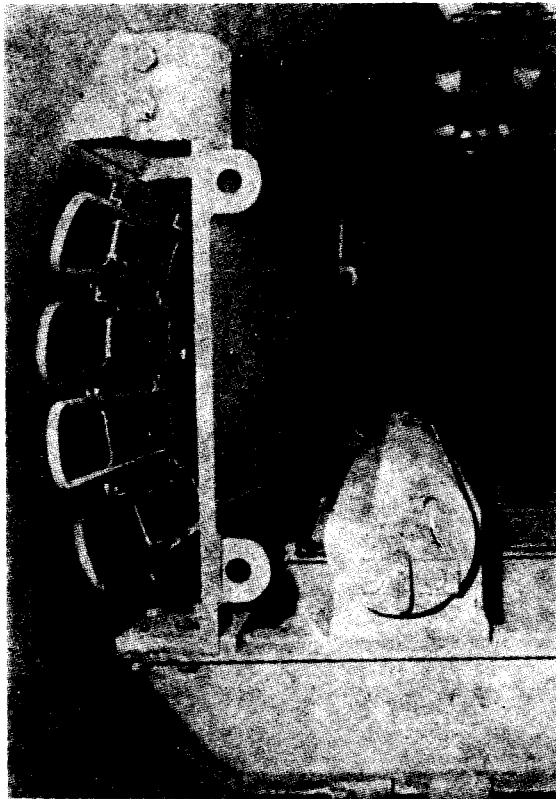

FIG. 138. General view of angle-shot mortar at Dortmund-Derne [45].

According to Cybulski's studies [46, 47] the severity of this test is increased by the prolonged effect of high temperature on the cloud of coal-dust: in the first stage volatile matter is released from the coal-dust, and only afterwards does the ignition of the explosive system occur. Ignition of coal-dust may be achieved more easily by the simultaneous detonation of several shots. Firing in the angle-shot mortar gives results which approach the natural condition of working in coal mines to a much greater degree than firing in the classical mortar. According to Cybulski [39] the classical test gives less reliable results than the angle-shot method.

Deflagration of mining explosives. Long experience in the use of explosives in mining shows that some high explosives undergo deflagration instead of detonation in a shothole. Delayed shots then occur, commonly called "blown-out shots" (gekochte Schüsse).

Such shots are characterized by the fact that immediately after firing the detonator there is no report which is the normal acoustic effect. Instead, after a certain

delay, the gas pressure in the shothole increases due to combustion of the explosive, and the stemming is ejected with a report similar to that of a normal shot. The course of deflagration may differ with the conditions. Deflagration, however, always creates a great danger of ignition of methane since the deflagrating explosive gives a flame of long duration and of very large dimensions. Moreover, the explosive does not carry out the normal work of blasting, but only achieves the insignificant result of ejecting the stemming. Since, therefore, the heat of the explosive decomposition is not converted into work, the temperature of the deflagration flame is very high and hence more dangerous.

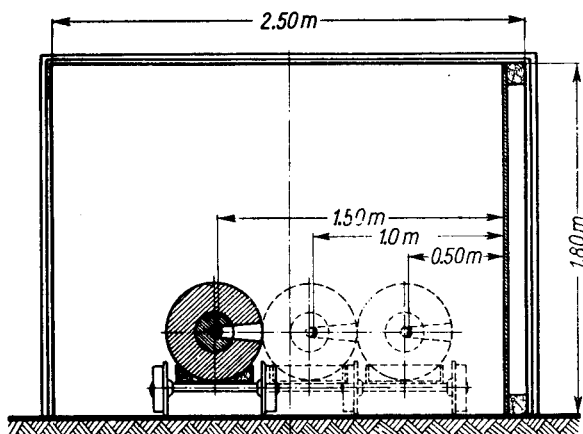

FIG. 139. Diagram of a mortar with slit in a gallery at Mikołów (Poland).

It has long been known that inflammable explosives, such as dynamites, and especially chlorate and perchlorate explosives are particularly prone to deflagration. This is one of the reasons why chlorate and perchlorate explosives have either been withdrawn from use in mines in a majority of countries or restricted to use in rock, where there are no inflammable gases.

The ammonium nitrate explosives are much harder to deflagrate and are therefore generally recognized as the safest, although they may deflagrate under certain conditions.

The first systematic studies which elucidated the conditions under which explosives and especially ammonium nitrate ones undergo deflagration, were carried out by Cybulski [48]. This work indicated that deflagration of explosives, including ammonium nitrate ones, may occur in mining practice, if they happen to be mixed with coal-dust in the vicinity of the detonator. The sensitiveness of an explosive to detonation is then reduced, but its ignitability is increased, hence the explosive takes fire instead of being detonated. Ammonium nitrate explosives are readily detonated, but are ignited with difficulty. Clearly, this is their great advantage, but nevertheless, under the conditions described above (admixture with coal-dust) they may be sub-

ject to deflagration. Mixing with coal-dust may result from incorrect loading of the shothole and from negligence over freeing the shothole from coal-dust. Careful loading of the shothole and the use of ammonium nitrate explosives is a sufficient guarantee for the prevention of delayed shots.

Cybulski established that penetration of coal-dust into the explosive near the detonator is most dangerous, creating conditions particularly favourable to deflagration.

Explosives containing nitroglycerine and also chlorate explosives are more liable to deflagration than those containing ammonium nitrate without nitroglycerine.

When a partial misfire occurs in the shothole, there is great danger that the charge will deflagrate. The hot detonation products act on the undetonated remnant of the

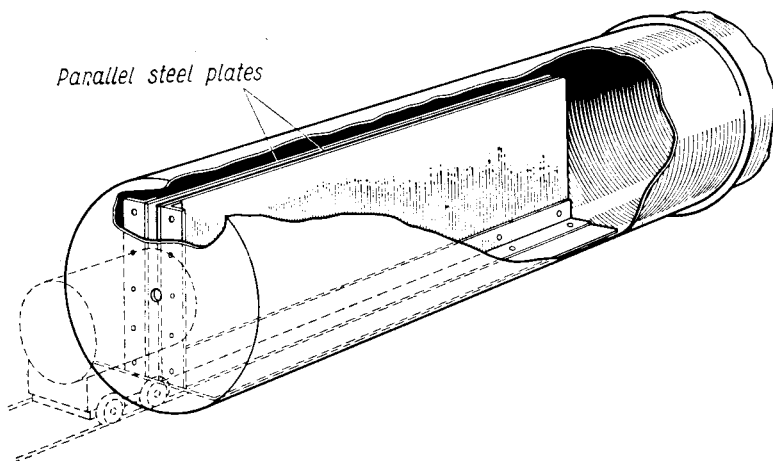

FIG. 140. Diagram of break gallery, according to J. Taylor and Gay [4].
(By permission of Controller H.M. Stationery Office.)

charge and may initiate it. It may happen that detonation of a part of the charge opens the shothole by ejecting the stemming or by shattering some coal. The deflagration of the remaining part of the charge may then be prevented.

A partial misfire may have various causes. For instance, the charge may be contaminated by coal-dust, as described above. The incomplete detonation of hardened cartridges of ammonium nitrate explosive occurs widely. It is obvious that the incomplete detonation of damp explosives is also possible.

Cybulski's [48] extensive investigations in coal and rock have also solved the problem of the double detonation. It is now known that the deflagration of an explosive in the shothole may pass into detonation after a certain time. This occurs with particular ease in nitroglycerine explosives. The results of Cybulski's studies [48] are now taken into consideration in Poland in defining which explosives may be used in mining.

In Great Britain a test was devised for simulating the effect of blown-out shots in a shothole. Small charges of explosive were fired, from a suspended position or from a gun, in a methane-air mixture between two steel plates 2-4 in. apart in a "break gallery" (Fig. 140) developed by Shepherd and Grimshaw [49].

Explosibility of coal-dust. It is of great importance to know the conditions governing the explosion of coal-dust in order to develop methods of preventing it. Extensive, fundamental studies have been carried out in leading coal producing countries [50]. In Poland they have been carried out by Cybulski since 1925, mainly on a great scale in an underground testing gallery 200 m long and also in smaller galleries 44 and 100 m long.

Cybulski [51] found that there is a straight line relationship between the explosibility of coal-dust and the specific surface area of the dust. This may be expressed by the formula:

$$Z = 0.0010119 F + 0.7836578, \text{ where}$$

Z —degree of explosibility of the dust,
 F —the specific surface area of dust.

Cybulski has shown that very fine coal-dust contains a higher proportion of volatile matter than the average sample. This increases the danger created by fine coal-dust.

Cybulski [52] has also shown that very fine coal-dust may explode even when it contains less than 12% combustible volatile matter. The presence of a significant amount of water in coal-dust may lead to its explosion even if free from volatile matter. This indicates the particularly hazardous nature of fine coal-dust. Cybulski has also shown that under particularly unfavourable conditions the coal-dust must contain as much as 95% incombustible matter (e.g. by admixture with non-inflammable stone dust) if explosion is to be avoided.

More recently attention has been paid to the problem of the explosive properties of sulphur dust suspended in air. This is of great importance to work with explosives in sulphur mines.

Sulphur dust is more dangerous than coal-dust, because of the low ignition temperature of sulphur suspensions in air. According to Dubnov [53] 100 g charges of the U.S.S.R. explosives Ammonit No. 1 and 8 ignited sulphur dust. The same explosives did not ignite a methane-air mixture when the quantities were 400 and 500-650 g respectively. In sulphur mines explosives of very low detonation temperature should be used.

FUNDAMENTAL COMPONENTS OF MINING EXPLOSIVES

The ample theoretical and practical material derived from investigations of mining explosives in testing stations and from mining practice led to the conclusion that the composition of mining explosives should be subject to certain rules aimed at the highest possible safety in the use of the explosives together with the conservation of maximum working efficiency. These rules are stated below.

OXYGEN CARRIERS

Nitrates. The chief oxygen carrier, employed in all modern explosives, is ammonium nitrate (it is discussed more fully in Vol. II, p. 450).

In some countries (Great Britain) ammonium nitrate is used with an admixture of triphenylmethane dye, Acid Magenta which inhibits the transformation of one crystalline form into the other at 32°C (Vol. II, p. 454).

Substances that reduce hygroscopicity are also frequently added. This is discussed more fully in Vol. II (p. 453). The substances used are: carboxymethylcellulose and calcium stearate (J. Taylor and Sillitto [54]). Silicone resins are used in France.

In mixtures in which sodium chloride occurs together with ammonium nitrate, there is a possibility of molecular exchange and of the formation of the more stable system: sodium nitrate-ammonium chloride:

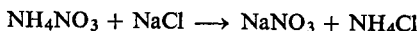

Kreyenbuhl and Sartorius [55] found that this exchange proceeds slowly if the moisture content is less than 1%. If it is 1% or more so, the exchange is complete after 3-6 months and is accompanied by decreased explosive power. The addition of a moisture absorbent (e.g. urea resin foam) inhibits this exchange (French explosive Noburex, p. 552).

Alternatively, the use of mixtures with sodium nitrate and ammonium chloride have been proposed in place of those containing ammonium nitrate and sodium chloride (see below). Other nitrates—sodium, potassium, barium—are of minor importance. They are generally used in insignificant amounts in admixture with ammonium nitrate. The use of potassium nitrate has been prohibited in Germany since 1925, when it was thought that the presence of potassium nitrate in some ammonium nitrate explosives may cause the ignition of methane-air mixtures. It was believed that the decomposition of potassium nitrate during detonation proceeds too slowly and may cause a long duration of flame. Although this was not proved experimentally, the prohibition has remained in force and potassium nitrate has been replaced by barium nitrate.

Sodium nitrate is often employed as an oxygen carrier in dynamites.

For some time mixtures of safety explosives containing sodium nitrate with ammonium chloride were recommended instead of ammonium nitrate with sodium chloride since the system $\text{NaNO}_3 + \text{NH}_4\text{Cl}$ is more stable than $\text{NH}_4\text{NO}_3 + \text{NaCl}$ (see above). According to the investigations of Hackspill, Rollet and Lauffenburgier [56] the system sodium nitrate-ammonium chloride is stable at room temperature. These observations led to studies of explosive mixtures with sodium nitrate and ammonium chloride. At first, the results were encouraging. Thus Ahrens [57] established that the safety of these explosives seems to be greater than that of explosives with ammonium nitrate and sodium chloride. It was believed that this is due to formation of free sodium ions at high temperature. This can be represented

diagrammatically:

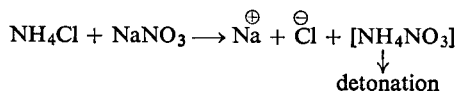

The power of explosives containing sodium nitrate and ammonium chloride was found to be the same as that for equivalent compositions containing ammonium nitrate and sodium chloride [58]. The compositions with ammonium chloride-sodium nitrate are now very popular in France, Germany, Belgium and Great Britain.

However with poor ventilation they seem to give more persistent smoke than compositions based on ammonium nitrate and sodium chloride. Analysis of the smoke showed it to be due to finely divided ammonium chloride suspended in moist air, and although not harmful it may be objectionable to the miners. In addition, calcium sulphate was included to suppress the smoke (J. Taylor and Gay [4]). Calcium nitrate found only a limited use as a substance for lowering the temperature of detonation flame.

Murata [42] showed that the addition of a few per cent of potassium and sodium nitrates somewhat increases the safety of an explosive with respect to methane but in larger quantities their effect is almost negligible.

Perchlorates

Perchlorates are not used now as oxygen carriers in safety explosives. Perchlorate explosives were used temporarily during World War I, and later a small admixture of potassium perchlorate was introduced into ammonium nitrate safety explosives such as Bradyt F (p. 475), used for a certain time in Poland. Potassium perchlorate was added on the assumption that during explosive decomposition it may promote the formation of an additional amount of potassium chloride, a substance inhibiting the explosion of methane-air mixtures. Bradyt F did in fact prove to be highly safe on examination in a testing gallery. Moreover, an admixture of perchlorates increases the sensitiveness to detonation in ammonium nitrate explosives. At present, perchlorates are used as ingredients of ammonium nitrate explosives only in Belgium, France and Japan.

Chlorates

Chlorates have been little used. Only potassium chlorate has been employed as a non-hygroscopic ingredient in the simplest rock explosives, including Miedziankit (p. 278). Experience of many years proves that such explosives often burn out in the shothole, creating a great risk of fire. As was pointed out earlier (Vol. II) chlorates should never be mixed with ammonium salts (such as ammonium nitrate), because of the formation of highly unstable ammonium chlorate. At present, chlorate explosives are banned in underground mines in the majority of countries and their use in coal mines is prohibited everywhere.

ACTIVE INGREDIENTS AND COMBUSTIBLES

All ammonium nitrate explosives containing non-explosive salts (e.g. sodium or potassium chloride) should include at least 4% nitroglycerine to increase their sensitiveness to detonation. Small amounts of nitroglycerine (up to 6–8%) do not require gelatinization with nitrocellulose; it is enough to introduce a certain quantity (up to 2%) of woodmeal into the mixture to absorb nitroglycerine and to prevent its exudation. In addition, the woodmeal stabilizes nitroglycerine explosives by absorbing impurities and the product of decomposition of the ingredients. Explosives containing woodmeal therefore possess enhanced chemical stability.

If the content of nitroglycerine exceeds 10%, the explosives are called dynamites. It is then necessary to bind the nitroglycerine with highly viscous "dynamite collodion cotton" (Vol. II). Dynamites thus acquire a plastic consistency which is a very convenient form of mining explosive, facilitating the introduction of a detonator with a fuse. In countries where the explosive may be exposed to frost, a mixture of nitroglycerine with nitroglycol or nitrodiglycol should be used, since the explosive then retains its plasticity even at low temperatures. In the U.S.S.R. another type of plastic explosive with nitroglycerine was recently introduced containing a 3–5% solution of methyl polymethacrylate in nitroglycerine.

Woodmeal is of particular importance among combustible ingredients since apart from its stabilizing effect, discussed above, it enables the mixture to be retained in a loose state with a low density. Charcoal is another ingredient sometimes added.

The addition of aluminium to increase the heat of the explosion and, in consequence, the power of the explosive, as practised for some time, is now believed to be too dangerous. Ammonium nitrate explosives with aluminium are permitted only for rock work in opencast mining (e.g. quarries) or underground, where there is no methane.

Ammonium nitrate explosives usually contain a certain amount of nitro compounds from mononitro (e.g. nitronaphthalene) to trinitro compounds (e.g. trinitrotoluene).

Some ammonium nitrate explosives used in the U.S.S.R. contain a small amount of paraffin (0.5–1%) to reduce the hygroscopicity of the ammonium nitrate.

Recently Hino and Yokogawa [59] found that by adding less than 1% surface active agents, an improvement of transmission of detonation of ammonium nitrate explosives can be achieved.

OXYGEN BALANCE

The maintenance of an adequate oxygen balance in a mixture is a problem of high importance. Former German explosives of the Carbonit type*, with incomplete combustion, have been banned. Modern mining explosives are required to have an oxygen balance equal to or higher than zero. Investigations in the U.S.S.R. have

* Carbonits had a negative oxygen balance on the wrong assumption that incomplete combustion gives greater safety for use in mines, by lowering the heat and temperature of explosion.

shown that a highly positive balance is disadvantageous since it favours the formation of nitric oxides in the products of an explosion. For earth moving, farming, and opencast mining the use of explosives with a negative oxygen balance (e.g. picric acid, TNT etc.) is permitted.

According to Soviet findings a concentration of carbon monoxide of less than 0.00025% is admissible in the atmosphere of a coal mine, after ventilation of the shotfiring position. Before ventilation, immediately after shotfiring, the content of CO should not exceed 0.02%.

A positive oxygen balance markedly reduces the quantity of carbon monoxide formed. Assonov and Rossi [60] report the following results of experiments on the effect of the oxygen balance of explosives on the composition of the gaseous products of explosion (Table 99).

Other agents also examined in the U.S.S.R. exert an influence on the combustion of the products of an explosion. According to Assonov and Rossi [60] increase in the moisture content of an explosive involves the increase in the content of gaseous products.

TABLE 99
COMPOSITION OF GASEOUS PRODUCTS OF EXPLOSION IN EXPLOSIVES WITH
A DIFFERENT OXYGEN BALANCE

Explosive	Oxygen balance %	Content of toxic gaseous products (1. per kg of explosive)	
		carbon monoxide	nitric oxides
2 T Ammonit	+9.0	15.0	25.1
No. 1 Dinaftalit	+0.6	7.0	7.3
T Ammonit	-1.0	7.5	6.2
Dynamon	-9.8	95.6	6.5

Other factors include the density of loading (with a larger density a smaller quantity of nitric oxides is obtained), the diameter of the cartridge (a larger diameter favours the reduction of the amounts of carbon monoxide and nitric oxides); e.g. after the explosion of 62% dynamite* 8.5 l./kg of carbon monoxide and 4.2 l./kg of nitric oxides were found in the gaseous products, with cartridges 30 mm dia. With cartridges 20 mm dia. the figures were 9.0 l./kg and 12.5 l./kg respectively.

Cybulski [61] and Assonov and Rossi also found that if made of paper saturated with paraffin, the cartridge case affects the composition of the gaseous products, considerably increasing the quantity of carbon monoxide.

Assonov and Rossi report that with a proportion of 2 g of paper per 100 g of explosive, the content of paraffin should be less than 2.5 g. With this paraffin content the amount of toxic gases formed is 26.4 l./kg of carbon monoxide and 37.7 l./kg of nitric oxides.

* 62% dynamite means a "straight" dynamite containing 62% nitroglycerine or a dynamite of the same power as one with 62% nitroglycerine, according to U.S.A. nomenclature.

If the content of paraffin is 4.0 g, 29.5 l./kg of carbon monoxide and 59.7 l./kg of nitric oxides are formed.

According to Taffanel [62] paraffin paper also reduces the safety of an explosive towards methane. He established this for explosives with a high oxygen balance (Grisounaphthalite and Grisoudynamite, with oxygen balance +13 and +18% respectively). As shown by Murata [42] this phenomenon occurs only in explosives with a highly positive oxygen balance. If an explosive has only a slightly positive oxygen balance, the presence of paraffin paper tends to enhance its safety (Fig. 141).

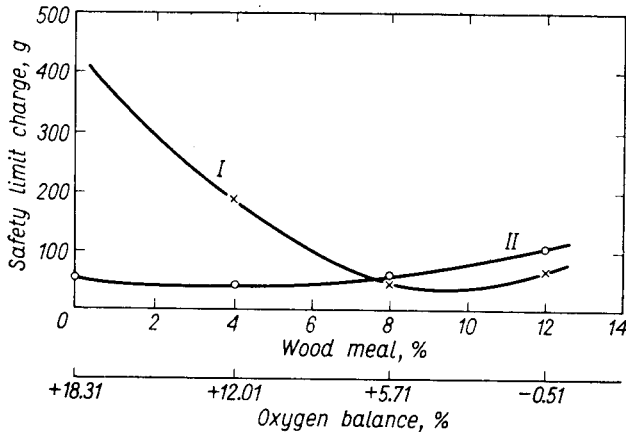

FIG. 141. Effects of paraffined paper cartridges upon the safety of explosives of various oxygen balances: I—cartridge of paper only; II—paraffined paper cartridge (according to Murata [42]).

Good stemming, occupying at least $\frac{1}{3}$ of the shothole, prevents the formation of large amounts of toxic gases.

Experiments carried out in the U.S.S.R. have shown that the content of carbon monoxide and nitric oxides in the products of an explosion is influenced by the medium in which the explosion takes place. The quantity of carbon monoxide and nitric oxides is higher with shotfiring in coal and lower in copper and iron ore seams. The figures given by Assonov and Rossi are summarized in Table 100.

TABLE 100

QUANTITY OF TOXIC OXIDES FORMING IN THE PRODUCTS OF EXPLOSIONS OCCURRING IN VARIOUS SEAMS

Explosive	Shotfiring			
	in coal		in iron ore	
	carbon monoxide l./kg	nitric oxides l./kg	carbon monoxide l./kg	nitric oxides l./kg
2 Ammonit	40.7	29.8	4.7	7.9
62% Dynamit	54.3	4.8	3.3	8.0

Calculation of the oxygen balance is carried out by taking into consideration the quantity of oxygen supplied by the oxygen carrier and that required by the combustible ingredients of the explosive mixture. The figures for the most frequently used ingredients are tabulated below.

TABLE 101

QUANTITY OF OXYGEN GIVEN OR REQUIRED BY INGREDIENTS OF
MINING EXPLOSIVES

Oxygen carrier	Quantity of oxygen (kg) given by 1 kg of the substance
<i>Inorganic salts</i>	
Ammonium nitrate	+0.200
Ammonium perchlorate	0.340
Barium chlorate [Ba(ClO ₃) ₂ ·H ₂ O]	0.298
Barium nitrate	0.306
Calcium nitrate [Ca(NO ₃) ₂ ·4H ₂ O]	0.339
Potassium chlorate	0.396
Potassium nitrate	0.396
Potassium perchlorate	0.462
Sodium chlorate	0.450
Sodium nitrate	0.470
<i>Organic substances</i>	
Nitroglycerine	0.035
Tetranitromethane	0.490
Substances requiring oxygen	Quantity of oxygen (kg) required for total combustion of 1 kg of the substance
Aluminium	-0.890
Cellulose (C ₆ H ₁₀ O ₅)	1.185
Charcoal	2.667
Cyclonite (RDX)	0.216
Diglycoldinitrate (DGDN)	0.408
Dinitronaphthalene	1.394
Dinitrotoluene (DNT)	1.144
Nitrocellulose (11.95% N)	0.387
Nitroglycol	0.000
Nitroguanidine	0.308
Nitronaphthalene	1.988
Penthrite	0.100
Sulphur	1.000
Trinitrotoluene (TNT)	0.740
Trinitroxylene	0.896
Woodmeal (C ₆ H ₁₀ O ₅)	1.185

INERT INGREDIENTS INCREASING SAFETY

Long experience has shown that the most efficient non-explosive ingredients for increasing the safety of explosives towards methane and coal-dust are sodium and potassium chlorides. The latter is more efficient due, no doubt, to the action of the potassium ion which inhibits explosive reactions in the gaseous phase. This will be considered further when discussing the problem of securing flashless discharge from guns (p. 544). An explosion of a methane-air mixture is a phenomenon of the same type as the explosion of a mixture of muzzle gases with air. It is also beyond question that as in the latter case, the inhibition of an explosion of a methane-air mixture is to a less degree a thermal phenomenon which results from the temperature fall of the igniting flame. To a much higher degree it is based on the spraying in gas of a substance containing potassium ions. A number of authors have shown that this is not only a thermal phenomenon. For instance Dubnov [38] proved this by experiments in which he added sand instead of sodium chloride to the explosives. He matched the quantity of sand so that the heat capacity was the same, and found that the presence of sand cannot prevent explosion of a methane-air mixture.

Dubnov [53] also reports the results of experiments in a testing gallery. The charge consisted of 90% of 80/20 ammonit (80% ammonium nitrate and 20% TNT) and 10% of various salts. A steel mortar was loaded with a 200 g charge, without stemming, and fired in an atmosphere containing 8-10% methane. The percentage number of ignitions of methane was then determined (Table 102).

TABLE 102

Salt	Specific heat	Percentage ignition of methane
KF	0.200	0
KH ₂ PO ₄	0.208	20
KCl	0.162	40
K ₂ SO ₄	0.178	40
KNO ₃	0.221	60
NaCl	0.206	60
Na ₂ CO ₃	0.273	70
CaF ₂	0.215	80
CaCO ₃	0.189	100
NH ₄ Cl	0.363	100
Pb(OOCCH ₃) ₂	0.134	100

These figures show that a high specific heat is not correlated with inhibition of explosion of methane. E.g. the high specific heat of ammonium chloride does not help this salt to inhibit methane explosions.

As mentioned previously (p. 421) ammonium chloride and sodium nitrate in stoichiometric proportion has also been suggested, as an effective source of sodium ions which possess marked ability to inhibit methane explosions.

Dubnov examined the effect of various salts on the ignition temperature and on the explosion lag of methane-air mixtures (Table 103).

TABLE 103
EFFECT OF THE ADDITION OF VARIOUS SALTS ON EXPLOSIVE PROPERTIES

Salt	Minimum ignition temperature °C	Explosion lag (sec) at different temperatures							
		750°C	760°C	770°C	780°C	790°C	800°C	810°C	820°C
No salt added	710	1.8	1.0	1.0	0.8	—	—	—	—
CaCO ₃	710	1.4	1.1	0.9	0.7	—	—	—	—
NaCl	730	3.2	1.9	1.4	1.0	0.8	0.6	—	—
LiCl	790	—	—	—	—	—	4.2	2.2	1.95
KCl	800	—	—	—	—	—	5.6	3.9	1.85
CaCl ₂	810	—	—	—	—	—	—	4.0	3.0

These experiments confirm that the efficiency of potassium chloride is higher than that of sodium chloride in inhibiting explosion. (On inhibition of other gaseous explosive mixtures by potassium chloride see papers by Prettre [63]).

Highly interesting results were obtained by Murata [42], showing very high efficiency of potassium chloride and somewhat lower efficiency of sodium chloride. Investigations on the effect of potassium and sodium nitrate are also noteworthy. They were found to have a beneficial influence only when a few per cent were used; in greater quantity they have practically no effect.

According to Dubnov [53] ammonium chloride seems to be particularly suitable as a cooling agent in explosives for sulphur mines.

Dubnov [53] also describes experiments which prove that the activity of an inert salt increases with its fineness (Table 104). The figures in the Table refer to sodium chloride. An explosive charge containing 35 or 40% sodium chloride was detonated in a methane-air mixture.

TABLE 104
ACTIVITY OF INERT SALT AS A FUNCTION OF ITS FINENESS

Average size of the particles of sodium chloride mm	Content of sodium chloride %	Percentage ignitions	Power of explosive according to lead block test
1.38	35	100	221
1.16	35	100	219
0.70	35	70	210
0.38	35	85	216
below 0.14	35	10	192
1.38	40	100	197
0.70	40	45	187
0.38	40	5	181

Recently "ultra-safe" explosives were introduced in Great Britain. They contain cooling salts ground to a finer size than it is customary (p. 467).

Dubnov [53] reports figures depicting the relationship of charge limit, power, heat of detonation and temperature and sodium or potassium chloride content for an explosive containing ammonium nitrate and TNT in the proportion 80 : 20 (Table 105).

TABLE 105

CHARGE LIMIT AND POWER OF EXPLOSIVES AS A FUNCTION OF SODIUM OR POTASSIUM CHLORIDE CONTENT

Content of inert salt %	Charge limit g		Lead block expansion cm ³		Heat of detonation kcal/kg		Calculated temperature °C	
	NaCl	KCl	NaCl	KCl	NaCl	KCl	NaCl	KCl
	10	100	150	340	342	817	845	2100
15	200	250	296	298	745	774	2040	2070
20	350	450	272	279	673	703	1980	2023
25	450	550	245	254	600	632	1920	1975
30	550	650	214	226	525	560	1860	1926

It is interesting to note that the compositions containing potassium chloride gave higher calculated values of the heat and temperature of explosion. In spite of this, the efficiency of potassium chloride as an agent increasing the safety of the use of the explosive in presence of fire-damp is higher. It confirms the former observation that potassium ions are efficient inhibitors of gas explosions.

Murata [42] reported similar results for explosives containing ammonium nitrate, 8% of nitroglycerine, 0.3% of nitrocellulose and 8% of woodmeal. Sodium or potassium chloride in proportion 1-15% and 1-10% respectively replaced the corresponding part of ammonium nitrate.

In 1914 Lemaire [64] proposed the use of a sheath made of incombustible and inexplusive substances in explosive charges. As an inert material he recommended: milled sand, salts containing water of crystallization (e.g. sodium sulphate), salts volatilizing at high temperatures (e.g. sodium chloride, sodium fluoride, cryolite), salts decomposing at high temperatures (e.g. ammonium chloride). Sheaths were made by placing the substance between the dual walls of a paper tube.

The preliminary experiments indicated the importance of this discovery. It was found, for instance, that even 800 g of blasting gelatine fitted with a sheath of sodium chloride or sodium fluoride weighing as much as the explosive itself failed to ignite methane or coal-dust. On the other hand 100 g of blasting gelatine, without an inert sheath, was enough to cause explosion of methane or coal-dust.

After investigations carried out in Belgium at the Institut National des Mines de Pâturages in 1930, an inert sheath with the following specification was introduced:

thickness of mantle: 3 mm

composition: 25% of binder (usually calcium sulphate or clay)

75% of salts: sodium or calcium fluoride or sodium chloride with an admixture of at least 35% of sodium fluoride.

The total weight of material forming the sheath was 65 g per 100 g of explosive. Later, the thickness of the mantle was increased to 5 mm in safety explosives (S.G.P.—p. 447) and to 6.5 mm in rock explosives.

In 1947, sodium hydrogen carbonate was introduced as the most efficient salt.

About 1933 work on the use of sheaths of this kind was also started in other countries. In the U.S.S.R. sheaths of 9 mm thickness composed of powdered salts in paper tubes were adopted.

In the Home Office Gallery at Buxton (Great Britain) the effect of the following groups of substances used for filling the sheaths was tested:

- (1) Substances preventing explosion of methane-air mixture, e.g. potassium chloride;
- (2) Cooling substances with high thermal conductivity, e.g. iron chips;
- (3) Substances evolving incombustible gases, assumed to form a gaseous sheath around the explosion, e.g. sodium hydrogen carbonate;
- (4) Reducing substances which may combine with atmospheric oxygen, thus removing the ingredient necessary for the explosion of methane, e.g. sodium hydro-sulphite.

Experiments in a testing gallery showed that addition of the majority of these substances increases the charge limit to such an extent that it cannot fit into the mortar. For this reason, a very strict test was carried out on the basis of the detonation of an explosive directly suspended in a methane-air mixture. Under such conditions the charge limit was diminished nearly four times as compared with that determined for a mortar.

TABLE 106

Substance in a sheath	Charge limit g
No sheath	56
Kieselguhr	113
Lead sulphate	170
Sodium thiosulphate	170
Sodium hydrogen sulphite	170
Sodium formate	226
Manganese dioxide	226
Ferrous oxalate	226
Hydrated sodium carbonate	226
Sodium hydrosulphite	283
Sodium hydrogen carbonate	283
Iron chips	340
<i>a</i> and <i>b</i> Belgian mixtures	170
<i>c</i> Belgian mixture	226

Table 106 presents the results of some experiments on the Tees Powder explosive (p. 405) provided with a sheath 4 mm thick.

On the basis of these experiments a sheath was introduced in England filled with sodium hydrogen sulphite, a cheap substance and fairly efficient when in the form of a mantle about 2.5 mm thick, protected from the outside by non-impregnated watertight paper. The explosives which may be used with a sheath of this kind are designated by the symbol "S" (sheathed).

The use of sheaths very slightly weakens the strength of an explosive but does not reduce its sensitiveness to detonation. On the other hand it considerably increases its safety for use in mines with methane and sensitive coal-dust.

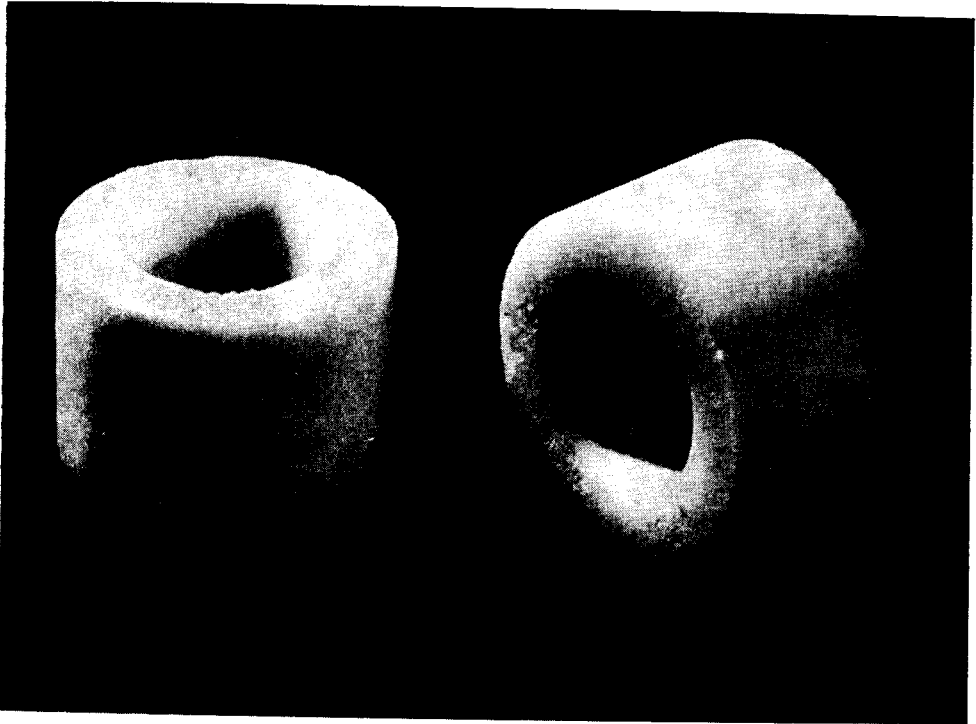

FIG. 142. Rings of sodium chloride or sodium hydrogen carbonate for making rigid sheaths (Courtesy Dr. L. Deffet, Sterrebeck, Belgium).

The production of sheaths has led, however, to some new and unexpected difficulties. Thus, the explosive core was sometimes not sufficiently well centered, or the substance filling the sheath moved to one end and formed a barrier to the transmission of detonation from one cartridge to another.

It is also evident that the increased safety produced by using sheathed explosives is lost if the sheath is removed deliberately. The latter may happen, for instance, if the hole into which the charge is being loaded is too narrow.

To avoid this danger various solutions were suggested and introduced, for instance, the use of rigid sheaths. In Belgium these were made by the compression

of rings of sodium chloride or sodium hydrogen carbonate (Fig. 142) or by the extrusion of mixtures of sodium chloride with wet clay which was then dried.

This arrangement has the additional advantage that it facilitates detonation. In the U.S.S.R. Seleznev suggested [60] a rigid sheath composed of china clay, sodium chloride and calcium sulphate.

Another method of increasing the mechanical strengths of sheaths was suggested by Fleming [65]: it consisted of making them from "bicarbonate felt"—90% sodium hydrogen carbonate and 10% paper pulp.

In Great Britain an alternative solution was found. The inert material was directly and uniformly incorporated into the explosive itself, instead of forming a separate sheath (J. Taylor [66]). These explosives were marked "Eq. S.", i.e. equivalent in safety to sheathed explosives of the same class.

In addition to the ordinary inert sheath, an active sheath in Germany and the U.S.S.R. consisting of "cooling" salts admixed with nitroglycerine has been developed, for the following reasons:

(1) The substance of a sheath is better sprayed after the detonation owing to the presence of nitroglycerine taking part in the detonation and since it is then better mixed with the detonation products of the explosive;

(2) Being an explosive, the sheath does not weaken the charge and does not inhibit the transmission of detonation from one cartridge to another.

In Germany sheaths consisting of 12 or 15% nitroglycerine, 33 or 35% sodium chloride and 50 or 55% sodium hydrogen carbonate are used. Each cartridge comprises 70 g of explosive and 50 g of sheath.

In the U.S.S.R. a sheath composed of nitroglycerine, sodium chloride, potassium chloride, sodium nitrate and woodmeal is employed.

In Belgium "Bicarbite" special charges have been introduced, consisting of 85% sodium hydrogen carbonate and 15% gelatinized nitrocellulose. Cartridges of this composition are placed in the shothole alternately with explosive cartridges. By altering the proportion of explosive cartridges to Bicarbite ones the degree of safety towards methane and coal-dust can be modified.

Recently Boucard and Deffet [67] examined the action of organic compounds containing halogens, such as: carbon tetrachloride, hexachloroethane, γ -hexachlorocyclohexane, chlordane ($C_{10}H_6Cl_8$), iodoform and also iodine.

It was found that the organic compounds in question could inhibit the explosion of methane-air mixture particularly if they were first subjected to a thermal decomposition. It seems advisable to add these compounds to explosives so that they undergo some decomposition in the course of the detonation. They do not seem to form substances increasing the safety by themselves.

INERT NEUTRALIZING AGENTS

Since ammonium nitrate always contains a small amount of free nitric acid a certain amount of substances to neutralize the acid should also be added to ammon-

ium nitrate explosives containing nitroglycerine. Since soluble bases (e.g. sodium hydrogen carbonate) exert a negative influence on ammonium nitrate and other ingredients of explosive mixtures such as TNT, insoluble bases, e.g. calcium or magnesium carbonates, should be employed. Ferric oxide may also be used, e.g. in the form of pyrites ash.

In explosives which contain a small amount of nitroglycerine (4–8%) the addition of woodmeal (p. 423) provides adequate stability.

To reduce the density, a larger amount (6–12%) of light woodmeal, peat meal or vegetable fibre (e.g. cellulose) is sometimes added. This brings about a considerable reduction in density (to 0.70) and increases the sensitiveness of the explosive to detonation.

Powdered plastic foam may also be used for this purpose.

In the U.S.S.R. a cartridge of a basic substance was added to charges of explosives to neutralize the acid and harmful products which might result from incomplete detonation (e.g. nitrogen dioxide). This was a cartridge comprising calcium hydroxide in an amount equal to 25% weight of the whole stemming. This reduced the quantity of acid gaseous products (CO_2 and NO_2) by 10–20%.

The addition of water to the stemming has a similar effect.

An important ingredient for improving the composition of the products of explosion used in Great Britain is calcium sulphate.

The effect of the addition of barium sulphate has also been tested in Great Britain. This substance has the exceptional property of sensitizing a nitroglycerine gel immersed in water, so that the explosive is capable of propagating an explosion with a detonation rate of 6000 m/sec, under water at depths as great as 2750 ft. According to J. Taylor and Gay [4] this phenomenon may be due to the reflection of the shock wave at the interface between the explosive and the sensitizing powder, an effect which occurs only when the latter is compressed above a certain minimum density. This has been exploited in the design of explosives for deep seismic explosions.

TESTS FOR MINING EXPLOSIVES

Any explosive which is intended for use in mines has to satisfy certain requirements and to ensure overall safety. All mining explosives, both for coal and rock must be subjected to the tests before being licensed for use. The tests vary from one country to another. Those described below are based mainly on methods applied in Poland.

TRANSMISSION OF DETONATION

To examine this property of explosives, it is necessary to determine the maximum distance between two cartridges (weighing 100 g each, 30 mm dia.) at which detonation will propagate from the cartridge fitted with a No. 8 detonator to the second cartridge which has no detonator. This distance should not be less than 3 cm, and

for special permitted explosives 4 cm; for ammonium nitrate explosives it is usually 4–8 cm and for dynamites it is more. Sometimes the transmission of detonation is expressed in terms of units, based on the calibre of the cartridge (e.g. 32 mm).

SENSITIVENESS TO DETONATION

To determine the sensitiveness to detonation 3 cartridges of explosive each weighing 75 g and 25 mm dia., or 4 cartridges each weighing 100 g and 30 mm dia. may be used. The cartridges are set out in a row so that they touch each other. One of the end cartridges is then detonated by the weakest possible detonator. The explosives tested should be detonated completely under these conditions by a weak detonator*. The weakest detonator producing the detonation of the above mentioned cartridges is characteristic to the sensitiveness to detonation of a given explosive.

Testing transmission of detonation and sensitiveness to detonation is intended to establish whether or not a given explosive ensures complete detonation in a shothole. An incomplete detonation is always undesirable since it involves a considerable waste of time and effort and may cause an accident during subsequent shots. Both tests are always employed as inspection tests during production. Freshly manufactured explosive should not be used in these tests, since much better results are obtained after a few days' storage. Thus, according to T. Urbański's experiments [68], the permitted explosive Bradyt F (p. 475) initially gives a transmission of detonation value of 14–15 cm. The next day, the same cartridges give values not exceeding 7 cm. This occurs because the freshly-mixed explosive contains a considerable quantity of air which greatly facilitates the transmission of detonation. After a few days or even a few hours, when the excess of air has escaped, the transmission of detonation deteriorates. These changes in the explosive, however, are not so great as to affect the rate of detonation and expansion in the lead block.

In dynamites and in blasting gelatine, containing a large amount of nitroglycerine gelatinized with collodion cotton, the changes in properties caused by the presence of air persist for a very long period of time (often about a year) since the air dispersed in the viscous colloid of blasting gelatine remains there much longer than in explosives with a powdery consistency. E.g. blasting gelatine, containing 91% nitroglycerine and 9% collodion cotton gives a lead block expansion of 580 cm³ immediately after mixing and 545 cm³ two days later. After longer storage (more than a month) this figure may fall to 500 cm³ or to even less.

The rate of detonation undergoes similar variations. E.g. dynamite consisting of 62.5% nitroglycerine, 3.5% collodion cotton, 28% potassium perchlorate and 6% woodmeal detonates with a rate of 7000 m/sec immediately after mixing. In

* To determine the sensitiveness to detonation of mining explosive in some countries (including Poland) special standard detonators have recently been introduced, containing 0.05, 0.1, 0.15, 0.20 g etc. of silver azide. The stronger contains 0.60 g of silver azide or an equivalent quantity of lead azide.

six months the rate of detonation may decrease to 2750 m/sec. If the explosive is kept in warm premises the rate may decrease still more—up to 1800 m/sec. If the cartridges harden due to the setting of ammonium nitrate or potassium chlorate, transmission of detonation becomes worse and detonations may be impaired.

An explosive intended for tests on the transmission and rate of detonation must therefore be seasoned for at least 24 hr.

With dynamites the tests should be repeated after a few days and then after a few weeks.

The detonators employed for these tests should be reliable and their initiation strength must be checked.

It should be pointed out that the transmission of detonation depends not only on the composition of the explosive and the previously mentioned factors but also on the diameter of the cartridges, their confinement and their density.

The transmission increases with the diameter up to a certain diameter at which it becomes constant.

An investigation of the probability of transmission of detonation as a function of the diameter of the cartridge was carried out by Hino [69]. This is depicted by the diagram in Fig. 143.

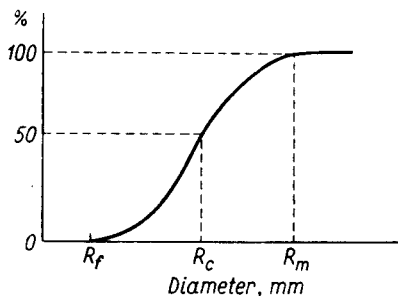

FIG. 143. Probability of detonation (in %) as a function of cartridge diameter, according to Hino and Yokogawa [59]. R_f —diameter which does not give any transmission of detonation; R_c —“critical” diameter (50% probability of transmission of detonation); R_m —minimum diameter which gives 100% probability of transmission of detonation.

The transmission of detonation in a confined space (in a tube or shothole) is higher than in the open air. E.g. an ammonium nitrate explosive with 4% nitroglycerine which ordinarily has a transmission value of 10–15 cm, in a mortar gives the value 19–23 cm, according to T. Urbański [70]. This author studied change of transmission as a function of density. The results for ammonium nitrate explosives are given in the diagram in Fig. 144.

The decrease in transmission values with density beyond a certain value (density higher than 1.1) seems to be of particular significance. T. Urbański showed as early as 1926 [70] that the shock wave produced by detonation of an explosive can move along a shothole, or a mortar, at a rate higher than the rate of detonation (e.g.

for the rate of detonation of 3220 m/sec in a tube 35/42 mm, the rate of the shock wave was 3830 m/sec). The shock wave may "dead" press the cartridges to a degree which renders their transmission of detonation difficult.

According to Hino and Yokogawa [59] an addition of surface active agents (0.5–1%) to mixtures of ammonium nitrate with liquid coal-tar improves the trans-

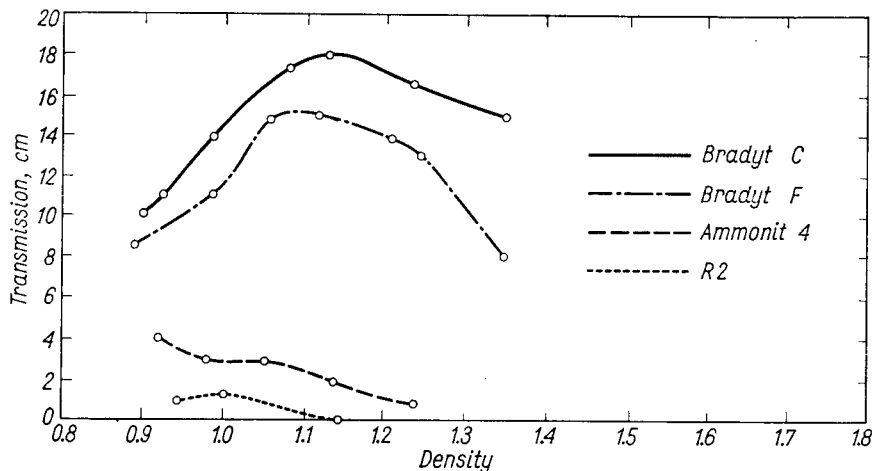

FIG. 144. Transmission of detonation as a function of density, according to T. Urbański [70].

mission of detonation and increases the rate of detonation. These authors assume that the surface active agents increase the rate of reaction between the ammonium nitrate solid phase and the coal-tar liquid phase.

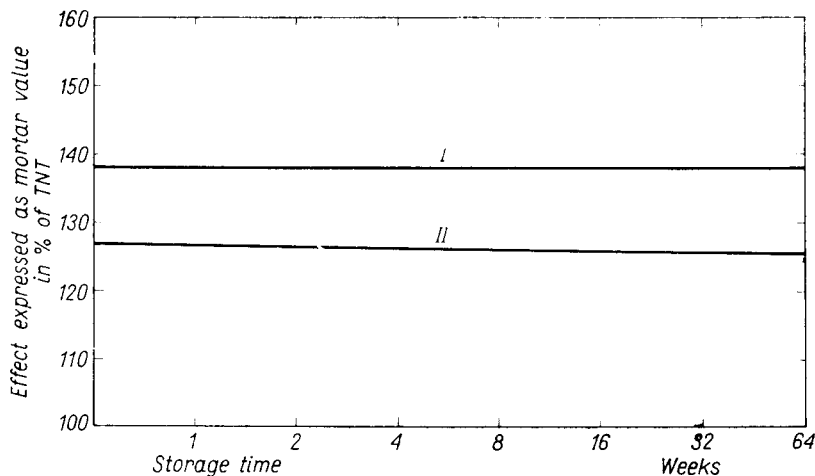

FIG. 145. Change in the power of explosives on storage [71]; I—ammonia gelatin, type B with 35% NG; II—ammonium nitrate explosive, type II with 6% NG and 76% NH_4NO_3 .

Wetterholm [71] gave a number of diagrams illustrating the change of explosive properties of mining explosives during storage.

Figure 145 suggests a very small reduction in the power of dynamite and ammonium nitrate explosives on storage, measured in a ballistic mortar. Figure 146 indicates the change in the transmission of detonation during storage. The decline in trans-

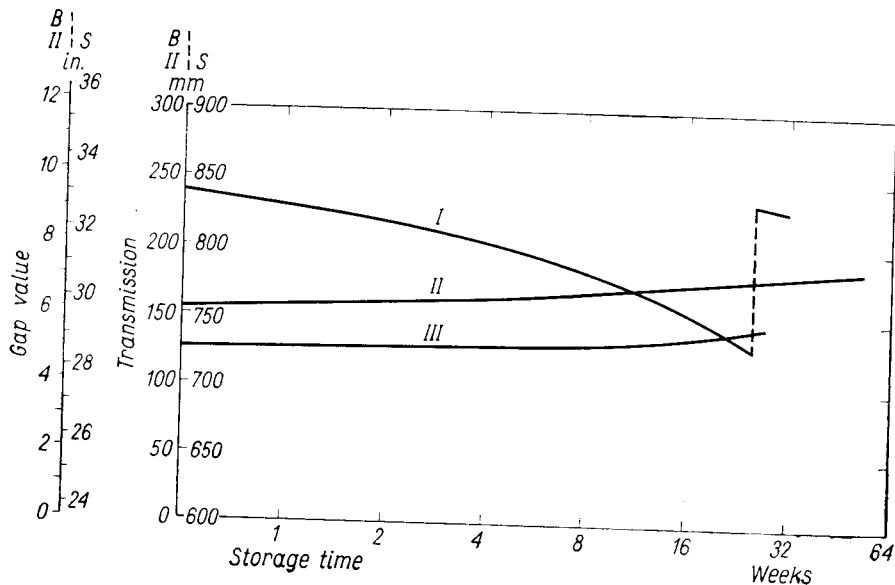

FIG. 146. Change in the transmission of detonation of explosives on storage [71]; *I*—ammonia gelatin, 1 in. (25 mm) dia., type B with 35% NG; *II*—ammonium nitrate explosive, 1 in. (25 mm) dia., type II with 6% NG and 76% NH_4NO_3 ; *III*—semi-plastic explosive, $1\frac{3}{16}$ in. (30 mm) dia., type S with 54% NG.

mission of a gelatine explosive (35% nitroglycerine) can be halted and restored by re-kneading the explosive. The change in transmission of detonation with temperature is depicted on another diagram (Fig. 147). The change of the rate of detonation of these explosives on storage is given in Fig. 148. Wetterholm also gives the value of the rate of detonation at various temperatures (Table 107).

TABLE 107

Temperature °C	Ammongelatine (35% NG) m/sec, No. 8 detonator	Ammonium nitrate explosive (6% NG) m/sec, No. 8 detonator
-25	2300	3350
0	2450	3350
+35	2700	3600

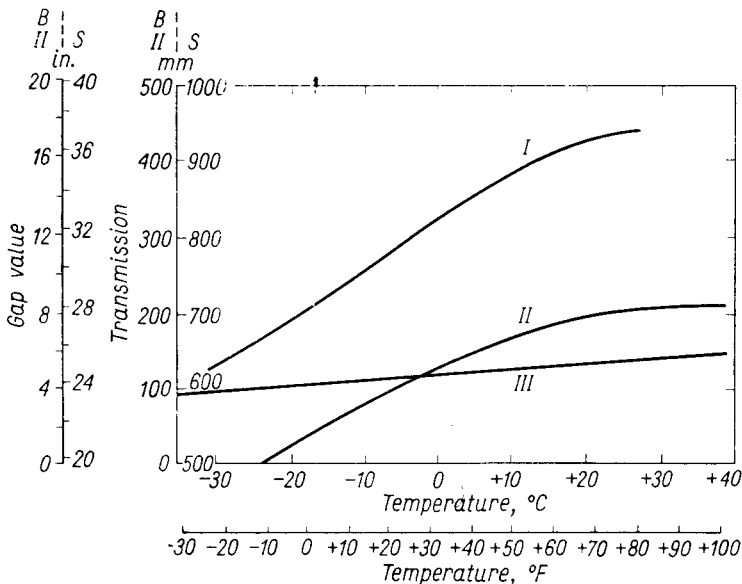

FIG. 147. Change in the transmission of detonation of explosives with temperature [71]; *I*—semi-plastic explosive, type S with 54% NG; *II*—ammonium gelatine, type B with 35% NG; *III*—ammonium nitrate explosive, type II with 6% NG and 76% NH_4NO_3 .

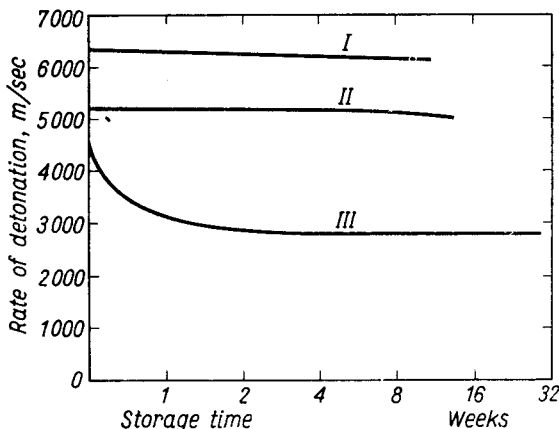

FIG. 148. Change in the rate of detonation of explosives on storage [71]; *I*—ammonia gelatin, iron tube 1 in. (25 mm) dia., type B with 35% NG; *II*—ammonium nitrate explosive, iron tube 1 in. (25 mm) dia., type II with 6% NG and 76% NH_4NO_3 ; *III*—ammonium gelatine, cardboard tube $1\frac{9}{16}$ in. (40 mm) dia., type B with 35% NG.

POWER OF EXPLOSIVES

The power of explosives is determined in a conventional manner. The most usual test is the determination of the lead block expansion and the rate of detonation. In some countries the crushing of lead and copper cylinders is determined.

In Anglo-Saxon countries a test in a ballistic mortar is also used. Tests for explosive power should be repeated occasionally for inspection purposes in production.

SAFETY TESTS WITH METHANE AND COAL-DUST

Explosives for use in coal mines containing methane or ignitable coal-dust must pass a test in a testing gallery. Different procedure is used in different countries. General data on galleries and methods of testing are summarized in Table 108.

Experimental gallery in Poland

The experimental gallery for testing explosives for use in the mining industry (Fig. 149) is a wrought-iron tube, circular in cross-section, 44.2 m long and 2.0 m in inner diameter. One end of the tube is open, while the other is closed with a concrete block. There is a cavity inside the concrete block in which a steel mortar is mounted (Fig. 150). The cavity is connected through the safety valve, vent shaft and air damper with a powerful electric ventilator for airing the gallery after the shot. The safety valve and air damper close the vent shaft and protect the ventilator from accidental damage when firing takes place.

Throughout the length of the gallery there is a floor of sheet iron with an empty space below filled with concrete except for the first three meters from the closed end, where the heating pipes are situated.

Inside the gallery, at a distance of 3.4 m from the closed end a ring is fixed to which a paper partition is fastened so as to form a chamber of 10 m³. In the chamber a mixture of methane and air is prepared. In winter this is heated to a temperature of above 0°C by steam in the heating pipes beneath the floor.

In the wall of the gallery facing the observation post there are observation windows at intervals of 1 and 2 m along its whole length, through which the course of firing is watched.

Between the first windows at the firing end there are apertures for the firing leads and arrangements for measuring the temperature inside the gallery.

After the cables have been laid, the paper partition is fastened in place, and the cables are connected through the short-circuiting unit with the observation post.

The concrete block closing the firing end is situated in a compartment in which the methane dispensers and the ventilators are located.

At a distance of about 10 m from the gallery, half way along its length, an observation post is located, from which the charges are fired and the results observed.

In Poland the following standards established by Cybulski have been in force since 1950. Tests are made with cartridges 32 mm dia., placed in a mortar of 50 mm dia., unstemmed. When testing permitted explosives* in the presence of firedamp,

* i.e. safe towards firedamp and coal-dust.

TABLE 108

Country	Locality	Dimensions of gallery		Capacity of gas chamber m	Gas		Shothole in the mortar length diameter cm mm	Stemming	Dia- meter of charges mm
		length m	diameter m		type %	concen- tration %			
Belgium Czechoslovakia	Pâturages Ostrava	20	1.6	10	fire damp	9	50	no stemming	30
		24	1.8/1.4 (elliptical)	10	fire damp	8-9	60		55
France	Verneuil	12	2.0	15.7	fire damp	8-9	22	stemming with a steel disk	38
		12	2.0	22		day temperature	34	stemming or no stemming	55
Great Britain	Buxton	15	1.5	10	natural gas	9±0.25	120	no stemming	37
						*			
Japan Germany	Nagata Derne Freiburg	34	1.55	6.8	methane	9	120	no stemming	32
		25	1.35 1.8 (elliptical)	10	methane	8-9.5	60	no stemming	55
Poland	Mikołów Institute of Mining Safety Bruceton	44	2.0	10 or 20	methane	8-9.5	70 or 120	no stemming	33
U.S.A.		30.5	1.9	17.8	natural gas	8 and 4**	55	1 pound of dry clay or no stemming	32
U.S.S.R.	Makeyevka	a number of galleries	1.5-1.8	10-11	methane	8-10	90*	stemming of moist clay	31-32

* The use of a mortar is permissible until the capacity of the shothole increases less than 50% in comparison with the initial capacity.

** 40% used only in conjunction with added coal-dust on shelves and on the floor of the gallery.

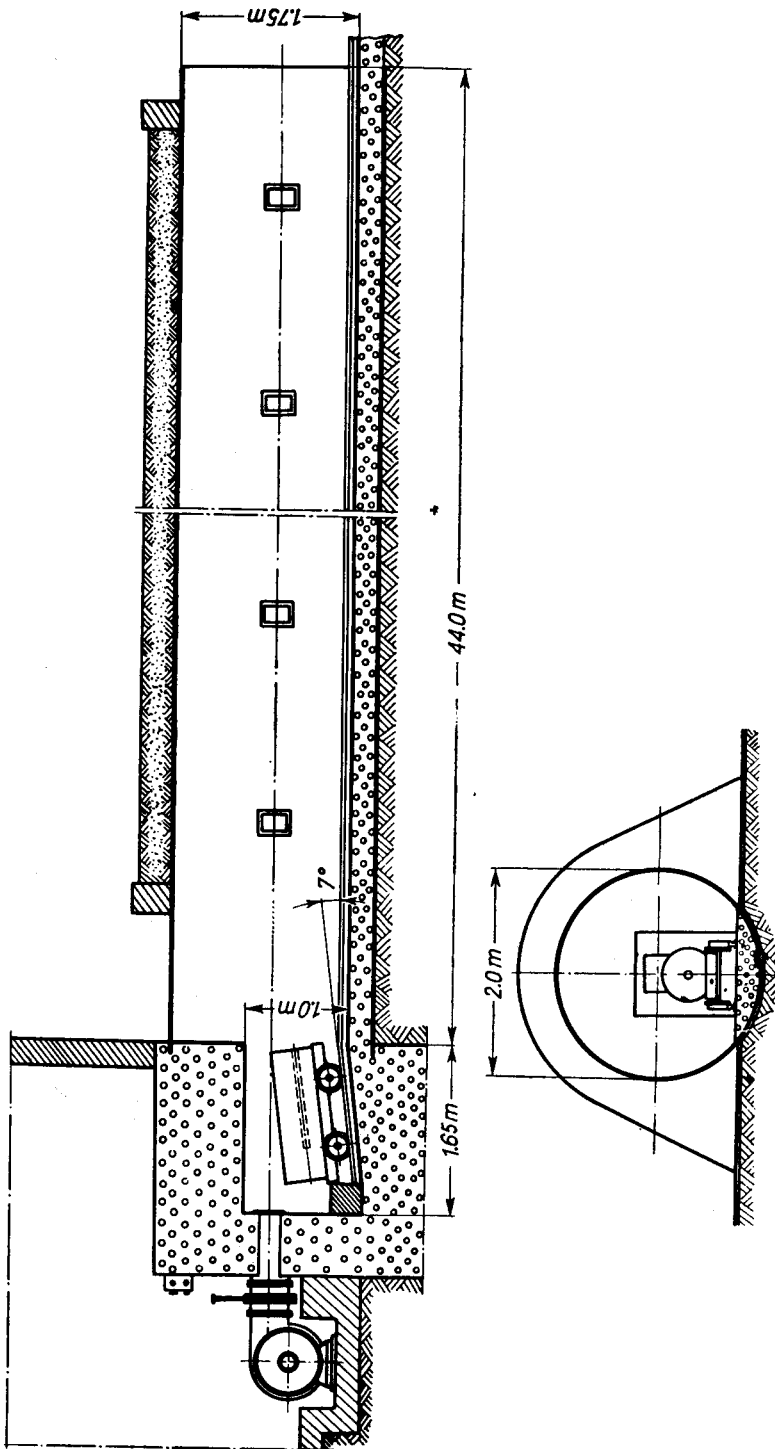

FIG. 149. Diagram of the experimental gallery at Mikołów (Poland).

10 shots, each of 500 g, are fired with the detonator placed at the front of the charge (i.e. initiated directly). The content of methane in the air is 8–9.5%. With special permitted explosives the requirements are much more stringent. The test involves 1 kg of explosive, fired by means of a detonator placed at the rear of the charge (i.e. inversely initiated). The number of shots should not be less than 20.

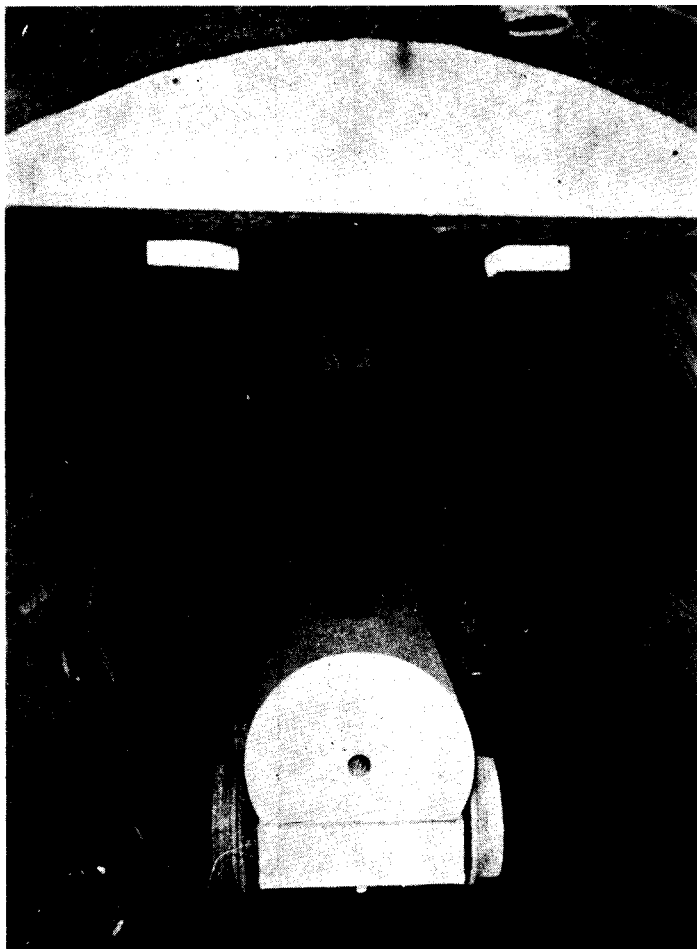

FIG. 150. The closed end of the experimental gallery simulating a coal-face, at Mikolów (Poland).

When testing the safety of normal and of permitted explosives (i.e. permitted Metanits and Karbonits) in the presence of coal-dust 10 shots, each of 500 g, directly initiated, are fired. A cloud of coal-dust is formed by firing small charges (5–7 g) of permitted explosive in bags with coal-dust, suspended in the explosion chamber of the gallery. This creates the most favourable conditions for the ignition of coal-dust, and is therefore a most rigorous test for the explosive. The shots in the bags are fired simultaneously, just 0.5 sec before the test shot.

The classical method of firing explosives in a testing gallery with the charge inside the mortar does not present a true picture of the safety of explosives towards coal-dust since the explosives commonly used fail to ignite coal-dust under such conditions. The angle shot mortar (Fig. 138) is therefore sometimes used as an unofficial auxiliary test.

Special permitted explosives are tested under much more drastic conditions. As previously stated 1 kg of inversely-initiated explosive is fired creating a cloud of coal-dust. The number of test shots should not be less than 20. Safety in the presence of coal-dust is also tested by a special method worked out by Cybulski, which consists in firing two charges, each weighing 1 kg, simultaneously from two opposite mortars. The distance between the mortars is 1 m. A cloud of coal-dust is obtained as described above. The charges are inversely initiated. The number of shots is 20. The test is considered exceptionally stringent. Such tests are repeated from time to time for inspection purposes.

In addition the flashes produced when the explosive charges are fired in the air, are recorded photographically, as an auxiliary test.

Experimental gallery in U.S.S.R.

In the U.S.S.R., tests to authorize permitted explosives for use in dangerous mines are carried out according to the standard specification—GOST 7140-54.

Each lot of the explosive manufactured is tested by drawing samples from 2% of the boxes.

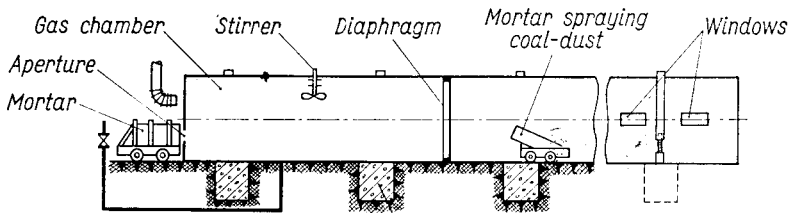

FIG. 151. Diagram of the testing gallery in the U.S.S.R., according to GOST 7140-54.

A testing gallery is shown diagrammatically in Fig. 151. The wall which closes the gallery is fitted with an aperture 300-400 mm dia., to which the mortar is brought on a truck.

The testing of explosives for use in the presence of methane-air mixture is carried out by firing a charge of 600 g. For those used in the presence of coal-dust a charge of 700 g is used.

Three tests are carried out on each lot of explosives intended for use in methane-air mixture and two tests on each lot for use in the presence of coal-dust; in one of these no coal-dust is present in the mortar, in the other 100 g of coal-dust are placed in the bore, most of it between the charge and the mortar's mouth.

Should the methane-air mixture or the coal-dust be ignited, repeat tests are carried out in duplicate on samples drawn from twice the number of boxes. If these tests again give unsatisfactory results, even only for one substance (gas or dust), the lot is rejected.

At least once a year every production plant sends samples (of not less than 60 kg each) of all permitted explosives manufactured there, to the Makeyevskii Scientific Institute of Safety in Coal Mines Research (MAKNII) for a check inspection.

Samples of permitted explosives for use in the presence of methane-air mixture or of coal-dust are tested by the MAKNIИ according to paragraph 5 of GOST 7140-54 and repeated in accordance with paragraph 6 of GOST 7140-54.

MAKNII carries out tests on experimental new substances or pilot production lots (to be authorized for handling and use) by firing 10 shots from each batch in methane-air, and 10 from each lot in coal-dust (5 with and 5 without coal-dust (100 g) in mortar).

The stemming used when testing explosives in the presence of methane is prepared as follows:

Plastic clay is dried to a moisture content of less than 5% and stemming material is made from it by mixing four parts by weight of the clay with one part by weight of water. The mixture is stirred carefully until a uniform paste is obtained.

50-55 g of clay so prepared containing 20-25% water is pressed into a cake 10 mm wide and 55 mm dia. to make the stemming (Fig. 152).

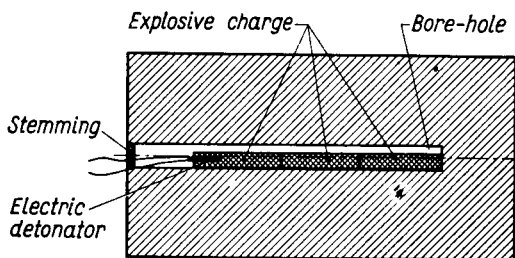

FIG. 152. Charged mortar with clay stemming, according to GOST 7140-54.

Method of testing in the presence of methane. An explosion chamber 10-11m³ in capacity is separated by a gas-proof diaphragm within the experimental gallery.

The cartridges of explosive being tested are placed in the mortar end to end so that the charge reaches the bottom of the hole, with the last cartridge facing the mouth of the mortar not less than 5 cm away from it (Fig. 152).

A No. 8 instant fulminate-tetryl electric detonator is fixed to the cartridge next to the mouth of the mortar and the hole hermetically sealed with stemming of plastic clay.

The loaded mortar is moved through the window into the explosion chamber of the experimental gallery.

Gas (natural or synthetic methane) containing not less than 90% methane and not more than 8–10% hydrogen is introduced into the chamber.

Before firing the shot the methane–air mixture is stirred by a fan or a mixer and the methane content determined by a Sager pipette or gas analyser.

The temperature of the methane–air mixture in the chamber should lie between -10 and $+30^{\circ}\text{C}$.

Method of testing in the presence of coal-dust. Testing in the presence of coal-dust is carried out in an experimental gallery without a diaphragm. The lay-out of the explosive cartridges and the electric detonator in the mortar is the same as that described above.

The coal-dust used for the tests is obtained by milling either coal from the Makeyevskii seam of the Tchaikino-South mine, which contains 29–35% volatile matter, less than 9% ash and less than 2% moisture, or another coal of the same composition.

According to GOST 4403–48 the coal should be ground so that the residue on a No. 15 sieve is less than 10% and that more than 50% of the dust passes through a No. 16 sieve.

Coal-dust is injected into the experimental gallery by means of a spray gun 500–700 mm long with a 150–220 mm bore, loaded with 50 ± 5 g of the explosive under test. The charge is fitted with a No. 8 fulminate–tetryl electric detonator in a paper or copper tube. 6 ± 0.1 kg of coal-dust is spread over the charge.

The spray gun is placed:

at a distance of 11.5 m from the bottom of a gallery 1500 mm dia.;

at a distance of 10.0 m from the bottom of a gallery 1600 mm dia.;

at a distance of 8.0 m from the bottom of a gallery 1800 mm dia.;

and at an angle of 20° to the horizontal axis of the gallery.

The charge of the explosive being tested, weighing 700 g, is located in the mortar.

A No. 8 fulminate–tetryl electric detonator in a paper or copper tube is located in the first cartridge. Coal-dust spraying is commenced 5–10 sec before the charge of explosive being tested is initiated.

If a 700 g charge fails to ignite coal-dust under the conditions described above, the explosive is considered to be safe in the presence of coal-dust.

If any residue of the explosive is found in the bore of the mortar or in the explosion chamber, the test is considered a failure irrespective of whether or not the coal-dust is ignited.

APPLICATION OF STATISTICS TO GALLERY TESTING OF EXPLOSIVES

During World War II Dixon and Mood [72] developed a special experimental method for testing the sensitiveness of explosives to impact. The method gave a statistical estimation of the mean value. It became known as the Bruceton up-and-down method. The primary advantage of the method is that it increases the accuracy with which the mean value can be economically determined. The method requires fewer tests than other methods.

It was used for dust-explosion gallery tests on "permissible" explosives at Buxton at the S.M.R.E. by Gibson, Grimshaw and Woodhead [73]. It is now accepted in the U.S.A. as a standard procedure for determining the charge limit of a safety explosive. Figure 153 gives a general idea of the method. Usually the charge (W_{50}) giving a 50% probability of explosion of firedamp or coal-dust is determined by this method [75].

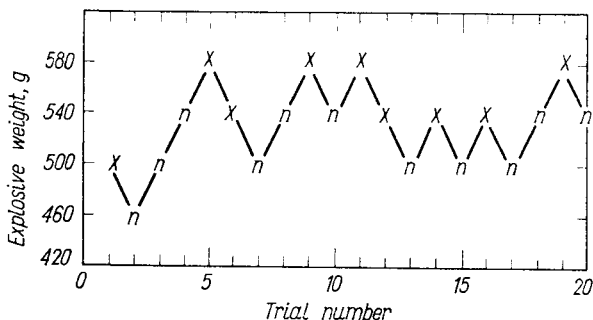

FIG. 153. Determination of incendiveness of a permitted (permissible in the U.S.A.) explosive in a firedamp atmosphere, by the up-and-down method, according to Grant and van Dolah [74].

STABILITY OF MINING EXPLOSIVES

The chemical stability of explosives depends on their ingredients. Those which do not contain nitroglycerine may be stored for long periods. Ammonium nitrate explosives must be protected against moisture and, if this is done, they may be stored for periods up to 6 months. In practice, all explosives containing nitroglycerine should be utilized fairly quickly (within 1-3 months, depending upon the regulations in force in a given country). It is very important to remember that ammonium nitrate always contains a certain amount of free nitric acid which, if not neutralized by the addition of suitable ingredients, has a deleterious effect on nitroglycerine, leading to its decomposition. Apart from chemical stability the constancy of physical properties is also of importance. E.g. cartridges of ammonium nitrate explosives often become hard and difficult to detonate and impossible to use due to the impracticability of introducing detonators into them (Vol. II, p. 459). Nitroglycerine explosives which do not contain nitroglycol or aromatic nitro compounds in a proportion sufficient to lower the freezing point may freeze at low temperatures and need to be thawed. This may involve the separation of nitroglycerine, thus creating an additional hazard (Vol. II, p. 72).

MINING EXPLOSIVES USED IN VARIOUS COUNTRIES

In the following lists the mining explosives used in the inter-war period and in current use in different countries are cited.

The lists are presented in alphabetical order:

1, Belgium. 2, Czechoslovakia. 3, France. 4, Germany. 5, Great Britain. 6, Hungary. 7, Japan. 8, Poland. 9, U.S.A. 10, U.S.S.R.

BELGIUM

In Belgium earlier mining explosives had the composition given in Table 109.

TABLE 109
BELGIAN MINING EXPLOSIVES

Ingredients	R II Centralite	B bis Sabulite	V bis Flamivore	Antigrisou Yonckite
Ammonium nitrate	62	51	59	42
Sodium nitrate	—	—	—	10
Ammonium perchlorate	—	—	—	12
Potassium perchlorate	—	10	—	—
TNT	14	15	—	14
DNT	—	—	1	—
Nitroglycerine	—	—	11	—
Nitrocellulose	—	—	0.05	—
Cellulose	—	—	4.85	—
Naphthalene	—	—	2	—
Carbon black	—	—	0.1	—
Sodium chloride	18	24	22	22
Sodium oxalate	6	—	—	—

The explosives in Belgium are now classified into 4 types, according to l'Association de Fabricants Belges d'Explosifs et le Centre de Recherches Scientifiques et Techniques pour l'Industrie des Produits Explosifs [76] (Tables 110–112).

Type I—dynamites and rock explosives. The chief ingredients of the latter are ammonium nitrate, nitroglycerine and TNT. Their rate of detonation at a density of 1.1 is about 3800 m/sec, their transmission distance 6 cm.

Type II—explosives which, when a 1400 g charge is fired in a steel mortar in an experimental gallery, fail to ignite a 9% methane-air mixture or coal-dust. They are used with an inert sheath in rock workings. Their rate of detonation is about 3300 m/sec (charge 30 mm dia.) at a density of 1.1, their transmission distance 6 cm.

Type III—the S.G.P. (Sécurité-Grisou-Poussières) explosives. These are used exclusively with an inert sheath and must not ignite methane or coal-dust in the following two tests:

- (1) A shot of 1000 g, inversely initiated, fired in a mortar without stemming;
- (2) A shot of 1400 g in an angle shot mortar fired at an angle of 90°.

Their rate of detonation at a density of 1.1 and 30 mm dia. is 3000 m/sec, their transmission distance 8 cm.

Type IV—explosives extra safe in use. Explosives in this group undergo the

most stringent tests. In an experimental gallery a 2200–2400 g charge (depending on dimensions of the gallery) must not ignite methane or coal-dust.

Mixtures of this type are represented, among others, by Bicarbite mixtures, which are not explosives strictly speaking, but are used in cartridges together with cartridges of genuine explosives, to increase their safety (p. 431).

Common blackpowder or improved "poudre H" is also used in Belgium in opencast mines. The latter contains a certain amount of ammonium nitrate and is used only in mines when large charges of explosives are used. It is initiated exclusively by a detonating fuse.

The composition of modern Belgian explosives is given below.

Type I ammonium nitrate explosives may be represented by Ruptol consisting of:

Ammonium nitrate	73%
Nitroglycerine	10%
DNT	5.5%
Cellulose	5.5%
Woodmeal	4.0%
Aluminium	2.0%

The cartridges are 22, 25 and 30 mm dia.

TABLE 110
TYPE II BELGIAN EXPLOSIVES

Ingredients	Explosives		
	C. A. Fractorite	B Ruptol	003 Sabulite
Nitroglycerine	10	10	—
Ammonium nitrate	77	74.5	80
DNT	—	4	—
TNT	10	—	14.2
Sodium chloride	—	5	—
Calcium silicide	—	—	4
Kieselguhr	1.5	—	—
Woodmeal	—	6.5	1.8
Cellulose	1.0	—	—
Metal soap	0.5	—	—
Density	1.1	1.04	1.1
Diameter (mm) (of explosive core and with sheath)	26/36	23/36	23/37
Date of approval	1958	1957	1957

CZECHOSLOVAKIA

The explosives used in Czechoslovakia over the inter-war period were similar to those used in other Central European countries.

As rock explosives Dynamites and Donarits with the same composition as German Donarit were employed (the difference between Czechoslovak and German

TABLE 111
TYPE III S.G.P. BELGIAN EXPLOSIVES

Ingredients	Explosives						
	Cooppalite	Flammivore	Nitro-boncellite	V Nitrocooppalite	Matagnite	Sabulite	B Securite
Nitroglycerine and nitroglycol	35	10	10	10	10	—	35
Nitrocellulose	1.5	—	—	—	—	—	1.5
Ammonium nitrate	21.5	58	60	60	60	58.5	23.5
Potassium perchlorate	—	—	—	—	—	5	—
Trinitronaphthalene	—	—	—	—	—	1	—
TNT	—	—	—	—	—	14	—
Sodium chloride	42	25	23	23	23	20	40
Woodmeal	—	7	7	7	7	1.5	—
Density	1.5	1.0	1.05	1.0	1.0	1.15	1.4
Diameter (mm) (of explosive core and with sheath)	30	26/36 29/40	26/36	26/36	26/36	26/36	23/36
Date of approval	1955	1955	1953	1958	1955	1957	1955

TABLE 112
TYPE IV BELGIAN EXPLOSIVES

Ingredients	Explosives			
	Arionite	Ch. 41 Char- brite	VIII Nitro- cooppalite	Bicarbite
Nitroglycerine	9.9	10	10.11	14.9
Nitrocellulose	0.1	—	0.09	0.1
Sodium nitrate	55.6	54.5	55.5	—
Ammonium chloride	34.4	34	34.3	—
Sodium hydrogen carbonate	—	—	—	85
Kieselguhr	1.5	—	—	—
Cellulose	1	—	—	—
Metal soap	—	0.5	—	—
Density	1.13	1.1	1.0	1.44
Date of approval	—	1957	1957	—

(pp. 267 and 457) Donarits was that the former contained 6% nitroglycerine and 12–16% nitroglycol).

As examples of safety explosives, Metanits may be cited (Table 113).

TABLE 113
CZECHOSLOVAKIAN PERMITTED EXPLOSIVES

Ingredients	Metanit A	Metanit N
Nitroglycerine	—	24–26
Nitrocellulose	—	0.6–1.0
Aromatic nitro compounds	6	—
Ammonium nitrate	71.5	23–27
Sodium chloride	20.5	42.8–49
Woodmeal	2	—
Calcium nitrate, 50% solution	—	2.5–3.5
Palatinol A	—	0.1–0.5
Density	0.98	1.65
Power (lead block test, cm ³)	240	168
Transmission (cm)	4	2
Rate of detonation (m/sec)	3850	5000

Rock and coal explosives with the composition tabulated below are now used (Table 114).

In addition, Gelatine-Donarit 1 (p. 455) is used as a rock explosive. TNT is also employed in opencast coal working and blackpowder is used where low power and a slow explosion giving large lumps are required.

TABLE 114

Ingredients	Rock explosives			Coal explosives	
	Gelatine	Dynamon I	Astralit I	Plastic* Metanit N	Bikarbit *
Nitroglycerine and nitroglycol	22	—	3	25	12.5
Nitrocellulose	0.8	—	—	0.8	—
Nitro compounds	—	14.1	12	—	—
Ammonium nitrate	61.9	82.9	82	25	—
Calcium nitrate, 50% aqueous solution	—	—	—	3	—
Sodium chloride	—	—	—	45.9	47
Sodium hydrogen carbonate	—	—	—	—	40.5
Woodmeal	—	2.75	2.5	—	—
Dyes	0.3	0.25	0.5	—	—
Diethylphthalate	—	—	—	0.3	—
Density	1.52	0.96–0.97	1.04	1.4	1.3
Oxygen balance (%)		+1.1	+3 to +5.5	+5.4	+0.4
Power (lead block test, cm ³)	370–390	320–355	270–280	150–170	20–25
Transmission (cm)	15–20	5	5	2–6	2–3
Rate of detonation (m/sec)	6200–6500	3900–4200	3800–4800	3200–3800	2350
Heat of detonation (kcal/kg)		902	800	902	107

* Bikarbit is often used as an active sheath. The cartridges are composed of 52% Metanit and 48% Bikarbit.

A recent addition to the list of Czechoslovakian rock explosives [77] includes Geldonarit composed of:

Nitroglycol	22.0%
Collodion cotton	0.8%
Ammonium nitrate	61.9%
Cyclonite	15.0%
Dye	0.3%

Its properties are:

Density	1.52
Oxygen balance	+6.8%
Lead block expansion	370–390 cm ³
Transmission of detonation	15–20 cm
Rate of detonation	6350 m/sec
Heat of detonation	960 kcal/kg

FRANCE

The more modern mining explosives employed in France (Table 115) do not differ in the main from those used earlier (see p. 403).

There have been modifications in explosives for coal work, in which 5% ammonium nitrate was replaced by potassium nitrate. These were called the saltpetre explosives (salpêtré).

TABLE 115

Ingredients	Explosifs couche (for coal work)		Explosifs roche (for rock work only)	
	Grisou-naphthalite couche	Grisou-dynamite couche	Grisou-naphthalite roche	Grisou-dynamite roche
Ammonium nitrate	95	87.5	91.5	70
Nitroglycerine	—	12	—	29
Nitrocellulose	—	0.5	—	1
TNT	5	—	—	—
Dinitronaphthalene	—	—	8.5	—
Charge limit	500	500	1000	1000

Apart from explosives of this kind, others similar to those commonly used in other countries, i.e. permitted explosives containing sodium chloride, have more recently begun to be used in France.

There has also been a growing interest in ammonium chloride with sodium nitrate as ingredients of mining explosives in France.

TABLE 116

GROUP I. FRENCH EXPLOSIFS COUCHE AMELIORÉS

Ingredients	Dynamites			N Type	
	Grisou-dynamite chlorurée n°15	Noburex	Explosifs grisou chlorurés n°16	N n°64	N n°65
Nitroglycerine	20	20	12.3	—	—
DNT	—	—	0.7	—	—
Dinitronaphthalene	—	—	—	1.5	—
Penthrite	—	—	—	20	12
Ammonium nitrate	20	29	33	20	35.5
Sodium chloride	58	44	49	58.5	47
Woodmeal	2	—	—	—	3.5
Urea-resin foam	—	7	—	—	2
Peat	—	—	5	—	—
<i>Properties</i>					
Density	1.3	0.8	1.0	1.3	1.25
Power* (lead block test, picric acid = 100)	41	55	50	42	55
Transmission (cm)	10–50	6–12	5–10	4–8	3–7
Rate of detonation (m/sec)	2300	2000	2100	3000	3300
Date of approval	1949	1952	1954	1949	1950

* CUP = Coefficient d'utilisation pratique.

Finally, attempts are being made to use such ingredients as penthrite and cyclonite. The most modern mining explosives employed in France are classified into four groups with regard to their safety in use:

I. Improved explosives for coal work (explosifs couche améliorés). They may be used with delay detonators provided that the delay between the first and the last shot is less than 5 sec. In particularly dangerous places short-delay detonators should be used. The minimum initial charge is 1500 g in coal and 2000 g in rock.

II. Explosives for coal work (explosifs couche). They may be used only with instantaneous detonators. The minimum initial charge is 500 g in coal and 1000 g in rock.

III. Explosives for rock work (explosifs roche).

IV. Explosives permitted only in places where safety is not an important factor (explosifs à l'usage restreint).

With regard to composition they are divided into:

Dynamites, in which nitroglycerine is the chief ingredient;

Type N explosives, in which ammonium nitrate is the chief ingredient.

The most widely used of these explosives is Grisou-dynamite chlorurée n°15.

TABLE 117

GROUP II. FRENCH EXPLOSIFS COUCHE

Ingredients	Dynamites			N Type
	Grisou-dynamite chlorurée n°1	Grisou-dynamite chlorurée n°a	Minuret	N n°7
Nitroglycerine	20.5	20.5	20	—
DNT	—	—	—	7
Ammonium nitrate	55.5	—	17	76
Ammonium nitrate of low density	—	55.5	—	—
Sodium nitrate	—	—	34	—
Sodium chloride	21.5	21.5	—	15
Ammonium chloride	—	—	22	—
Woodmeal	2.5	2.5	—	2
Urea-resin foam	—	—	7	—
<i>Properties</i>				
Density	1.25	0.90	0.85	1.0
Power (picric acid=100)	77	77	74	87
Transmission (cm)	10-40	6-20	5-15	2-6
Rate of detonation (m/sec)	3300	2500	2300	3700
Date of approval	1933	1954	1952	1933

The most extensively used of these explosives are grisou-dynamite chlorurée n°1 and N n°7.

TABLE 118
GROUP III. FRENCH EXPLOSIFS ROCHE

Ingredients	Dynamite	N type
	Grisou-dynamite roche à la cellulose ou cellamite	N n°1b grisou-naphthalite [*] roche
Nitroglycerine	30	—
Dinitronaphthalene	—	8.5
Ammonium nitrate	67.5	91.5
Woodmeal	* 2.5	—
<i>Properties</i>		
Density	1.2	1.0
Power (picric acid=100)	111	103
Transmission (cm)	10-30	2-6

Grisou-dynamite roche is in relatively wide use for blasting rocks.

TABLE 119
GROUP IV. FRENCH EXPLOSIFS À L'USAGE RESTREINT

Ingredients	Dynamites			N types				
	Dyna- mite gomme A	Dyna- mite gomme B Am	Nitro- baronite	N n°31	N n°30	N n°21	N n°0	N n°C
Nitroglycerine	92	60	22.75	—	—	—	—	—
Nitrocellulose	8	3	3	—	—	—	—	—
DNT	—	—	3	—	—	—	—	—
TNT	—	—	—	9.8	10.6	19.7	21.3	—
Dinitronaphthalene	—	—	—	—	—	—	—	12.6
Penthrite	—	—	—	2.5	—	4.9	—	—
Ammonium nitrate	—	31	69	78.5	80.2	75.4	78.7	87.4
Woodmeal	—	6	1.25	—	—	—	—	—
Aluminium	—	—	3	—	—	—	—	—
Bran	—	—	2	9.2	9.2	—	—	—
<i>Properties</i>								
Density	1.60	1.55	1.35	1.0	1.0	1.1	1.0	1.0
Power (picric acid=100)	155	145	125	138	132	123	120	111
Transmission (cm)	1-15	5-15	5-15	8-12	6-10	8-12	6-10	3-6
Rate of detonation (m/sec)	2000* 7800	2000* 7500	4200	4200	4000	5100	4200	4200

* Depending on the strength of the detonators.

Dynamite gomme B Am is much used. Explosives n° 31, 30, 21 and 0 are very little used in coal mines.

GERMANY

German mining explosives are commonly divided into rock and coal explosives, the word "wetter" being added to their name if safe towards the firedamp ("Schlagendes Wetter" or "Schlagwetter").

The following explosives are for rock:

- (1) Blackpowder type;
- (2) Dynamites;
- (3) Ammonium nitrate type;
- (4) Perchlorate type;
- (5) Chlorate type.

During the first few years after World War I these explosives were permitted for coal work if there was no methane or dangerous coal-dust in the mine. Soon, however, their use was restricted exclusively to rock work or in safe and opencast mines. Explosives of the blackpowder type (Table 120) were used in Germany even in mines with dangerous coal-dust, which led to a great catastrophe at the Heinitz mine in 1923. From then on the use of these explosives was restricted to rock work only. Some of the most dangerous explosives such as Ammonite 5 (with aluminium) were not permitted for use in rock work in coal mines but only in quarries. The most important types of German rock explosives are summarized in Tables 120 and 121.

TABLE 120
GERMAN EXPLOSIVES OF THE BLACKPOWDER TYPE

Name	Composition, %							
	Potas- sium nitrate	Sodium nitrate	Char- coal	Brown char- coal	Pitch	Sulphur	Cel- lulose	Carbon black
Sprengpulver 1	73-77	-	10-15	-	-	8-15	-	-
Sprengpulver 5	70-73	-	5-7	-	-	17-19	5-7	-
Sprengsalpeter 1	0-25	40-75	10-16	-	-	9-15	-	-
Sprengsalpeter 2	0-5	65-75	-	10-16	-	9-15	-	-
Sprengsalpeter 3	0-5	66-76	0-10	-	15-19	9-11	-	-
Sprengsalpeter 4	0-40	25-70	-	-	-	8-12	10-15	8
	and 0-3 FeSO ₄							
Sprengsalpeter 5	0-40	30-75	5-7	-	-	17-19	5-7	-

During World War II Gelatine-Donarit 1 was extensively used, as was Dynamite 1 and Ammonite 1. The composition of Gelatine-Donarit 1 was:

Nitroglycol	22%
Nitrocellulose	0.8%
TNT	5%
DNT	6%
Ammonium nitrate	55%
Sodium nitrate	10%

Woodmeal	1%
Pyrites ash	0.2%

The oxygen balance of this explosive is +3.7%, its density 1.53. Its explosive properties are:

Heat of explosion	1030 kcal/kg
Rate of detonation	6150 m/sec
Lead block expansion	380 cm ³
Transmission	10 cm

The coal explosives, safe towards methane and coal-dust, are classified into 3 groups:

- (1) Ammonium nitrate;
- (2) Semi-gelatinous;
- (3) Gelatinous.

Semi-gelatinous and gelatinous explosives are dynamites, adopted for coal work in the presence of methane and coal-dust due to their relatively high contents of "cooling" salts, mostly potassium or sodium chlorides (sometimes in the form of an aqueous solution of calcium nitrate).

Owing to the reduced sensitiveness to detonation of the ammonium nitrate coal explosives in the presence of the chlorides of alkaline metals, at least 4% nitroglycerine is added to these explosives. During World War I, when nitroglycerine was in short supply, it was sometimes replaced on the suggestion of Kast, by an admixture (5-10%) of potassium perchlorate as a sensitizing agent. The composition and properties of German coal explosives are listed in Table 122.

As can be seen, the gelatinous explosives of the Nobelite type, safe in the presence of methane, contain a small amount of calcium nitrate solution. Calcium nitrate was added to Nobelites to reduce the temperature of the flame of explosion. After World War I, small quantities of calcium nitrate in the form of a concentrated aqueous solution were added to the milled nitroglycerine powder (from the post-war surplus) used as a rock explosive. This was done to counteract dustiness; e.g. Nitroglycerinpulver 1 explosive had the following composition:

94-96%	of milled nitroglycerine powder
4-6%	of 50% calcium nitrate solution

Next Schwanke [78] published a patent in which he suggests the impregnation of woodmeal with a solution of calcium nitrate. The mixture is dried at temperatures from 90 to 130°C and compressed into tubes (resembling those of black blasting powder).

According to Chemisch Technische Reichsanstalt [79] a well-dried (64 hr at a temperature of 120°C) mixture having the composition:

Calcium nitrate	57%
Woodmeal	42%
Pyrites ash	1%

TABLE 121
 GERMAN DYNAMITES AND AMMONIUM NITRATE, PERCHLORATE AND CHLORATE EXPLOSIVES

Name	Ammonium nitrate	Sodium nitrate	Potassium perchlorate	Nitroglycerine and nitroglycol	Nitro-cellulose	Aromatic nitro compounds	Wood-meal	Various
Dynamite 1	—	25-29	—	61-63	1.5-4	—	6-9	0-2
Dynamite 2	—	25-30	—	59-61	4.5-9	0-4	3-8	—
Dynamite 3	—	44-54	—	34-39	1-6	6-10	1-6	—
Dynamite 5	—	50-74	—	16-20	0.5-2	2-12	1-6	0-12 (sodium chloride)
Ammonite 1 (Donarit 1)	67-85	Potassium nitrate	—	3-4	—	10-18	1-6	—
Ammonite 2	67-87	0-10	—	—	0-4	12-20	1-6	—
Ammonite 4	70-77	—	5-10	—	—	10-16	1-4	—
Ammonite 5 (not permitted in coal mines)	68-84	0-5	0-5	—	—	5-15	0-4	2-12 (aluminium)
Ammonite 6	82-88	—	—	3-4	—	3-8	1-6	—
Perchloratit 2	0-10	Potassium nitrate	—	—	—	—	—	—
Perchloratit 3	35-45	0-10	52-75	—	0-4	20-30	1-8	—
Chloratit 2	Potassium or sodium chlorate	—	30-40	—	—	15-20	3-8	—
Chloratit 3 (similar to Miedziankit)	50-85	—	0-20	—	—	10-20	1-5	3-5 (hydrocarbons, fats or oils)
	88-91	—	—	—	—	—	0-3	8-12 (liquid hydrocarbons with a minimum ignition temperature of 30°C)

TABLE 122
GERMAN COAL EXPLOSIVES

Name	Composition, %							Explosive properties								
	Ammonium nitrate	TNT	DNT	Nitro-glycerine	Nitro-glycol	Nitro-cellulose	Wood-meal	Sodium or potassium chloride	Calcium nitrate, 50% solution	Oxygen balance %	Heat of explosion kcal/kg	Density	Rate of detonation m/sec	Lead block expansion cm ³	Transmission cm	Charge limit
<i>Ammonium nitrate</i>																
Wetter Detonit A (1936)	72	2	—	6	—	—	2	18	—	+10.4	516	1.06	3000	220	8	600
Wetter Detonit B	72	—	2	4	—	—	3	potassium chloride 19	—							800
Wetter Westfalit A	80.5	0.5	0.5	4	—	—	1.5	sodium chloride 13	—							
<i>Semi-gelatinous</i>																
Wetter Baldurit A	50	—	2	—	12 with nitro-cellulose	—	2 + coal-dust 0.5	sodium chloride 33.5	—							
<i>Gelatinous</i>																
Wetter Nobelit A	32	—	2	—	25.4	0.6	1	36.5	2.5	+4.1	640	1.66	5750	205	6	700
Wetter Nobelit B	26.5	—	—	—	29.2	0.8	0.5	40	3	+6.2	570	1.69	5650	185		700
Wetter Wasagit A	30.5	—	—	—	27.8	0.7	{ 0.3 + agar-agar 0.7	{ 39.5 + talc 0.5	—							
Wetter Wasagit B	29.5	—	—	—	30	1	{ agar-agar 0.5	39	—							
Wetter Arit	29.0	2	—	—	29	1	—	39	—	3.9	657	1.44	5200	190	6	

gives an expansion in the lead block of 165–175 cm³ when a charge of 29–30 g is used; a charge of 46–47 g of black blasting powder gives a lead block expansion of 145–160 cm³.

The disadvantage of mixtures containing calcium nitrate lies in their high hygroscopicity, though the hygroscopicity of calcium nitrate is lower than that of ammonium nitrate. Hence more modern explosives containing calcium nitrate also contain ammonium nitrate. Such mixtures include Calcinite 1, an explosive safe towards methane, with the following composition:

35.5% of ammonium nitrate
38% of calcium nitrate
7.2% of TNT
4.8% of DNT
6% of nitroglycerine
8% of woodmeal
0.5% of pyrites ash or dark dye or pigment

The more recent list of Germany rock explosives is given in Table 123 [80].

TABLE 123

Name	Nitroglycerine and nitroglycol with collodion cotton	Ammonium nitrate	Sodium nitrate	Aromatic nitro compounds	Woodmeal	Dye
Dynamit 1 (GFR)	65	—	27	—	8	—
Gelamon 1 (GDR)	32–35	40–45	12–15	4–6	3–6	0–2
Gelamon 2 (GDR)	27–30	47–52	10–13	7–10	2–5	0–1
Ammon Gellit 2 (GFR)	25–29	57–62	—	8–12	1–2	0–2
Ammon Gellit 3 (GFR)	18–23	61–67	10–15	—	1–2	0–1
Gelatine-Donarit (GDR)	20–22	55–57	10–15	9–12	0.5–2	0–0.5
Donarit 1 (GFR and GDR)	4–6	78–81	—	12–16	2–4	0.3–0.5
Donarit 2 (GFR and GDR)	4–6	80–82	—	3–5	8–10	0–0.5

Dekamon and Ammonex (ammonium nitrate with 5–6% Diesel-oil) are also in use in the German Democratic Republic and the German Federal Republic, respectively.

At present, permitted explosives in Germany are divided into 3 classes with regard to their safety in the presence of methane and coal-dust [80, 81].

Class I safety explosives (unsheathed) should fulfil the old safety requirements,

namely that 600 g fired unstemmed in a 55 mm dia., 600 mm deep shothole in a steel mortar must not cause ignition of 9% methane-air mixture in five consecutive shots.

Class II safety explosives must fulfil new conditions when tested in an angle-shot mortar: 350 g of explosive fired in this mortar at a distance of 65 cm from the wall and at an angle of 40° must not ignite a 9% methane-air mixture. The charge is increased by increments of 25 g. The charge limit should not give an ignition in any of five consecutive shots.

Class III safety explosives must be safe in a 9% methane-air mixture when fired with the maximum number of cartridges that can be placed in a row in the 2 m long groove of the angle-shot mortar. The experiment starts with 1800 g charge. It is increased by 200 g increments. The charge limit is determined; this should not give any inflammation in five consecutive shots.

From the point of view of composition, German safety explosives are classified as formerly into three groups:

(1) Ammonium nitrate mixtures with a minimum of 4% nitroglycerine and cooling salts,

(2) Semi-gelatinous, with *ca.* 12% nitroglycol or nitroglycerine and nitroglycol and nitrocellulose.

(3) Gelatinous, with 25-30% nitroglycol or nitroglycerine and nitroglycol and nitrocellulose.

They do not differ essentially from those given in Table 122.

Interesting innovations are Wetter-Astralit and Wetter-Carbonit B (West Germany). Their composition is given in Table 124.

TABLE 124

Ingredients	Wetter-Astralit (used as an active sheath)	Wetter-Carbonit B
Nitroglycerine and nitroglycol	10	8.7 (with nitrocellulose)
Ammonium chloride	—	31.0
Potassium nitrate with tetryl	—	59.0
"Guar-meal"	—	0.95
Metal-soap	—	0.05
Aluminium hydroxide	—	0.3
Sodium chloride	65	—
Sodium hydrogen carbonate	25	—
<i>Properties</i>		
Oxygen balance (%)	0	No data available
Density	1.45	
Lead block expansion (cm ³)	22	
Rate of detonation (m/sec)	1750	
Transmission (cm)	15	
Heat of detonation (kcal/kg)	106	

In East Germany explosives trials should be completed by examination in the ballistic mortar (as in Anglo-Saxon countries).

GREAT BRITAIN

In Table 125 a list is given of explosives safe in the presence of methane and coal-dust (Permitted Explosives) used in Great Britain after World War I.

According to Cybulski [82] Polar Viking explosive with a density of 1.01 has the following rates of detonation depending on the test conditions:

unstemmed, charge 22 mm dia.	1930 m/sec
unstemmed, charge 44 mm dia.	2505 m/sec
in a steel tube 31.7/38 mm	3580 m/sec

The mining explosives in Great Britain are known by conventional names based on their composition. They may be divided into the following groups according to their chemical composition:

Dynamites, gelatine dynamites or gelatines—explosives with high contents of nitroglycerine. In the second group collodion cotton is used to form a gel with nitroglycerine.

Gelignites—plastic explosives with a lower content of nitroglycerine than dynamites and formerly including potassium nitrate as an oxidizing agent; this has gradually been superseded by sodium nitrate. The presence of sodium nitrate in explosives is indicated by the letters "N.S.", e.g. N.S. Gelignite.

In all explosives containing ammonium nitrate the names mentioned above are preceded by the prefix "Ammon", e.g. Ammon Gelatine Dynamite, Ammon Gelignite etc.

"Sheathed explosives" with an inert sheath, usually containing sodium hydrogen carbonate, are also employed. After World War II "Eq. S" explosives were introduced. These have already been mentioned (p. 429).

Under The Coal Mines (Explosives) Act 1951, Statutory Instruments No. 1675: 1951 states that all mining explosives used in Great Britain are divided into two groups with regard to their safety in use:

Non-permitted, for ordinary use where special safety precautions are not required (Table 126).

Permitted, which have passed special statutory tests as safety explosives, for use in coal mines, where methane-air mixtures or inflammable coal-dust are likely to be present.

In 1957 the National Coal Board [83] centralized the purchase of permitted explosives in Great Britain and introduced standardization of composition, cartridge sizes etc.

The testing gallery at the Ardeer factory of Imperial Chemical Industries Ltd., which is identical with the Official Home Office Testing Gallery, is shown in Fig. 154 and the testing mortar in Fig. 155.



FIG. 154. Experimental gallery at I.C.I.'s Ardeer factory, according to J. Taylor and Gay [4] (a replica of Home Office Testing Gallery).

The free suspension test and break gallery, described previously, are shown in Figs. 135, 136 and Fig. 140, respectively.

The Buxton Test, often called the Home Office Test, was introduced in 1932 and is at present the British Official Gallery Test.

When testing in the presence of firedamp two series are fired:

- (1) Five shots of 8 oz each, unstemmed;
- (2) Five shots of 28 oz each, stemmed with a 1 in. clay plug;

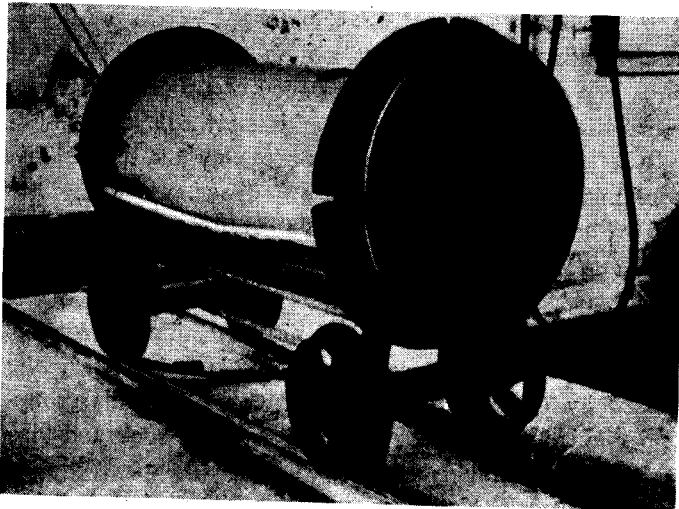

FIG. 155. Gallery mortar at I.C.I.'s Ardeer factory, according to J. Taylor and Gay [4].

For testing behaviour in coal-dust:

(3) Five shots of 28 oz are fired into a coal-dust suspension each stemmed with a 1 in. clay plug.

The permitted maximum shot-firing charge in dangerous mines was made the same for all explosives, i.e. 28 oz in any one shothole, but an exception is made in the case of certain low density explosives, where the maximum permitted charge is 18 oz.

The explosive has to satisfy certain requirements concerning sensitiveness to propagation of detonation.

A new test was introduced in 1953 for new types of permitted explosives: Eq. S. and sheathed explosives (see p. 429). For testing in a gas mixture it specifies:

(1) Five shots, each of 20 oz inversely initiated without stemming. (In sheathed explosives the charge includes the sheath.)

(2) Five shots directly initiated and stemmed with a 1 in. clay plug. For Eq. S. each shot is 36 oz and for sheathed explosives each shot is 28 oz (18 oz for low-density explosives.)

(3) The test applied for sheathed explosives only consists of five shots, each of 8 oz directly initiated, and fired unstemmed. (The weight does not include the sheath.)

For testing in a coal-dust suspension it specifies:

(4) Five shots, each of 20 oz inversely initiated are fired without stemming. (In sheathed explosives the charge includes the sheath.)

No ignition must occur with any shot. Since 1962 a new test was adopted. It involves mortar shots into gas, allowing no more than 13 ignitions out of 26 shots.

Modern Permitted Explosives used in Great Britain are divided into five groups.

I. TNT-Ammonium nitrate powders. These do not contain nitroglycerine. A typical representative of this group is Douglas Powder. Sheathed Douglas Powder was replaced by Unirend, where the equivalent weight of sodium hydrogen carbonate in the sheath was replaced by sodium chloride which was incorporated in the explosive. The safety of freely suspended cartridges is much less than that normally obtained with similar explosives containing nitroglycerine.

According to J. Taylor and Gay [4] this is probably due to a relatively high rate of detonation of mixtures manufactured in an edge-runner mill. The influence of edge-runner mixing on rate of detonation has already been discussed.

Explosives of this group are used for general coal work. They are medium to low water-resistant.

II. Nitroglycerine gelatine explosives. The nitroglycerine content (25% and over) and density (*ca.* 1.5) are high. A typical example is Polar Ajax. Sheathed Polar Ajax was replaced by Unigex and Unigel. Explosives of this group possess the highest power per unit volume. They are used for hard rock and blasting in hard coal or anthracite. They are highly water resistant.

III. Nitroglycerine semi-gelatinous explosives. The nitroglycerine content is *ca.* 15%, and density *ca.* 1.1. They are used for dealing with fairly hard coal. They

TABLE 126
COMPOSITION AND PROPERTIES OF SOME TYPICAL BRITISH NON-PERMITTED EXPLOSIVES (ACCORDING TO J. TAYLOR AND GAY [4])

Ingredients	Explosives					
	Ammonium nitrate powder	Ammonal	Ammon gelatine dynamite	Ammon gelignite	Semi-gelatine	Nitroglycerine powder
Nitroglycerine and nitroglycol	—	—	33.0	25.7	15.0	10.0
TNT	—	12	—	—	—	—
Nitrocellulose	—	—	1.3	0.9	0.3	—
Ammonium nitrate	92	83	59.2	57.8	78.7	80.0
Carbonaceous material	8	—	6.5	5.8	6.8	10.0
Aluminium	—	5	—	—	—	—
Inert ingredients	—	—	—	9.8	—	—
<i>Properties</i>						
Density	1.15	1.1	1.5	1.5	1.2	1.0
Power (as % of that of blasting gelatine)	81	88	90	78	82	78
Physical form	powder	powder	rubbery plastic	plastic	cohesive	powder
Blasting uses in:	opencast work large diameter cartridges	quarries dry to damp conditions	hard rock	hard rock	average rock	quarries dry conditions

show medium water resistance. A typical example is Dynobel No. 2. An Eq. S. explosive equivalent to sheathed Dynobel is Unibel.

IV. Nitroglycerine powders. They contain *ca.* 10% nitroglycerine which is not gelatinized. The density is *ca.* 1.0. A typical example is Polar Viking. Its sheathed Eq. S. Explosive is Unifrax.

They are used for work with soft coal. They possess medium-low water resistance.

TABLE 127

COMPOSITION AND PROPERTIES OF SHEATHED PERMITTED EXPLOSIVES AND CORRESPONDING EQ. S. EXPLOSIVES (ACCORDING TO J. TAYLOR AND GAY [4])

Ingredients	Explosives			
	Sheathed Polar Ajax	Unigel	Unigex (initial)	Unigex (modified)
Low-freeze nitroglycerine	27.5-25.5	28.3-26.3	17.7-15.7	18.0-16.0
Nitrocellulose	1.1-0.1	1.4-0.4	1.1-0.1	-
Nitrotoluene	2.8-0.8	2.2-0.2	-	-
TNT	-	-	-	-
Ammonium nitrate	42.0-39.0	32.5-29.5	-	75.4-42.4
Sodium nitrate	-	-	46.5-49.5	-
Sodium chloride	25.5-23.5	30.3-28.3	-	27.7-25.7
Ammonium chloride	-	-	30.0-28.0	-
China clay	3.5-1.5	5.3-3.3	5.0-3.0	4.7-2.7
Woodmeal	-	-	3.0-1.0	3.7-1.7
Wheat flour	-	-	1.5-0.5	1.5-0.5
Oat husk meal	4.5-2.5	2.4-0.4	-	-
Diammonium phosphate	-	1.1-0.1	-	-
Acid Magenta	0.05-0.001	0.1-0.001	-	0.5-0.005
A. S. No. 2	0.01-0.001	0.01-0.001	-	0.01-0.001
Alcohol	0.5-0.0	-	-	-
Calcium sulphate	-	-	-	4.7-2.7
Sodium carboxymethyl cellulose	-	-	1.5-0.5	1.1-0.1
Calcium stearate	-	-	1.1-0.1	1.1-0.1
Barytes	-	5.3-3.3	-	-
Volatile matter	2.0-0.0	2.0-0.0	2.0-0.0	2.0-0.0
Gallery tests	Charge limit	Charge limit	Charge limit	Charge limit
Suspended in 9% methane-air (oz)	10-12		10-12	12
Fired from 47 in. bore mortar into gallery 9% methane-air (oz)	28	24	28	20-28
Density of unsheathed cartridge	1.12	1.7	1.3	1.15
Power (as % of that of blasting gelatine)				
unsheathed	62	44	42	<i>ca.</i> 40
sheathed	43	-	-	-

V. Nitroglycerine low-density powder. This is a modification of Group IV. Low density (*ca.* 0.7) is obtained by incorporating vegetable fibre or peat. A low density form of ammonium nitrate and sodium chloride may also be used. A 1 Roundkol is an example of an explosive of this group. Sheathed Roundkol has been replaced by Unikol. They are used for soft coal, for maximum lump production. Their water resistance is the same as that of Group IV.

TABLE 128

COMPOSITION AND PROPERTIES OF SHEATHED PERMITTED EXPLOSIVES AND CORRESPONDING EQ. S. EXPLOSIVES (ACCORDING TO J. TAYLOR AND GAY [4])

Ingredients	Explosives			
	Sheathed Polar Dynobel No. 2	Unibel	Sheathed Douglas Powder	Unirend
Low-freeze nitroglycerine	16.0-14.0	12.4-10.4	-	-
Nitrocellulose	1.1-0.1	1.1-0.1	-	-
Nitrotoluene	2.2-0.2	1.3-0.3	-	-
TNT	-	-	16.0-14.0	12.7-10.7
Ammonium nitrate	64.0-61.0	50.0-47.0	70.5-67.5	52.1-49.1
Sodium chloride	16.2-14.2	36.9-33.9	17.0-15.0	39.2-36.2
China clay	1.25-0.25	-	-	-
Woodmeal	6.0-4.0	4.8-2.8	-	-
Acid Magenta	0.05-0.01	0.05-0.01	0.05-0.01	0.1-0.001
A. S. No. 2	0.01-0.001	0.01-0.001	0.01-0.001	0.01-0.001
Volatile matter	2.0-0.0	2.0-0.0	2.0-0.0	0.5-0.0
Gallery tests	Charge limit	Charge limit		
Suspended in 9% methane-air (oz)	8-12	24-30	-	-
Fired from 47 in. bore mortar into gallery containing 9% methane-air (oz)	30	30	-	-
Density of unsheathed cartridge Power (as % of that of blasting gelatine):	1.15	1.15	1.15	1.2
unsheathed	66	42	56	42
sheathed	43	-	43	-

Recently Imperial Chemical Industries Ltd. developed a class of explosives known unofficially as "ultra-safe". The general principle of these compositions is that they contain a higher proportion of cooling salts, ground to a finer size, than is customary with other permitted explosives. They have proved considerably safer than any other permitted explosive.

However, increased safety has been accompanied by considerably reduction in power. In hard material the results were poor, but firing by delay detonators gave

TABLE 129

COMPOSITION AND PROPERTIES OF SHEATHED PERMITTED EXPLOSIVES AND CORRESPONDING EQ. S. EXPLOSIVES (ACCORDING TO J. TAYLOR AND GAY [4])

Ingredients	Explosives			
	Sheathed A 1 Rounkol	Unikol	Sheathed Polar Viking	Unifrax
Low-freeze nitroglycerine	11.0-9.0	11.0-9.0	11.5-9.5	13.2-11.2
Ammonium nitrate	57.0-54.0	37.1-35.1	72.2-69.2	51.4-48.4
Sodium nitrate	11.0-9.0	14.5-12.5	-	-
Sodium chloride	13.0-11.0	31.9-29.9	11.0-9.0	32.0-29.0
Woodmeal	-	-	9.8-7.8	-
Plant fibre	12.5-10.5	11.0-9.0	-	8.2-6.2
Diammonium phosphate	0.5-0.0	0.5-0.0	-	1.1-0.1
Resin	0.5-0.0	0.5-0.0	-	1.1-0.1
Acid Magenta	0.1-0.05	0.1-0.05	0.05-0.01	0.05-0.005
A. S. No. 2	-	-	-	0.01-0.001
Gallery tests	Charge limit	Charge limit	Charge limit	Charge limit
Suspended in 9% methane-air (oz)	8	8	8	8
Fired from 47 in. bore mortar into gallery containing 9% methane-air (oz)	28	28	24	24
Density of unsheathed cartridge	0.7	0.8	0.98	0.8
Power (as % of that of blasting gelatine):				
unsheathed	61	39	66	46
sheathed	38*	-	47	-

satisfactory results. Their production and use still seems to be at the experimental stage (Wildgoose [84]). The new classification [98] includes: P-1 ordinary permitteds, P-2 sheathed permitteds, P-3 Eq. S., and P-4 the new class.

HUNGARY

The composition of coal mine explosives manufactured and used in Hungary is given in Tables 130 and 131.

Dynamite explosives of novel type ("Nidin") with nitroglycerine and nitroglycol mixtures seem to be particularly popular.

Ammonium nitrate explosives, both rock and permitted types, do not differ from those generally used in Central Europe.

JAPAN

As in European countries the development of explosives in Japan has had a chequered history. By the end of the nineteenth century dynamites and gelignites were used in mines. In 1899 a dreadful explosion occurred at Toyokuni resulting

TABLE 130

HUNGARIAN DYNAMITE TYPE EXPLOSIVES

Ingredients	Ammon- dinamit	Nidin 33	Nidin 40	Nidin 50	Nidin 60	Nidin 80
Nitroglycerine	30±1	—	—	—	—	—
Nitroglycerine and nitroglycol	—	33±0.5	40±0.5	50±0.5	60±0.5	80±0.5
Collodion cotton	1.25±0.1	1.5±0.2	2±0.2	3.1±0.2	4±0.2	7±0.3
Nitrotoluenes	3.75±0.1	0±0.3	—	—	—	—
TNT	5±0.5	—	—	—	—	—
Woodmeal	1±0.1	2±0.3	4.5±0.3	3.7±0.2	5.5±0.2	2±0.2
Ammonium nitrate	58.8±1.5	57.6±1	51.8±1	42.5±1	31.8±1	—
Sodium nitrate	—	—	—	—	—	10.3±0.5
Magnesium oxide	0.6±0.02	0.3±0.01	0.3±0.01	—	—	—
Aluminium hydroxide	0.6±0.02	0.1±0.01	—	—	0.2±0.02	0.2±0.02
Ferric oxide	—	0.3±0.01	0.3±0.01	0.3±0.01	0.3±0.02	0.3±0.01
Sodium hydrogen carbonate	—	—	0.1±0.01	0.4±0.01	0.2±0.02	0.2±0.01
Glycerol	—	1.2±0.2	—	—	—	—
Dibutylphthalate	—	—	1±0.2	—	—	—
Density	1.4±0.2	1.42±0.2	1.5±0.2	1.48±0.2	1.54±0.2	1.56±0.2
Oxygen balance (%)	+0.38	+1.68	+2.6	+4.8	+1.61	+0.3
Lead block expansion (cm ³)	415±20	390±20	370±20	420±20	420±20	480±20
Transmission of detonation (cm)	7±2	7±2	7±2	7±2	7±2	10±2
Rate of detonation (m/sec)	5600±200	5500±200	5800±200	5900±200	6100±200	6600±200
Heat of detonation (kcal/kg)	1160	1140	1180	1240	1345	1270

in the loss of 210 lives. Further great catastrophes ensued in 1903, 1906 and 1907, the last one (also at Toyokuni) causing the death of 365 people. It was caused by the explosion of coal-dust initiated by the explosion of a methane-air mixture.

This led to the manufacture of Anzen-Bakuyaku ammonium nitrate safety explosives on the lines of European compositions, but later modified to suit the damp climate of Japan (Yamamoto [85]). The production of the following new explosives began in 1913:

Ume (plum blossom) dynamite derived from British Saxonite; Matsu (pine tree) dynamite, a kind of blasting gelatine; Ran (orchid flower), derived from Carbonite and Kaede (maple leaf), a modification of Belgian Grisoutite. The last two were soon withdrawn from use due to their undesirable products of explosion. The composition of the above explosives is tabulated below (Table 132) (according to Yamamoto [85]).

TABLE 131

HUNGARIAN AMMONIUM NITRATE EXPLOSIVES

Ingredients	Paxit 3	Nitrocertzit
Ammonium nitrate	82 ± 1.5	72 ± 1.5
Di- and trinitrotoluene (1 : 9)	5.4 ± 0.5	4.9 ± 0.5
Nitroglycerine	5 ± 0.5	4 ± 0.5
Collodion cotton	0.1 ± 0.002	1.0 ± 0.002
Woodmeal	3 ± 0.2	0.5 ± 0.1
Charcoal	1.7 ± 0.2	—
Wheat meal	2.5 ± 0.2	1.5 ± 0.2
Sodium chloride	—	17 ± 1
Aluminium hydroxide	0.1 ± 0.02	0.1 ± 0.02
Lubricating oil	0.3 ± 0.02	0.7 ± 0.01
Ferric oxide	0.1 ± 0.002	1.0 ± 0.002
Density	1.04	1.08
Oxygen balance (%)	+4.55	+7.02
Lead block expansion (cm ³)	385 ± 20	235 ± 20
Transmission of detonation (cm)	7	3
Rate of detonation (m/sec)	3950 ± 200	3600 ± 200
Heat of detonation (kcal/kg)	955	603

TABLE 132

JAPANESE MINING EXPLOSIVES

Ingredients	Explosives				
	Anzen Bakuyaku No. 1	Anzen Bakuyaku No. 2	Ume dynamite	Ran dynamite	Kaede dynamite
Nitroglycerine	—	—	58	30	44
Nitrocellulose	—	—	4	—	—
DNT	70	12	—	—	—
Ammonium nitrate	70	88	—	—	—
Potassium nitrate	—	—	17	30	—
Sodium nitrate	28	—	—	—	—
Barium nitrate	—	—	—	—	—
Woodmeal	—	—	7	33	12
Kieselguhr	—	—	—	2	2
Ammonium oxalate	—	—	14	—	—
Sodium sulphate	—	—	—	—	42

Recently rock explosives mainly for use in opencast mining, composed of ammonium nitrate with fuel oil (as invented in the U.S.A. see p. 482) were introduced in Japan.

In 1915 the Regulation for Preventing Coal Mine Explosions was issued. In 1917 an official experimental gallery was erected at Nogata.

After World War I it was found that the mining explosives used till then in Japan did not pass the more stringent tests in the experimental gallery (e.g. those with a 400 g charge). Over the period 1922-24 new, safer explosives appeared which were classed into three groups.

(1) Ume dynamite which was improved by adding a considerable quantity of borax thus making it similar to the British Samsonite.

(2) Shōan dynamite (Shōan is the abbreviation of Shōsan-ammonia, i.e. ammonium nitrate). Shōan dynamite is semi-gelatinous and resembles British Dynobel.

(3) Shōan Bakuyaku, a kind of Ammonite (Table 133).

A new modern experimental gallery (modelled on the one at Buxton in Great Britain) was constructed in 1927 and the explosives which passed the gallery test with the charge of 400 g were designated Permitted Explosives (Kentei Bakuyaku).

During World War II the composition of some explosives was altered due to lack of raw materials such as borax. Ume-dynamite was therefore replaced by Shiraume-dynamite into which ammonium nitrate and sodium chloride were introduced.

After World War II new testing galleries were erected at the factories, facilitating improvements in the manufacture of explosives. The following new types were also introduced. Taketoyo Factory (Japan Oil and Fat Co., Ltd.) introduced new kinds of Toku (special) permitted explosives which contain dried pulverized seaweeds as a cooling agent. Seaweeds contain halogen (Cl, Br, I) and alkali (Na, K) ions (*ca.* 10% by weight) in a finely divided form.

TABLE 133
NEWER JAPANESE MINING EXPLOSIVES

Ingredients	Explosives				
	Ume dynamite A	Shōan dynamite A	Shōan dynamite B	Shōan Bakuyaku A	Shōan Bakuyaku B
Nitroglycerine	49-51	19-21	7-11	4.0-4.5	—
Nitrocellulose	1.5-2.0	0.5-0.7	0.1-0.3	—	—
DNT	—	—	—	6-8	7-9
Ammonium nitrate	—	44-48	62-65	70-72	74-76
Potassium nitrate	8-12	—	—	—	—
Woodmeal	1-3	3-6	4-7	2.5-3.5	1.6-2.5
Starch	—	1.0-2.5	1.5-2.5	—	—
Sodium chloride	—	26-28	19-22	19-21	14-16
Borax	34-36	—	—	—	—
Charge limit (g)	600	800	700	600	500
Ballistic pendulum swing (mm)	54	56	59	56	60

Another improvement consisted of preparing low density explosives (L.D. explosives) which contain ammonium nitrate in the form of bulky, porous crystals

(Vol. II, p. 460). Some of the L.D. explosives can be classified as Eq.S. explosives. S-Shōan dynamite contains powdered talc besides ordinary cooling salts and possesses a high degree of safety.

The following tests for safety in the presence of methane and coal-dust have now been introduced in Japan [86].

Gas test. The charge loaded into the mortar is 400 g. A No. 6 electric detonator is detonated near the mouth of the mortar. The test is repeated ten times without stemming. No ignition should occur.

To investigate new explosives, various charges over 400 g are used. Some of the permitted explosives do not cause any ignition with a charge of up to 800 g. These explosives are classified as:

“no ignition at 500 g”

“no ignition at 600 g” etc.

Coal-dust test. 1500 g coal-dust is uniformly scattered on the four shelves fixed to the walls of the explosion chamber of the gallery, and stirred by the air current produced by a fan. One minute after stopping the fan, the charge is fired. Relative humidity in the explosion chamber is kept below 80%. The test is repeated five times under the same conditions as those in the methane test. No ignition should occur.

Ballistic pendulum test. 100 g charges should give a swing of more than 40 mm to the five tons pendulum.

TABLE 134

JAPANESE PERMITTED GELATINE AND SEMI-GELATINE DYNAMITES

Ingredients	Explosives			
	Shiraume dynamite	Shōan dynamite	Toku Shōan Shin dynamite	L. D. Shōan dynamite
Nitroglycerine (and nitroglycol)	33.0	8.0	8.0	8.0
Nitrocellulose	1.3	0.2	0.3	0.2
Ammonium nitrate	32.8	63.0	69.7	66.6
Woodmeal or starch	2.4	8.0	4.0	8.2
Oil	0.5	—	—	—
Seaweed	—	—	10.0	—
Sodium chloride	30.0	20.8	8.0	17.0
<i>Properties</i>				
Density	1.57	0.95	0.90	0.70
Charge limit (g)	—	—	700	700
Swing of ballistic pendulum (mm)	66	58	—	—
Rate of detonation (m/sec)	6030	3000	—	2200
Lead block expansion (cm ³)	260	250	—	240
Relative power (% of blasting gelatine)	63.1	56.0	—	57.0
Gap test: cartridge diameters (32 mm)	7	6	—	3

More stringent tests, not yet approved officially, are applied to new explosives showing a high margin of safety.

The tests listed above resemble those employed in Europe, and consist of:

- (1) detonating a charge freely suspended in methane-air atmosphere,
- (2) detonating a charge mounted in various ways: plain steel plate, an angle bar, steel rail, an angle-shot mortar, or an angle-shot mortar with a ricochet plate,
- (3) detonating a charge suspended in a kraft-paper tube, with or without a slit,
- (4) firing from a mortar into the gallery by inverse priming, with an expansion chamber.

The composition and properties of the most typical Japanese explosives are summarized in Tables 134 and 135 (according to Yamamoto [85] and Yokogawa [86]).

TABLE 135
JAPANESE PERMITTED AMMONIUM NITRATE EXPLOSIVES

Ingredients	Explosive			
	Ko Shōan Bakuyaku	Toku Shō- an Bakuyaku	L. D. Shō- an Bakuyaku E ₂	Shin D Shōan Bakuyaku
Ammonium nitrate	64.5	72.8	—	76.2
Low density ammonium nitrate	—	—	73.9	—
Nitroglycerine	5.96	4.7	5.0	—
Nitrocellulose	0.04	0.1	0.1	—
DNT	—	1.92	2.0	—
TNT	2.0	—	—	3.0
Nitronaphthalene	—	1.28	—	—
Dinitronaphthalene	—	—	—	6.0
Woodmeal	—	—	7.0	—
Starch	5.5	6.2	2.0	2.8
Seaweed	4.0	—	—	—
Sodium chloride	18.0	5.0	10.0	5.0
Potassium chloride	—	8.0	—	7.0
<i>Properties</i>				
Density	0.96	0.95	0.70	1.00
Swing of ballistic pendulum	69	—	—	65
Rate of detonation (m/sec)	3010	—	—	4000
Relative power (1% of blasting gelatine)	63.8	—	—	67.4
Gap test: cartridge diameters (32 mm)	5	—	—	4

For blasting and quarrying rock blasting blackpowder or ammonal type explosives are used. A typical feature of Japanese explosives is the admission of a few ammonium perchlorate explosives, named Carlits (inventor Carlson). E.g. Midori

(green) carlits are permitted for coal mining while Kuro (black) and Murasaki (purple) carlits are rock explosives unsuitable and suitable, respectively, for underground use. Toku Kaba (special brown) carlit—also a rock explosive—is marked by producing non-toxic fumes and is recommended for underground work where ventilation is inadequate.

The composition of some carlits is tabulated below.

TABLE 136
JAPANESE PERCHLORATE EXPLOSIVES

Ingredients	"Carlit" explosives				
	Kuro	Murasaki	Toku Kaba	Midori	
				III GO	V GO
Ammonium perchlorate	72-77	81-86	46-51	5-9	4-9
Ammonium nitrate	—	—	—	58-63	59-64
Sodium nitrate	—	—	33-31	3-7	2-7
Dinitronaphthalene	—	—	8-13	1-5	1-5
TNT	—	—	—	6-11	6-10
Oil	1-5	1-3	1-3	—	—
Woodmeal	4-9	3-7	2-6	1-5	1-6
Ferrosilicon	14-18	8-12	—	—	—
Sodium chloride	—	—	—	11-16	10-15
<i>Properties</i>					
Density	1.05	1.11	1.15	1.05	1.06
Swing of ballistic pendulum (mm)	82	80	70	68	67
Rate of detonation (m/sec)	4400	4400	4000	3000-4300*	3000-4300*
Lead block expansion (cm ³)	485	465	320	285	285
Relative power (% of blasting gelatine)	90	90	60	50	50
Gap test: cartridge diameters (32 mm)	5	6	4.5	4.5	4.5

* Different figures according to various sources.

Explosives with a safety sheath are also used. The safety sheath must correspond to Japanese Industrial Standard M 7609 (1952). Two kinds are used: (1) a sheath wrapper into which the cartridge is rolled, and (2) a sheath tube made in the form of a pipe into which a cartridge is inserted.

Safety sheaths undergo gas and coal-dust tests in the gallery in which the sheath covers 450 g of a standard explosive composed of:

Ammonium nitrate	83.7%
Nitroglycerine	8%
Collodion cotton	0.3%
Woodmeal	8.0%

The power of sheathed explosive is tested using the sheath to cover a standard explosive composed of:

Ammonium nitrate	64.8%
Nitroglycerine	8.0%
Collodion cotton	0.2%
Woodmeal	7.0%
Sodium chloride	20.0%

The swing of the ballistic pendulum should be 55 mm or more and the gap distance 3.5 times the diameter or more.

POLAND

After World War I German explosives were used to some extent in Poland. Detonating powder, black blasting powder, dynamites, ammonites and chloratits were used as rock explosives. Chloratit 3 with a composition corresponding to that of Miedziankit of Łaszczyński (p. 278) ranked high among rock explosives. Explosives safe in the presence of methane and coal-dust, such as ammonium nitrate, Lignozyts, Bradyts, semi-gelatinous and gelatinous Bradyts were also employed.

Polish safety explosives for coal mining included Bradyt F. Its composition was developed by T. Urbański [87]:

77.5% of ammonium nitrate	4% of nitroglycerine
4% of potassium perchlorate	9% of sodium chloride
4% of TNT	1.5% of woodmeal

A feature of Bradyt F was the introduction of potassium perchlorate which increased the safety of the explosive by virtue of the potassium chloride formed on explosive decomposition. This proved effective in the experimental gallery. However, after being in use for many years, explosives of this type were withdrawn because of their comparatively high power (lead block expansion *ca.* 280 cm³) which was considered much too high for coal working, when more stringent regulations were introduced.

There are now four groups of mining explosives in use:

A. Rock explosives, which are divided into 3 subgroups according to their chemical composition:

- (1) Ammonium nitrate explosives (ammonites);
- (2) Nitroglycerine explosives (dynamites);
- (3) Blackpowder.

They may be used only for rock, where there is no coal and no risk of gas. They may also be used, exceptionally, in mines where gas can be present, provided that the content of methane is less than 0.1% at faces situated 50 m away in slightly dusty areas, and 150 m away in very dusty ones.

B. Coal explosives. They may be used only in non gassy coal seams. Their use is limited to strictly determined areas where dangerous coal-dust occurs. They may also be used instead of explosives of group A.

TABLE 137

A. POLISH ROCK EXPLOSIVES (AMONITS)

Ingredients	Explosives				
	Amonit skalny 0	Amonit skalny 2	Amonit skalny 5	Amonit skalny 6	Amonit skalny 8
Ammonium nitrate	90	84.5	83.5	80.9	81
Nitroglycerine	—	—	—	4	4
DNT	—	2	2	—	2
TNT	10	11.8	7.5	8	5.5
Woodmeal	—	1.5	—	2	—
Ferric oxide	—	0.2	—	0.1	—
Aluminium	—	—	7	5	7.5
Lead block expansion (cm ³)	—	330	—	400	400
Rate of detonation (m/sec)	—	3300-3700	—	—	—
Transmission of detonation (cm)	—	4	—	8	8

TABLE 138

A. POLISH ROCK EXPLOSIVES (DYNAMITS)

Ingredients	Explosives						
	Dynamit skalny 1	Dynamit skalny 1G	Dynamit skalny 2GI	Dynamit skalny 3GH waterproof	Dynamit skalny 5A	Dynamit skalny 5G1	Dynamit skalny 5G2
Nitroglycerine	63	45.75	17.1	55	22	17.2	11
Nitroglycol	—	15.25	4.9	15.4	—	4.8	11
Nitrocellulose	2	3	1	4.5	0.8	0.8	1.3
DNT	—	—	2	—	4	4	4
TNT	—	—	5	—	7	7	7
Ammonium nitrate	—	—	68.5	—	50	50	49
Sodium nitrate	27	28	—	—	14.8	14.8	15.6
Potassium nitrate	—	—	—	19.3	—	—	—
Woodmeal	8	8	1	5.7	1	1	1
Ferric oxide	—	0	0.1	0.1	0.1	0.1	0.1
Glycerine	—	—	0.4	—	—	—	—
Glycol	—	—	—	—	0.3	0.3	—
Density	—	1.45	1.45	1.37	1.45	1.45	1.45
Lead block expansion (cm ³)	—	390	330	440	320-350	320-350	320-350
Rate of detonation (m/sec)	—	5000	6100	6100	2400	2500	2500
Transmission of detonation (cm)	—	12	7	8	8	10	10

C. Permitted explosives, which are divided into 2 subgroups according to their chemical composition:

- (1) Ammonium nitrate explosives;
- (2) Nitroglycerine explosives (permitted dynamites).

Both may be used in coal mining where the content of methane in the air is less than 1%. In more dangerous areas only ammonium nitrate explosives are permitted. Both may also be used wherever A and B explosives are permitted.

D. Permitted special explosives. They may be used in coal mines where the content of methane in the air is less than 1.5% and in mines where particularly sensitive coal-dust occurs.

The explosives used in Poland should not be prone to deflagration (this is discussed on p. 417).

Those permitted for use in gassy and dusty mines should meet the requirements outlined on p. 439.

TABLE 139

B. POLISH COAL EXPLOSIVES (KARBONITS)

Ingredients	Explosives				
	Karbonit węglowy D2	Karbonit węglowy D29	Karbonit węglowy D3	Karbonit węglowy D4	Karbonit węglowy D49
Ammonium nitrate	72	72	68.5	75	75
Nitroglycerine	4	2	4	4	3
Nitroglycol	—	2	—	—	1
DNT	2	2	2.5	1.5	1.5
TNT	4	4	6.5	5.5	5.5
Woodmeal	3	3	3.5	3.5	3.5
Sodium chloride	15	15	15	10.5	10.5
Density	1.03	—	—	—	—
Lead block expansion (cm ³)	255	—	270–285	270	—
Rate of detonation (m/sec)	2600	—	1900–2200	—	—
Transmission of detonation (cm)	5	—	4–5	4–5	—

Since these explosives may be used safely only in mines where little or no gas occurs, Cybulski has recently formulated explosives which may be used in mines where much gas is present and where ordinary permitted explosives are not generally approved. Two such explosives are used: permitted special Metanit A and permitted special Metanit B. They are ammonium nitrate explosives with a very high content of cooling salt (e.g. up to 50% sodium chloride). Permitted special Metanits are very safe in the presence of firedamp and coal-dust. They stand up to the tests described above and do not ignite firedamp even with a 1.5–2 kg charge suspended

TABLE 140
C. POLISH PERMITTED EXPLOSIVES (AMMONIUM NITRATE-TYPE METANITS)

Ingredients	Explosives									
	Metanit powietrzny D2	Metanit powietrzny D29	Metanit powietrzny D2G1	Metanit powietrzny D3	Metanit powietrzny D39	Metanit powietrzny W1	Metanit powietrzny WIG			
Ammonium nitrate	63	63	63	67.5	67.5	55	55			
Nitroglycerine	4	2	3.64	4	3.12	5	4.55			
Nitroglycol	—	2	0.36	—	0.88	—	0.45			
DNT	1	1	1	1	1	1	1			
TNT	3.5	3.5	3.5	4	4	3.5	3.5			
Woodmeal	3.5	3.5	3.5	3.5	3.5	3.5	3.5			
Sodium chloride	28	25	25	20	20	27	27			
Ammonium chloride	—	—	—	—	—	5	5			
Density	1.0	—	—	—	—	1.0	—			
Lead block expansion (cm ³)	190-230 (average 210)	—	—	—	—	18-230 (average 205)	—			
Rate of detonation (m/sec)	1700	—	—	—	—	1800	—			
Transmission of detonation (cm)	3-5	—	—	—	—	3-5	—			
Charge limit (g)	500	—	—	—	—	500	—			

TABLE 141

C. POLISH PERMITTED EXPLOSIVES (DYNAMITE-TYPE BARBARYTS)

Ingredients	Explosives		
	Barbaryt powietrzny A1	Barbaryt powietrzny AG1	Barbaryt powietrzny AG2
Nitroglycerine	23	17.2	14
Nitroglycol	—	4.8	8
Nitrocellulose	0.5	0.5	0.8
DNT	3	2.5	—
TNT	—	—	2
Ammonium nitrate	32.5	30.5	21
Sodium nitrate	4	4	6
Sodium chloride	35.5	38	45
Talc	1	1.5	1
Glycerine	—	1	1
Glycol	0.5	—	—
Saturated aqueous solution of ammonium nitrate	—	—	1.2
Density	1.45	1.45	1.45
Lead block expansion (cm ³)	190	190	160
Rate of detonation (m/sec)	2300	2200	2200
Transmission of detonation (cm)	4-10	4-10	3-8

These ingredients are used to "soften" the mixtures and to facilitate mixing and cartridging

TABLE 142

D. POLISH PERMITTED SPECIAL EXPLOSIVES (SPECIAL METANITS)

Ingredients	Explosives	
	Metanit powietrzny specjalny B	Metanit powietrzny specjalny C
Ammonium nitrate	42.5	47.5
Nitroglycerine	6	6
TNT	3.5	3.5
Woodmeal	3	3
Sodium chloride	45	40
Density	1.0	
Lead block expansion (cm ³)	130-170 (average 140)	
Rate of detonation (m/sec)	1600	
Transmission of detonation (cm)	4-6	
Charge limit (g)	1000	

in an explosive mixture of firedamp. Permitted special Metanits correspond to the British Eq. S. explosives.

In Poland, as in all parts of the world, blasting gelatine consisting of 92–94% nitroglycerine and 8–6% dynamite collodion cotton is used for work in hard rock.

U.S.A.

The rock explosives used in the U.S.A. are similar in composition to those used in Europe. In addition to blackpowder (with Chilian saltpetre) dynamites with the composition tabulated below are used extensively. The oldest are the "straight dynamites" designated by percentage expressing the content of nitroglycerine. The latter is not gelatinized but only adsorbed by woodmeal and the like.

TABLE 143
U.S.A. STRAIGHT DYNAMITES
(% EXPRESSES THE RELATIVE POWER OF THE EXPLOSIVE)

	20%	30%	40%	50%	60%
Nitroglycerine	20.2	29.0	39.0	49.0	56.8
Sodium nitrate	59.3	53.3	45.5	34.4	22.6
Sulphur	2.9	2.0	—	—	—
Carbonaceous combustible material (e.g. woodmeal, starch)	15.4	13.7	13.8	14.6	18.2
Antacids (calcium carbonate, zinc oxide etc.)	1.3	1.0	0.8	1.1	1.2
Moisture	0.9	1.0	0.9	0.9	1.2

A mixture with nitroglycol is now generally used instead of pure nitroglycerine. Gelatine dynamites are similar in composition. They contain nitroglycerine (and nitroglycol) and are gelatinized with nitrocellulose.

TABLE 144
U.S.A. GELATINE DYNAMITES (% EXPRESSES THE RELATIVE POWER OF THE EXPLOSIVE)

	20%	30%	40%	50%	60%	80%	100%*
Nitroglycerine (+ nitroglycol)	20.2	25.4	32.0	40.1	49.6	65.4	91.0
Nitrocellulose	0.4	0.5	0.7	0.8	1.2	2.6	7.9
Sodium nitrate	60.3	56.4	51.8	45.6	38.9	19.5	—
Sulphur	8.2	6.1	2.2	1.3	—	—	—
Carbonaceous combustible material	8.5	9.4	11.2	10.0	8.3	10.1	—
Antacids	1.5	1.2	1.2	1.2	1.1	1.7	0.8
Moisture	0.9	1.0	0.9	1.0	0.9	0.7	0.1

* 100% gelatine dynamite is usually called "blasting gelatine".

Since the high price of nitroglycerine makes the use of straight or gelatine dynamites rather costly in relation to their power, it may be partly substituted by

ammonium nitrate, giving "ammonium dynamites" and "ammonium gelatines" (Tables 145 and 146. The percentage expresses the relative power of the explosive.)

TABLE 145
U.S.A. AMMONIUM DYNAMITES

	20%	30%	40%	50%	60%
Nitroglycerine	12.0	12.6	16.5	16.7	22.5
Ammonium nitrate	11.8	25.1	31.4	43.1	50.3
Sodium nitrate	57.3	46.2	37.5	25.1	15.2
Sulphur	6.7	5.4	3.6	3.4	1.6
Carbonaceous combustibles	10.2	8.8	9.2	10.0	8.6
Antacids	1.2	1.1	1.1	0.8	1.1
Moisture	0.8	0.8	0.7	0.9	0.7

TABLE 146
U.S.A. AMMONIUM GELATINES

	30%	40%	50%	60%	80%
Nitroglycerine	22.9	26.2	29.9	35.5	38.3
Nitrocellulose	0.3	0.4	0.4	0.7	0.9
Ammonium nitrate	4.2	8.0	13.0	20.1	34.7
Sodium nitrate	54.9	49.6	43.0	33.5	19.1
Sulphur	7.2	5.6	3.4	—	—
Carbonaceous combustibles	8.3	8.0	8.0	7.9	4.3
Antacids	0.7	0.8	0.7	0.8	0.9
Moisture	1.5	1.4	1.6	1.7	1.8

It is characteristic of many of these explosives that most of them contain sulphur, unlike European explosives.

As in Europe, ammonium nitrate explosives consist of mixtures of ammonium nitrate with various ingredients:

- (1) explosive, such as nitroglycerine or nitrostarch,
- (2) combustible, but non-explosive.

In the first group there are mixtures with the following composition:

Ammonium nitrate 40–80%
Nitroglycerine or nitrostarch 3–10%
(less frequently aromatic nitro compounds are employed)

made up with woodmeal and antacid ingredients.

The second group is represented by a mixture of:

Ammonium nitrate 92.5%
DNT 4.0%
Paraffin wax 3.5%

Its rate of detonation varies with the diameter of the cartridge from 3500 to 5000 m/sec. The gap test gives a value of 12–45 cm.

In the U.S.A. in 1956 a new class of rock explosives was tried for the use in opencast mines, based on a patent taken out by Lee and Akre [88]. They are low cost explosives composed of ammonium nitrate and an inexpensive fuel such as carbon black. Rapid development took place in 1957–58 and their use was extended to certain underground operations. Fuel oil was next used as a combustible ingredient (AN–FO) explosives.

AN–FO explosives are usually made in the mine (“do-it-yourself” explosives) thus saving the cost of explosives transport.

Usually prilled ammonium nitrate is used as it facilitates detonation of the explosive and the porosity of the granules help to retain the liquid ingredient.

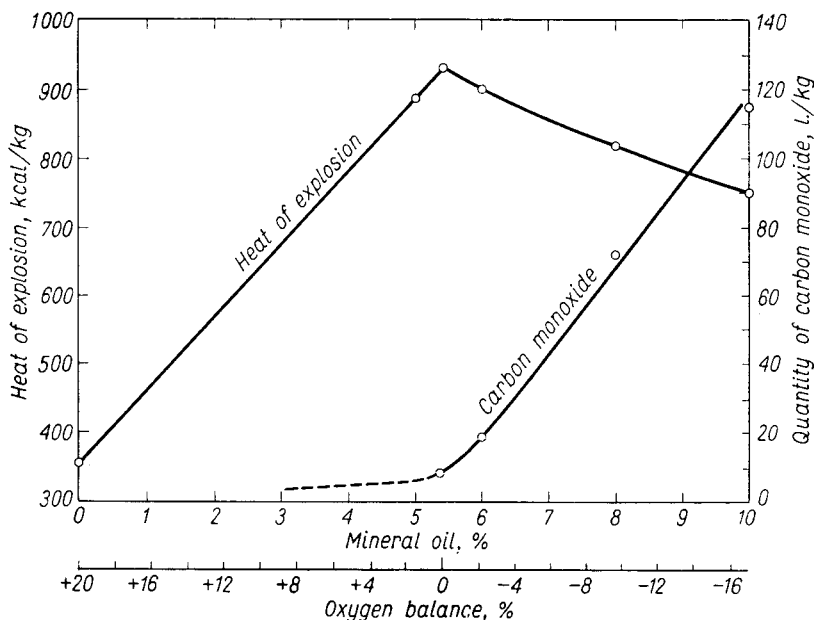

FIG. 156. Explosive properties of ammonium nitrate–mineral oil mixtures as a function of mineral oil content [71].

The ratio of ammonium nitrate to fuel oil giving a zero oxygen balance is *ca.* 95/5. The highest rate of detonation (*ca.* 3300 m/sec using a 100 mm dia. cartridge in a steel tube) is reached when the fuel oil content is 5–6% [89]. The rate of detonation can be raised to 6000 m/sec by detonating a PETN fuse all along the cartridge. Very often initiation is strengthened by adding a cartridge of a readily detonating explosive, e.g. 60% dynamite. The most easily initiated mixture contains 2% of fuel oil. With 10% of fuel oil the ease of detonation is considerably impaired.

Wetterholm [71] gives a summary of explosive properties of ammonium nitrate–mineral oil mixtures as a function of the oil content (Fig. 156). Another diagram

by the same author (Fig. 157) gives a minimum charge diameter for stable detonation of ammonium nitrate–Diesel oil mixtures with 5% water or without water, against the composition of the mixtures (Diesel oil content).

It is advisable to use ammonium nitrate with as little as possible of the inert material usually added to ammonium nitrate to prevent its caking. According to the same source, the quantity of inert material should not exceed 0.4% of NH_4NO_3 (fertilizer grade ammonium nitrate usually contains 2–5% added matter).

The diameter of the cartridges used for opencast mining is usually 100 mm, which evidently facilitates detonation.

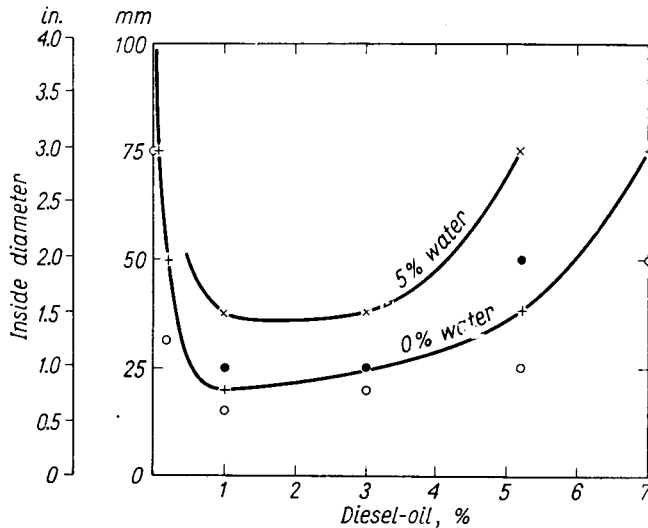

FIG. 157. Minimum charge diameter for stable detonation in iron tubes (wall thickness 3 mm). Initiation by No. 8 detonator and 27 g compressed TNT; 5% water: †—detonation, ●—miss; 0% water: +—detonation, ○—miss [71].

As mentioned before, preparation of AN–FO explosives is usually carried out where they are to be used. The methods are described later in the chapter on the manufacture of mining explosives.

AN–FO explosives are approximately twice as cheap as the usual ammonium nitrate rock explosives and three times cheaper than dynamites.

They have become very popular not only in the U.S.A. but also in Canada, U.S.S.R., Japan and Sweden.

More information is to be found in papers presented at an International Symposium in Rolla, Missouri [90].

A modified type of AN–FO explosive has been suggested in the U.S.A., made by mixing ammonium nitrate with nitromethane (*ca.* 5%) which is itself explosive. They have a higher rate of detonation than AN–FO (e.g. 3900 m/sec). However, they have not been widely used because of their higher price.

The other types of cheap ammonium nitrate explosives to be made on the spot by mixing ammonium nitrate with cheap solid fuel such as carbon black, peat, brown coal etc. were also suggested in the U.S.A. They are much less popular than AN-FO.

Safety explosives

Safety explosives are known in the U.S.A. under the name of Permissible Explosives or simply permissibles. As in European countries their chief ingredient is ammonium nitrate. Permissibles may or may not contain nitroglycerine.

According to Taylor and Rinkenbach [91] permissible Monobel contains:

Ammonium nitrate	80%
Nitroglycerine	10%
Combustible and other material	10%

No detailed information is available about the compositions of permissibles, which are kept secret by the producers.

An ammonium nitrate explosive in widespread use is Nitramon (Kirst, Woodbury and McCoy [92]) containing ammonium nitrate with DNT. It is not classified as "permissible".

U.S.S.R.

Mining explosives are classified in the U.S.S.R. into the following groups:

- (I) Approved for opencast works;
- (II) Approved for opencast and underground works in non-gassy and non-dusty mines;
- (III) Approved for rock work in gassy and dusty mines;
- (IV) Approved for rock and coal work in gassy and dusty mines;
- (V) Approved for sulphur mines.

Groups (I) and (II) comprise non-permitted explosives, groups (III)–(V)—permitted explosives.

The permitted explosives are tested in experimental galleries in the presence of methane and coal-dust (explosives of groups (III) and (IV)), or in the presence of sulphur dust (explosives of group (V)). The explosives intended for use in oil fields are tested for safety towards petroleum vapours.

The non-permitted explosives and those permitted for works in sulphur and oil fields have cartridges 31–32 mm dia.

The explosives of group (IV) have cartridges 36–37 mm dia. The compressed Ammonits have a cartridge diameter not less than 36 mm.

The composition and properties of some of these explosives are given in Tables 147–153.

Explosives for underground work are not usually allowed to contain more than 0.5% moisture. The requirements for explosives for opencast work are not so stringent and a moisture content of up to 1.5% is approved.

TABLE 147
U.S.S.R. NON-PERMITTED EXPLOSIVES
ROCK EXPLOSIVES FOR OPENCAST WORK (GROUP I)

Ingredients	Explosives	
	Ammonit No. 9	Ammonit No. 10
Ammonium nitrate	87	85
TNT	5	8
Woodmeal or powdered peat, or powdered cottonseed cake or asphaltite	8	7
Density	0.8-0.9	0.85-0.95
Lead block expansion (cm ³)	300-330	300-330
Transmission of detonation (32 mm dia.) cm	2-3	2-4
Rate of detonation (m/sec)	3000-3500	3200-3600
Heat of detonation (kcal/kg)	857	905

TNT in various forms (flakes, pressed or cast charges) is also approved for opencast mining.

TABLE 148
U.S.S.R. ROCK EXPLOSIVES FOR OPENCAST WORK

Ingredients	Explosives				
	Ammonit No. 6			Ammonit No. 7	Dinaftalit No. 1
Ammonium nitrate		79		81	88
TNT		21		14	-
DNT		-		-	12
Powdered bark		-		5	-
	Form				
	Powder	Corned	Pressed		
Density	1.0-1.1	1.0-1.15	1.25-1.35	1.0-1.1	1.0-1.1
Lead block expansion (cm ³)		360-380		350-370	320-360
Transmission of detonation when dry (cm)	5-10	4-8	5-10	4-6	3-6
when moist (cm)	3-5			2-3	2-5
Rate of detonation (m/sec)	3600-4200	3600-3800	4600-5500	3600-3900	3500-4500
Heat of detonation (kcal/kg)	1028	1028	1028	962	950-976

Dinitronaftalit No. 1 Zh V and No. 1 V and Ammonits No. 6 Zh V and No. 7 Zh V comprising ammonium nitrate partly waterproofed are also used. All these explosives are required to transmit detonation after storage under water at a depth of 1 m for 1 hr. The transmission figures when moist are given above.

Rock Ammonits No. 1, No. 1 Zh V (water-proof) and No. 2 are also used.

They are more powerful than the Ammonits described above and are manufactured in the form of compressed cartridges 36 and 45 mm dia. (250 and 400 g of weight, respectively) or powdered material 60–210 mm dia. The compressed cartridges are supplied together with the initiators fitted with detonator pockets.

The properties of rock Ammonits are given in Table 149.

TABLE 149
U.S.S.R. ROCK AMMONITS

Properties	Ammonits				
	Rock No. 1		Rock No. 1 ZhV		Rock No. 2
	Powder	Pressed	Powder	Pressed	Pressed
Density	0.95–1.1	1.45–1.5	0.95–1.1	1.45–1.51	1.5–1.6
Moisture (max)	0.2		0.2		0.2
Oxygen balance (%)	–2.2		–0.7		+0.13
Lead block expansion (cm ³)	450–480		450–480		420–440
Transmission of detonation when dry (cm)	6–10	4–8	7–12	5–9	7–10
after being kept in water (1 m depth) for 1 hr (cm)	4–6	3–8	5–8	5–9	7–10
Rate of detonation (m/sec)	4000–5000	6000–6500	4000–5000	6000–6500	6500–7000
Heat of detonation (kcal/kg)	1270	1270	1290	1290	1166

Another group of very powerful non-permitted explosives are the Ammonals: VA-2, VA-4, VA-8. All are water-proof. They are characterized by the presence of aluminium powder. Their properties are similar to those of rock Ammonits.

The non-permitted explosives include low-freezing 62% dynamite composed of:

Nitroglycerine	37%
Nitrodiglycol (DGDN)	25%
Nitrocellulose	3.5%
Sodium or potassium nitrate	32%
Woodmeal	2.5%

It is manufactured in cartridges with diameters of 31–32 mm (200–250 g) and 44–45 mm (500–550 g).

Its properties are:

Density	1.40–1.45
Lead block expansion	380–420 cm ³
Transmission of detonation when dry 8–10 cm and after being kept in water	(the same)
Rate of detonation	6000–7000 m/sec
Heat of detonation	1200 kcal/kg

Low density Ammonit No. 14 is a relatively new explosive — it was first tested in 1954. It contains low density ammonium nitrate and 7% nitroglycerine. Its properties are:

Density	0.75–0.80
Oxygen balance	–0.2%
Lead block expansion	320–350 cm ³
Transmission of detonation	4–8 cm
Rate of detonation	1800–2500 m/sec
Heat of detonation	900 kcal/kg

Cheap ammonium nitrate–fuel oil explosives (p. 482) are also in use in the U.S.S.R. under the name of Igdanit.

TABLE 150
U.S.S.R. PERMITTED EXPLOSIVES
PERMITTED AMMONITS

Ingredients	Explosives		
	Ammonit No. 8	Ammonit AP-1	Ammonit AP-2
Ammonium nitrate	68	65	68.5
TNT	10	14	15
Woodmeal	–	–	1.5
Powdered bark	2	1.5	–
Sodium chloride	20	19.5	–
Potassium chloride	–	–	15
Density	1.00–1.15	1.00–1.15	1.00–1.15
Lead block expansion (cm ³)	240–280	260–290	285–310
Transmission of detonation (cm)	3–5	4–7	4–8
Rate of detonation (m/sec)	2500–3000	3000–3500	3200–3700
Heat of detonation (kcal/kg)	690	800	855

A water-proof modification of a permitted Ammonit is water-proof Ammonit PZh V-20. It is more easily detonated than Ammonit No. 8. The other water-proof Ammonits are: AP-4 ZhV and AP-5 ZhV. They are used in damp conditions.

The permitted explosives Pobedit (Pobeda = Victory) are widely used: rock and coal Pobedit PU-2; water-proof Pobedit VP-1; Pobedit No. 6; water-proof Pobedit VP-2.

All are of low nitroglycerine content (5–9%).

Their properties are given in Table 151.

Pobedit P-8 is an ammonium nitrate sheathed explosive with 7% nitroglycerine. The sheath is composed of potassium chloride powder.

The properties of this explosive are:

Density	1.0–1.15
Lead block expansion	285–310 cm ³
Rate of detonation	3500–4000 m/sec

TABLE 151

POBEDITS

Properties	Pobedit PU-2	Pobedit VP-1	Pobedit No. 6	Pobedit VP-2
Density	1.00-1.10	1.15-1.30	1.00-1.10	1.15-1.30
Oxygen balance (%)	-0.53	+0.51	-0.14	+0.3
Lead block expansion (cm ³)	250-280	265-290	285-310	320-340
Transmission of detonation when dry (cm)	5-10	6-20	5-15	6-20
after storage in water (cm)	-	5-15	-	5-14
Rate of detonation (m/sec)	2800-3500	3200-3700	3500-4000	3800-4300
Heat of detonation (kcal/kg)	800	813	870	910

The explosive part of the cartridge has 28 ± 0.5 mm dia., and a weight of 132 ± 7 g. With the sheath its diameter is 36 ± 1 mm and weight 225 ± 15 g.

The transmission of the detonation figure for the complete cartridge is 4-7 cm.

Pobedit P-8 is tested not only in a steel mortar in a gallery, but also suspended free in methane atmosphere and in the presence of coal-dust.

Ammonit No. 15 is a low density permitted explosive, containing 8% nitroglycerine. Its properties are:

Density	0.7-0.8
Oxygen balance	-0.03%
Lead block expansion	240-260 cm ³
Transmission of detonation	3-6 cm
Rate of detonation	1700-2300 m/sec
Heat of detonation	800 kcal/kg

It is supplied in two dimensions:

31-32 mm dia., weight 150 g
and 36-37 mm dia., weight 200 g

TABLE 152

U.S.S.R. SULPHUR AMMONITS

Properties	Sulphur Ammonit No. 1	Sulphur Ammonit No. 2
Density	0.95-1.05	0.95-1.05
Oxygen balance (%)	-0.8	-0.5
Lead block expansion (cm ³)	200-220	150-170
Transmission of detonation (cm)	5-8	4-7
Rate of detonation (m/sec)	2500-3000	2000-2500
Heat of detonation (kcal/kg)	720	600

Permitted explosives for various purposes

In sulphur mines. Sulphur Ammonits No. 1 and No. 2 are used. They contain 5% nitroglycerine. They are recommended when the sulphur content of an ore is lower and higher than 20%, respectively.

Their properties are given in Table 152.

In oil fields. Petroleum Ammonits are ammonium nitrate explosives with a low (4-9%) nitroglycerine content. Their properties are given in Table 153.

TABLE 153
U.S.S.R. PETROLEUM AMMONITS

Properties	Neftyanoy Ammonit No. 1	Neftyanoy Ammonit No. 2	Water-proof neftyanoy Ammonit No. 3
Density	0.95-1.05	0.95-1.05	1.1-1.3
Oxygen balance (%)	-0.2	+0.1	-0.3
Lead block expansion (cm ³)	220-230	230-250	220-240
Transmission of detonation when dry (cm)	5-8	5-10	3-7
after storage in water at a depth of 40 cm for 1 hr (cm)	-	-	2-5
Rate of detonation (m/sec)	2000-2500	2500-3200	2500-3200
Heat of detonation (kcal/kg)	634	690	700

Petroleum ammonits No. 1 and No. 2 are recommended where there is a danger of petroleum vapours or of petroleum plus methane.

COMBINED BLASTING AND WATER INFUSION FOR COAL BREAKING

As a further stage in the effort to reduce the risk involved in the use of explosives in mines, an old idea was recently reintroduced. It was decided that safety in use may be increased by surrounding the charge with a layer of water (e.g. in a paper container, circular in cross-section). As long ago as 1876 this method suggested by MacNab [24] was recognized as effective for diminishing the danger of gas ignitions.

Water infusion applied at high pressure in holes drilled in the coal face was used to mine coal in some Westphalian collieries in 1914, and in some mines in South Wales in 1942.

Besides being safe in themselves, these methods considerably reduce coal-dust concentrations.

Demellenne [93] experimented in Belgium with small charges of explosives, using the gas pressure that developed as the motive force to obtain the desired infusion. A considerable reduction of coal-dust (by *ca.* 40%) was claimed.

The new technique of pulsed infusion shot-firing was then introduced in Great Britain. It required the development of highly water-proof explosives. Polar Ajax was originally suggested, but it was only capable of withstanding a water pressure of *ca.* 20 lb/in² for a few hours, whereas ability to withstand up to 800 lb/in² water pressure was required. Earlier work had shown that barium sulphate increases the sensitiveness of nitroglycerine gelatine explosives under high water pressure. This property had been applied in geophysical investigation and existing explosives for deep seismic prospecting therefore provided a basis for the new development.

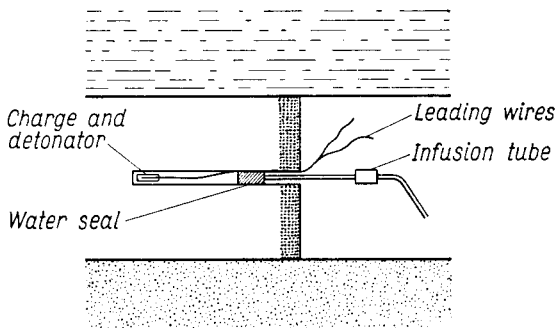

FIG. 158. Blasting coal, employing combined blasting-water infusion technique, according to J. Taylor and Gay [4].

Eventually a new explosive Hydrobel was developed by Haslam, Davidson and Hancock [94] (Table 154). Submarine-type electrical detonators for short holes (Fig. 158) and Cordtex detonating fuse for long (up to 150 ft) holes are used to

TABLE 154

HYDROBEL

Nitroglycerine and nitroglycol	40.9-37.9
Nitrocellulose	3.0-1.0
Ammonium nitrate	21.0-19.0
Sodium chloride	28.1-26.1
Barytes	10.7-8.7
Chalk	1.0-0.1
Diammonium phosphate	0.8-0.1
Woodmeal	1.6-0.6
Acid Magenta	0.05-0.001
A. S. No. 2 (optional)	0.01-0.001
Volatile matter	2.0-0.0
Density	1.7
Power (in % of blasting gelatine)	48
Rate of detonation of unconfined explosive in 1¼ in. diameter cartridges (m/sec)	6000

detonate the charge. A Cordtex detonating fuse consists of a high-explosive core surrounded by textile layers made water-proof by an outer plastic. To increase safety, the fuse is coated with a balata composition, in which one sixth of the weight consists of finely ground cryolite.

The new technique of mining coal is based on the introduction of water at a pressure ranging from 100 to 400 lb per sq. in. The water is forced by the infusion pump into the shothole which is loaded with Hydrobel explosive and sealed with stemming.

This technique of coal-getting by combined blasting and water infusion eliminates the need for undercutting. It is known that undercutting is largely responsible for the formation of coal-dust. The hazard is considerably reduced by wetting the coal-dust before it is suspended in the air. In addition the toxicity of the fumes is reduced as some of the toxic constituents, such as N_2O_4 , are soluble in water.

LIQUID OXYGEN EXPLOSIVES (OXYLIQUITS)

Oxyliquits are explosives consisting of combustible materials impregnated with liquid oxygen. They were invented by Linde [95] and were originally prepared by impregnating such substances as sawdust, carbon black etc. with liquid air. These mixtures, however, were hard to detonate since, as appeared later, they were incapable of adsorbing a sufficient amount of the liquid and so did not contain enough oxygen. Substances with highly adsorptive properties then began to be added, for instance activated coal, or incombustible adsorbents such as kieselguhr.

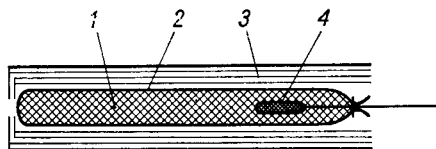

FIG. 159. Section of the oxyliquit charge.

The disadvantage of employing liquid air is that it usually contains less than 33% oxygen which is not always enough for complete combustion. Moreover the composition of liquid air undergoes continuous alteration on storage. Liquid air has therefore been superseded by 98% liquid oxygen.

A charge of oxyliquit is shown in longitudinal section in Fig. 159. Adsorbent combustible mixture (1) is enclosed in a cotton or paper bag (2) 30–50 mm dia. (the use of smaller diameters is not recommended since the charge loses rapidly oxygen by evaporation). The bag with the combustible mixture is placed within a double-walled envelope (3) made of corrugated and ordinary cardboard which stiffens the cartridge and constitutes a thermal insulator. The outer diameter of the cartridge plus envelope is 35–60 mm, its length—300 mm. In ignition cartridges the inner

bag includes a detonator with electric fuse (4). Safety fuses cannot be fired in coal mines for fear of premature explosion which may result from the sparking the safety fuse or ignition of the molten pitch insulating the braid of the safety fuse.

Before firing the prepared cartridges are dipped in a Dewar vessel containing liquid oxygen. The cartridge absorbs the oxygen and gradually sink in it, after which the explosive charge is ready for use (impregnation lasts for about 20 min). The prepared cartridges are placed into the shothole (one of them should have a detonator with an electric fuse) and further procedure is then routine. The shot must not be fired later than 10–15 min (depending on the composition of the cartridge) after the cartridges have been taken out of oxygen.

The efficiency of oxyliquits depends on:

- (1) the composition of the absorbent (combustible);
- (2) the quantity of oxygen adsorbed;
- (3) the time from the moment of impregnation with oxygen to the moment of shotfiring;
- (4) the losses due to the evaporation of oxygen.

The composition of the combustible mass. The power of oxyliquits depends on the composition of the absorbent. D oxyliquits are very strong explosives with a performance resembling that of dynamite; A oxyliquits have a performance equal to that of ammonium nitrate explosives; P oxyliquits have a relatively slow action similar to blackpowder.

Kast and Haid [96] report figures characteristic of the absorbent on the explosive properties of some oxyliquits (Table 155).

TABLE 155
D OXYLIQUITS

Properties	Absorbent				
	Karben*	Carbon black	Cork dust	Woodmeal	Peat
Density of prepared explosive	1.04	0.72	0.63	0.82	0.53
Heat of explosion (kcal/kg)	2180	1995	1660	1535	1670
Gas volume (V_0 , l./kg)	615	535	700	700	700
Calculated temperature of explosion (°C)	5750	6500	4195	4095	4385
Lead block expansion (cm ³)	535	530	510	450	485
Rate of detonation in the open, m/sec)	4760	4680	3300	3610	3275

* Alias "Kupren" – absorbent obtained by the polymerization of acetylene on a copper catalyst at temperatures 200–280°C.

The explosives enumerated in Table 155 are very powerful type D oxyliquits. Their power may be reduced by the addition of inert cooling substances, e.g. sodium chloride, kieselguhr etc. An explosive is then obtained with a performance similar to

that of coal explosives, e.g.:

Petrol	12%
Carbon black	63%
Kieselguhr	25%

This oxyliquit has a rate of detonation of 3430 m/sec.

If the power of oxyliquits is to be increased to obtain rock explosives, this may be achieved by the addition of aluminium.

A disadvantage of mixtures of liquid oxygen with combustible substances lies in their high sensitiveness to impact and friction. This property depends largely on the composition of the combustible material used. Oxyliquits containing sawdust show the lowest sensitiveness, while those containing hydrocarbons (e.g. naphthalene) pitch or petrol are more sensitive.

Explosives with liquid oxygen were used in Poland in some Upper Silesian mines during the inter-war period. To increase their safety, cartridges of Badowski's invention composed of 35% woodmeal and 65% sodium chloride were used. A cylindrical piece of ice was also introduced into the bottom of the shothole. A similar extinguisher was inserted at the mouth of the shothole. This did in fact give greater safety against coal-dust.

The amount of oxygen absorbed. The effect of the oxygen content absorbed by the combustible mass in the liquid phase on the explosive power is represented in Table 156.

TABLE 156

Oxygen content in liquid phase %	Lead block expansion cm ³
35	no explosion
40	9
50	30
55	147
98	384

The amount of oxygen adsorbed by various combustible substances and, for the sake of comparison, that required for the combustion of the substance is shown in Table 157.

TABLE 157

Combustible substance	Amount of oxygen adsorbed by 1 g of the substance, g	Amount of oxygen required for com- bustion of 1 g to CO ₂ +H ₂ O, g
Sawdust	2.4	1.37
Cotton	3.0	1.18
Carbon black	2.3	2.7
Charcoal	2.67	2.67
Kieselguhr	3.0	

Losses due to the evaporation of oxygen. The time which elapses from the moment of removing the cartridge from the Dewar vessel up to shotfiring affects the explosive considerably, since it weakens with the loss of oxygen. In addition a considerable amount of toxic carbon monoxide may be evolved on explosion. The greatest possible efforts should be made, therefore, to minimize the evaporation of oxygen. This begins immediately after removal of the cartridge from the liquid. The rate of evaporation depends on the type of adsorbent used and the insulation. The larger the specific surface of the adsorbent, the less evaporation occurs; e.g. charcoal and carbon black, with a very large surface, give an explosive which loses oxygen, and thus explosive power, very slowly. On the other hand, sawdust loses oxygen much more quickly, since the oxygen is rather weakly adsorbed. The rate of evaporation of oxygen depends also on the diameter of the cartridges and the stemming.

In the U.S.S.R. an adsorbent of milled cane is used since it has very good adsorptive properties. The relationship between the rate of evaporation of oxygen from the cane cartridges, their diameter, and type of stemming is shown in Table 158.

TABLE 158

Diameter of charge and mode of stemming	Time of evaporation to give combustion	
	to CO ₂	to CO
32 mm in the open	10 min	18 min
180 mm in the open	42 min	70 min
180 mm in the shothole	4 hr	7 hr

Charges of oxyliquid, 33 mm dia., containing carbon black (density about 0.3) give complete combustion to CO₂ within 5 min after removal from liquid oxygen and have a power 15% higher than that of standard dynamite; in 25 min their strength is 35% lower than that of dynamite.

A mixture of kieselguhr and petrol, in the ratio of 60 to 40, has 10% less power than dynamite, with a rate of detonation of approximately 3000 m/sec; after 45 min its power falls to 45% that of dynamite.

Loss of oxygen by evaporation does not particularly affect the rate of detonation of an explosive. For charcoal oxyliquid, for instance (Kast and Haid [96]), the following figures have been found:

After	Rate of detonation
3 min	4930 m/sec
6 min	4670-4750 m/sec
10 min	4780 m/sec

The fall in the rate of detonation is insignificant.

Despite the drawback arising from the need for haste, the loss of power caused by the evaporation of oxygen has a great advantage. In the event of a misfire, the

unfired charge loses its explosive power in a few hours, so that a shothole may be drilled again in the same place.

The other advantage of oxyliquits lies in their safety during transport: the explosives are manufactured on the spot, just before the use. One of their most serious drawbacks, as mentioned before, lies in the fact that an explosive which has lost too much oxygen, may give rise to a considerable amount of toxic carbon monoxide on detonation.

SOME OTHER PEACEFUL APPLICATIONS OF EXPLOSIVES

Among various applications of explosives to engineering work such as tunnel and road building, water front, harbour and river regulation etc., explosive working of metals was recently added to the list of peaceful uses of explosives [97].

Another application is in geological investigation by seismographic methods, much used in the search for underground sources of liquids, such as oil.

These applications, which form the subject matter of specialist books, will not be discussed in the present work.

LITERATURE

1. A. NOBEL, Brit. Pat. 1345 (1867); Swedish Pat. 102 (1867); U.S. Pat. 78317 (1868).
2. A. NOBEL, Brit. Pat. 4179 (1875); U.S. Pat. 175735 (1876).
3. C. J. OHLSSON and J. H. NORRBIN, Swedish Pat. of 31 May 1867.
4. J. TAYLOR and P. F. GAY, *British Coal Mining Explosives*, Newnes, London, 1958.
5. MALLARD and H. LE CHATELIER, *Ann. mines* [8], **4**, 274 (1883); **14**, 197 (1888); **16**, 15 (1890). *Mém. poudres* **2**, 355 (1884-1889).
6. *Réglementation des explosifs à employer dans les mines...*, Paris, 1890; *Mém. poudres* **5**, 39 (1892).
7. According to A. BREYRE and E. KEDESZY, *Z. ges. Schiess- u. Sprengstoffw.* **4**, 1. 22 (1909).
8. SIERSCH, *Osterr. Z. Berg- u. Hüttenw.* **44**, 4 (1896).
9. C. E. BICHEL and METTENGANG, *Z. Berg-, Hütten- u. Salinenw.* **50**, 669 (1902).
10. WILKOSZEWSKI, *Z. ges. Schiess- u. Sprengstoffw.* **2**, 141 (1907).
11. W. WILL, *Z. ges. Schiess- u. Sprengstoffw.* **4**, 323, 343 (1909).
12. J. TAFFANEL and H. DAUTRICHE, *VIIIth Intern. Congress of Chemistry*, New York; H. DAUTRICHE, *Mém. poudres* **15**, 164 (1909-1910); J. TAFFANEL, *Compt. rend.* **151**, 873 (1910).
13. E. LEMAIRE, *Ann. mines* **23**, 649 (1922).
14. W. PAYMAN, *Trans. Inst. Min. Eng., London* **75**, 191 (1928).
15. E. AUDIBERT, *Ann. mines* **15**, 213 (1929).
16. C. E. BICHEL, *New Methods of Testing Explosives*, Griffin & Co., London, 1905.
17. G. S. RICE, *Trans. Amer. Inst. Min. Met. Eng.* **71**, 130 (1925).
18. R. L. GALLOWAY, *A History of Coal Mining in Great Britain*, p. 261, MacMillan & Co., London, 1882.
19. H.M. Commissioners, *Accidents in Mines*, Final Report, H.M.S.O., London, 1886.
20. *Royal Commission on Explosions from Coal Dust in Mines*, H.M.S.O., London, 1894.
21. F. A. ABEL, *Accidents in Mines*, p. 61, Institution of Civil Engineers, London, 1888.
22. T. A. ROGERS, *Colliery Guardian* **202**, 26 (1961).
23. J. FRIPIAT, VIIth International Conference of Safety in Mines Research, Paper No. 33, *Safety*

- in Mines R. B.*, Sheffield, 1952; VIIIth International Conference of Safety in Mines Research, Paper No. 44, *Safety in Mines R. B.*, Sheffield, 1954.
24. W. MACNAB, according to DANIEL, *Dictionnaire des explosifs*, Paris, 1902.
 25. W. CYBULSKI, *The International Mining Congress*, Dortmund, 1935.
 26. V. WATTEYNE and E. LEMAIRE, *Ann. mines Belgique* **16**, 937 (1911); **18**, 781 (1913).
 27. HISCOCK, *Colliery Guardian* **128**, 819 (1924).
 28. T. URBAŃSKI, *Roczniki Chem.* **6**, 838 (1926); *Z. ges. Schiess- u. Sprengstoffw.* **22**, 270 (1927).
 29. E. AUDIBERT, *Ann. mines* **6**, 63 (1924).
 30. W. PAYMAN and H. C. GRIMSHAW, *Safety in Mines Research Board, London* **69** (1931).
 31. BEYLING (Gelsenkirchen), *Safety in Mines Research Board, London* **74** (1932).
 32. E. AUDIBERT, *Comité Central, Note Technique* **22**, 23 (1926).
 33. SEGAY, *Ann. mines Belgique* **30**, 1347 (1929).
 34. T. URBAŃSKI, *Roczniki Chem.* **13**, 130 (1933).
 35. G. S. J. PERROTT, *Ind. Eng. Chem.* **19**, 1293 (1927).
 36. W. PAYMAN, D. W. WOODHEAD and H. TITMAN, *Proc. Roy. Soc. (London)* **A 148**, 604 (1935).
 37. W. PAYMAN and D. W. WOODHEAD, *Proc. Roy. Soc. (London)* **163**, 575 (1937).
 38. L. V. DUBNOV, *Ugol* (1949).
 39. W. CYBULSKI, *Archiwum Górnictwa* No. 4 (1963); *XI Conference Internationale des Directeurs de Stations d'Essais, Aix-le-Bains*, 1963.
 40. H. TITMAN and D. G. WILDE, *Safety in Mines Research Establ.*, Sheffield, 1953, Research Report No. 73.
 41. J. TAYLOR, *Trans. Inst. Min. Eng., London* **109**, 358 (1949-1950).
 42. T. MURATA, *J. Ind. Expl. Soc. Japan* **15**, 1 (1954).
 43. W. PAYMAN and R. W. WHEELER, *Iron Coal Trans. Rev.* **136**, 223 (1938).
 44. J. TAYLOR and J. C. HANCOCK, *Trans. Inst. Min. Eng., London* **106**, 678 (1946-1947).
 45. F. LEBRUN and L. WATERLOT, *Explosifs* **15**, 85 (1962).
 46. W. CYBULSKI, *Komunikat GIG* No. 159 (1954); No. 197 (1957).
 47. W. CYBULSKI, *Komunikat GIG* Nos. 245, 255 (1960).
 48. W. CYBULSKI, *The Investigations into the Phenomenon of Deflagration of Polish Blasting Ammonium Nitrate Explosives*, Sosnowiec, 1937. (In Polish)
 49. W. C. F. SHEPHERD and H. C. GRIMSHAW, *Safety in Mines Research Establ.*, Sheffield, 1954, Research Report No. 8.
 50. P. BEYERSDORFER, *Staub-Explosionen*, Steinkopf, Dresden & Leipzig, 1925.
 51. W. CYBULSKI, *Komunikat GIG* No. 57 (1949).
 52. W. CYBULSKI, *Komunikat GIG* No. 169 (1952); No. 198 (1957); No. 227 (1959).
 53. L. V. DUBNOV, *Predokhranitelnye vzryvchatyye veshchestva v Gornoy Promyshlennosti*, p. 68, Ugletekhizdat, Moskva-Leningrad, 1953.
 54. J. TAYLOR and G. P. SILLITTO, *Trans. Inst. Min. Eng., London* **109**, 991 (1949-1950).
 55. A. KREYENBUHL and R. SARTORIUS *Chimie et industrie*, No. special 245 (1954).
 56. L. HACKSPILL, A. P. ROLLET and LAUFFENBURGIER, *Compt. rend.* **198**, 1231 (1934).
 57. H. AHRENS, *VIIIth Intern. Conference of Directors of Safety in Mines Research*, 1954, paper No. 30.
 58. *Safety in Mines Research Establ.*, London, 1952, H.M.S.O. Research Report No. 65.
 59. K. HINO and M. YOKOGAWA, *Intern. Symposium on Mining Research University of Missouri*, Rolla, Missouri, 1961.
 60. According to V. A. ASSONOV and B. D. ROSSI, *Spravochnik po burovzryvnym robotam*, Ugletekhizdat, Moskva-Leningrad, 1949.
 61. W. CYBULSKI, private information.
 62. J. TAFFANEL, *Z. ges. Schiess- u. Sprengstoffw.* **5**, 305 (1910).
 63. M. PRETTRE, *Mém. poudres* **25**, 531 (1932-1933); **26**, 239 (1934-1935).
 64. E. LEMAIRE, *Ann. mines Belgique* **19**, 587 (1914).

65. J. S. B. FLEMING, Brit. Pat. 416586 (1934).
66. J. TAYLOR, *Colliery Guardian* **179**, 329 (1949); *Trans. Inst. Min. Eng., London* **109**, 2 (1949-1950).
67. J. BOUCARD and L. DEFFET, *Explosifs* **17**, 33 (1964).
68. T. URBAŃSKI, unpublished work (1925).
69. K. HINO, *Theory and Practice of Blasting*, Nippon Kayaku Co. Ltd., 1959.
70. T. URBAŃSKI, *O/Schlesischer Berg- u. Hüttenmän. Vereins Z.* **65**, 217 (1926).
71. A. WETTERHOLM, *Explosives for Rock Blasting*, Atlas Copco AB, Stockholm and Sandvikens Jernverks AB, Sandviken, 1959.
72. W. J. DIXON and A. M. MOOD, *J. Amer. Statistical Assoc.* **43**, 109 (1948); W. J. DIXON and F. J. MASSEY, Jr., *Introduction to Statistical Analysis*, McGraw-Hill, New York, 1951.
73. J. W. GIBSON, H. C. GRIMSHAW and D. W. WOODHEAD, *Safety in Mines Research Establ.* 1952, Research Report No. 47; see also: N. E. HANNA, G. H. DAMON and R. W. VAN DOLAH, *Meeting of the Directors of Safety in Mines Research, CERCHAR*, Verneuil, 1958; U.S. Bureau of Mines, Report of Investigation 5463 (1959).
74. R. L. GRANT and R. W. VAN DOLAH, *University of Missouri School of Mines and Metall. Bull., Technical Series*, 97.
75. e.g. R. L. GRANT, L. M. MASON, G. H. DAMON and R. W. VAN DOLAH, U.S. Bureau of Mines, Report of Investigation 5486 (1959).
76. L'Association de Fabricants Belges d'Explosifs et le Centre de Recherches Scientifiques et Techniques pour l'Industrie des Produits Explosifs, *Explosifs* No. 4 (special) (1958).
77. A. A. PODGORNOVA, in *Novye vzrychatyye veshchestva* (Ed. L. V. DUBNOV), 44/1, p. 64, Gosgortekhzdat, Moskva, 1960.
78. C. SCHWANKE, Ger. Pat. 497212 (1930).
79. *Jahresber. Chem.-Techn. Reichsanstalt* (1929).
80. T. URBAŃSKI, *Chemie und Technologie der Explosivstoffe*, Bd. III, Verlag f. Grundstoffindustrie, Leipzig, 1964.
81. H. AHRENS, *VIIIth International Conference of Safety in Mines Research*, Paper No. 27, Sheffield, 1952.
82. W. CYBULSKI, *Badania detonacji materiałów wybuchowych metodą kamery z wirującym zwierciadłem*, Katowice, 1948.
83. National Coal Board Specification No. P 112/1957, *Permitted Explosives*.
84. A. B. WILDGOOSE, *Colliery Guardian* **202**, 493 (1961).
85. S. YAMAMOTO, *Xth Intern. Conference of Directors of Safety in Mines Research*, Pittsburgh, U.S.A., 1959; *Additional Copies and Supplements*, University of Tokyo, 1959.
86. M. YOKOGAWA, Nippon Kayaku Co. Ltd., private information (1959).
87. T. URBAŃSKI, unpublished work (1925).
88. H. B. LEE and R. L. AKRE, U.S. Pat. 2703528 (1955).
89. S. R. BRINKLEY and W. E. GORDON, *Explosive properties of the ammonium nitrate-fuel oil system*, Hanna Coal Co., Cadiz Ohio, U.S.A.
90. *International Symposium of Mining Research, University of Missouri*, Rolla, Missouri, February 21-24, 1961.
91. C. A. TAYLOR and W. H. RINKENBACH, *U.S. Bureau of Mines Bull.* No. 219 (1923).
92. W. KIRST, C. A. WOODBURY and MCCOY, U.S. Pat. 1992217-7 (1935).
93. E. DEMELENNE, *Ann. mines Belgique* **52**, 56 (1953).
94. R. HASLAM, S. H. DAVIDSON and J. C. HANCOCK, *Trans. Inst. Min. Eng., London* **114**, 87 (1954-1955).
95. C. LINDE, *Sitzungsber. Münch. Akad. Wissenschaft.* **1899**, 65.
96. H. KAST and A. HAID, *Z. angew. Chem.* **37**, 973 (1924).
97. J. S. RINEHART and J. PEARSON, *Explosive Working of Metals*, Pergamon Press, Oxford, 1963.
98. R. WESTWATER, *Colliery Guardian*, February 25, 1966.

CHAPTER VI

THE MANUFACTURE OF MINING EXPLOSIVES

THE MANUFACTURE OF AMMONIUM NITRATE EXPLOSIVES

Raw materials

THE properties and purity standards of ammonium nitrate — a chief ingredient of these mixtures—have been discussed earlier (p. 463, Vol. II), and so has the purity of potassium nitrate (p. 343). The other ingredients should meet the requirements of high purity demanded in the commercial products.

The quality of an explosive depends to a great extent of the uniformity of the mixture, i.e. on the milling of the ingredients and on their mixing. The careful preparation of ingredients is therefore an essential requirement. Mills of the disintegrator type are best suited for this purpose (Excelsior, Perplex etc.). Not infrequently the ingredients are dried before milling. The drying of non-explosive ingredients, such as all salts other than ammonium nitrate, is fairly straightforward. It is usually carried out in ordinary shelf driers heated from below by warm air convection. Since the salts become lumpy on drying, they are then screened, if necessary, being crushed between the rollers before screening. To prevent hygroscopic salts (sodium nitrate, sodium chloride) from absorbing moisture, a temperature of 25–30°C is maintained in the premises.

More recently driers based on the fluid-bed principle were introduced. Figures 160 and 161 give diagrammatic presentations of sodium nitrate and woodmeal fluid-bed driers.

Ammonium nitrate may also be dried in the same driers. Since, however, very large quantities of this substance are processed in factories, the use of a high output drier is necessary. The very low sensitiveness of ammonium nitrate to friction and impact permits the use of steel machinery.

Various drum type driers are very popular. A typical example with a stationary drum is shown in Fig. 162. In this arrangement the substance passes through the mill to the elevating conveyer which carries it to the end of the drier. A screw conveyer inside the drum moves the substance through the drier. Hot air (60–80°C) is sucked from above by a fan. The dried substance is poured into the screening

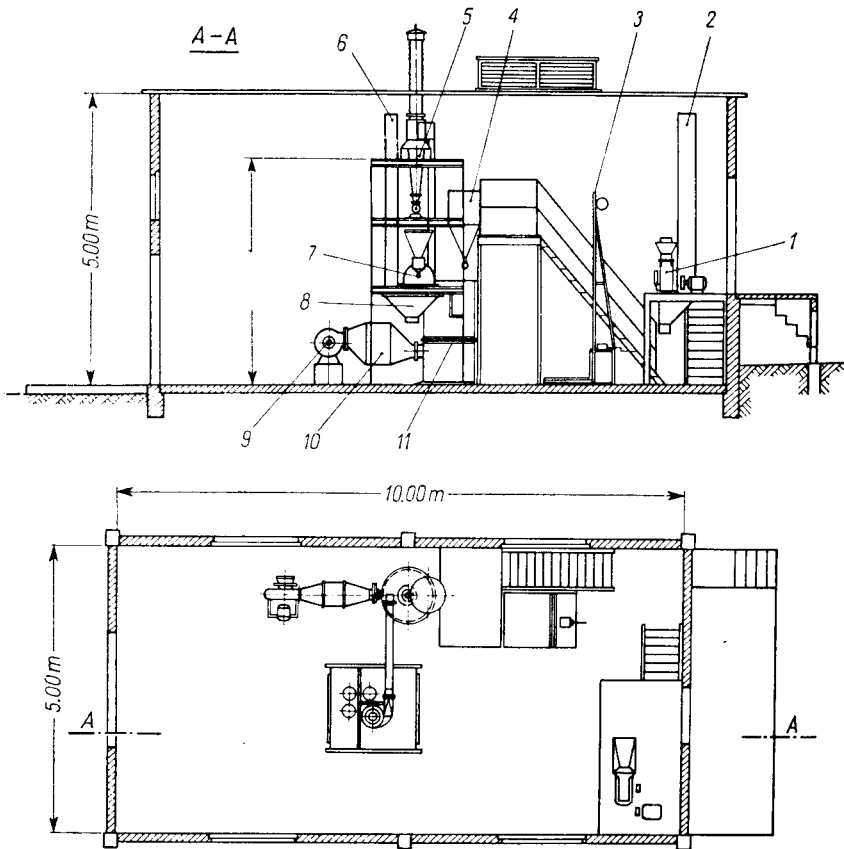

FIG. 160. Sodium nitrate fluid-bed drier (Courtesy H. Orth G.m.b.H., Ludwigshafen-Oggersheim, G.F.R.); 1—filter tube, 2—mill, 3—lift, 4—feeder, 5—outlet cyclone, 6—filter tube, 7—end-mill, 8—discharge funnel, 9—ventilator, 10—calorifuge, 11—fluid-bed drier.

drum. Lumps formed during drying are recycled to the mill and drier. Rotary driers (Fig. 163) and shelf driers of the Schielde type are also in use (Vol. II).

More modern fluid bed driers are now much in use. A diagrammatic presentation of such a drier is given in Fig. 164 and the general view in Fig. 165.

Mixing of ingredients

There are various methods of mixing. They depend on the traditions of a given factory or country and on the ingredients included in the mixture. Explosives containing nitroglycerine are mixed differently from those without nitroglycerine. Nitroglycerine explosives are usually mixed in two stages: first all the ingredients with the exception of nitroglycerine are mixed together and then the nitroglycerine is added in a different mixer.

Mixing of ingredients without nitroglycerine. These may be mixed either cold or hot. In the cold, the ingredients previously dried and milled either in iron drums with wooden balls or in kneaders of the Werner-Pfleiderer type (Figs. 206, 207, 208) are mixed for about 1 hr. In France an edge runner is commonly used of a construction similar to that for the manufacture of blackpowder (Fig. 94). In the edge runner the explosive is not only mixed and milled but also crushed. It may thus reach a higher density which is particularly advantageous when intended for

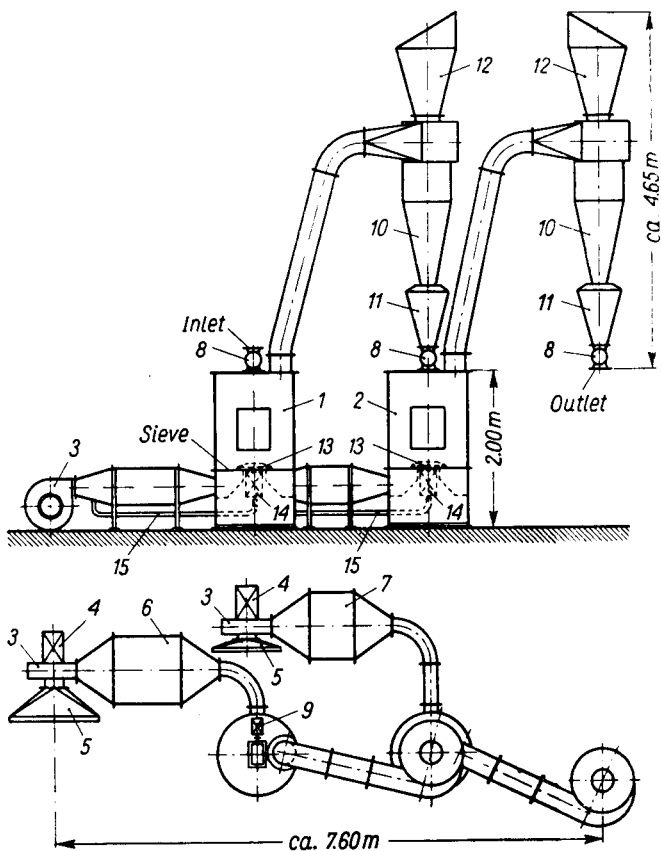

FIG. 161. Woodmeal fluid-bed drier, 200 kg/hr (Courtesy H. Orth G.m.b.H., Ludwigshafen-Oggersheim, G.F.R.); 1—pre-drier, 2—final drier, 3—blowing engine, 4, 9, 14—electric motors, 5—air filter, 6—air heater for the pre-drier, 7—air heater for the final drier, 8—feeding and discharging valves, 10 and 11—cyclones, 12—air stream breakers 13—air screw wheels, 15—air coolers.

military purposes (making Amatol 80/20 for shell filling). Mixing in an edge runner makes it possible to obtain a higher rate of detonation which is of importance for rock explosives and ammonium nitrate mixtures intended for military purposes.

Schneiderite, for instance, consisting of a mixture of ammonium nitrate and dinitronaphthalene, is mixed in an edge runner in batches of 60 kg. The mixing

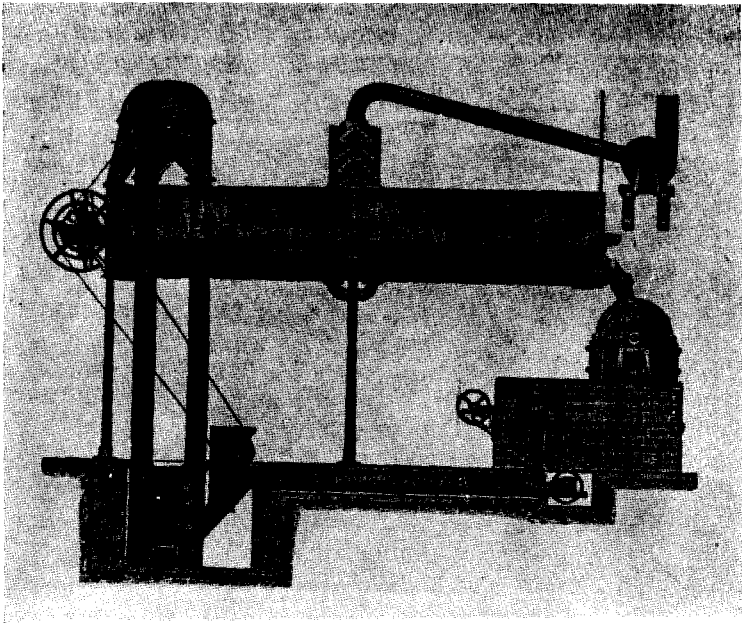

FIG. 162. Schematic view of a drier with a stationary drum.

lasts for about 40 min. Since it is necessary to protect ammonium nitrate against the absorption of atmosphere moisture a temperature of approximately 30°C must be maintained and the material must be dried to about 0.4% moisture content. Two edge runners can manufacture 1500 kg of Schneiderite in 24 hr. If the explosive is to be used for filling shells, and thus requires a considerable density, the charge from the edge runner is sifted through a 5-mm mesh sieve; coarse grains are pressed

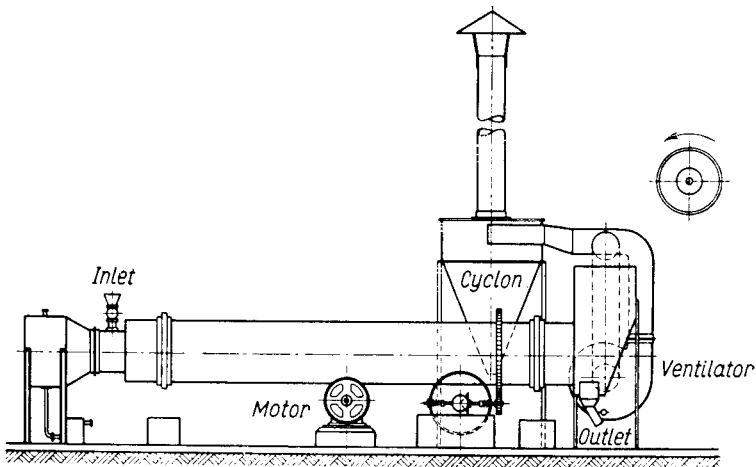

FIG. 163. Schematic view of a rotary drier.

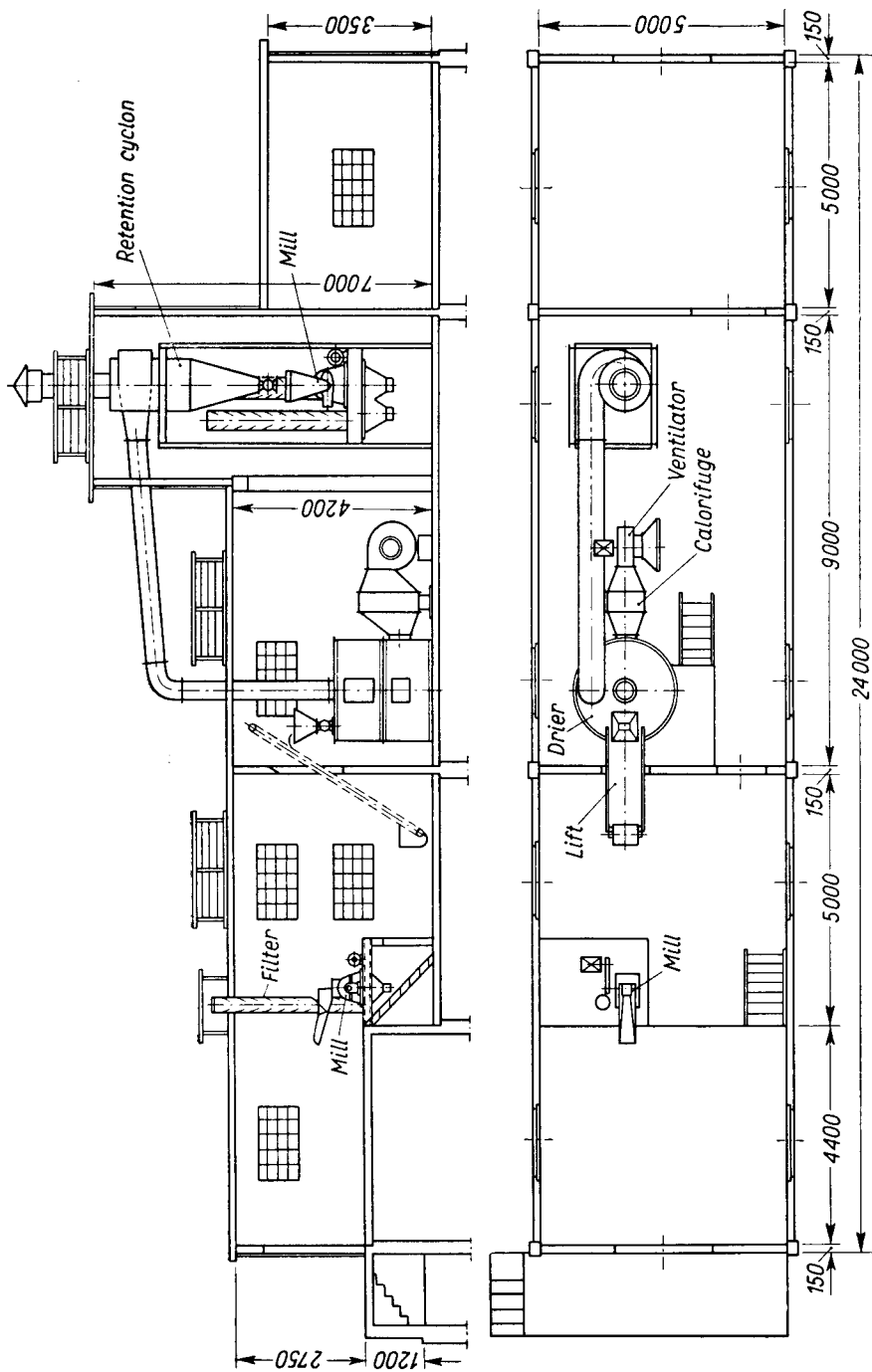

FIG. 164. Diagram of a fluid-bed drier for ammonium nitrate (Courtesy H. Orth G.m.b.H., Ludwigshafen-Oggersheim, G.F.R.).

in a hydraulic press (60 kg/cm²) while fine grains, together with dust, are recycled to the edge runner. The layer of explosive to be pressed must be such as to achieve a thickness of 6.5 mm by the end of the operation.

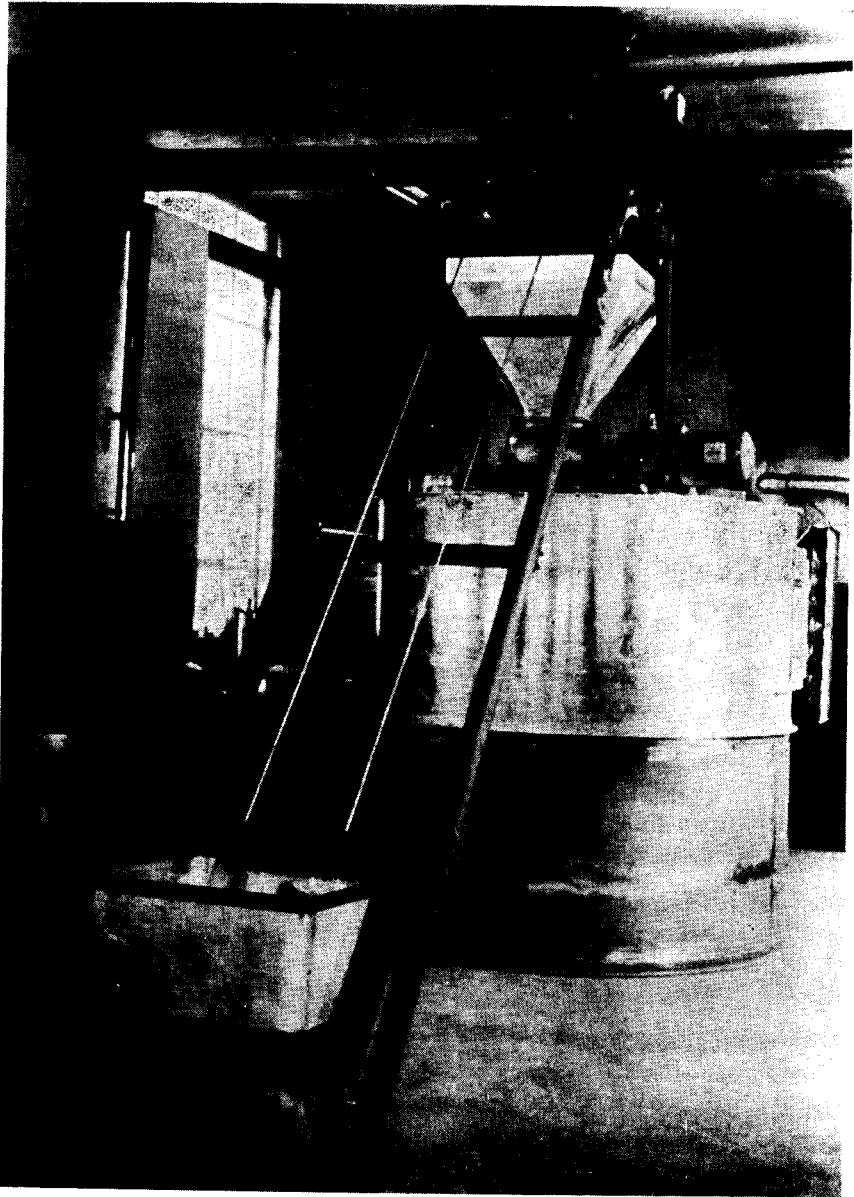

FIG. 165. General view of a fluid-bed drier for ammonium nitrate (Courtesy H. Orth G.m.b.H., Ludwigshafen-Oggersheim, G.F.R.)

The pressed cakes of explosive are broken up in a corning mill, the construction of which is shown in Fig. 166. After passing through breaking rollers (1) and (2) the material passes through a leather sleeve to sieves (3) (13 mm mesh) and (4) (6 mm

mesh). Material with grains of the correct size constitutes 50% of the whole. It is collected in receiver (5). The dust (from container (6)) and coarse grains (from vessel (7)) are recycled to the edge runner.

Schneiderite so obtained has a specific gravity of 1.5–1.6, number of grains per kilogramme 1500–2000 and a rate of detonation approximately 5400 m/sec.

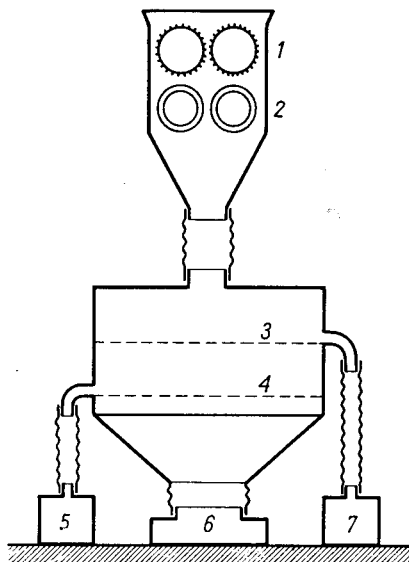

FIG. 166. Schematic view of a corning mill for ammonium nitrate explosive.

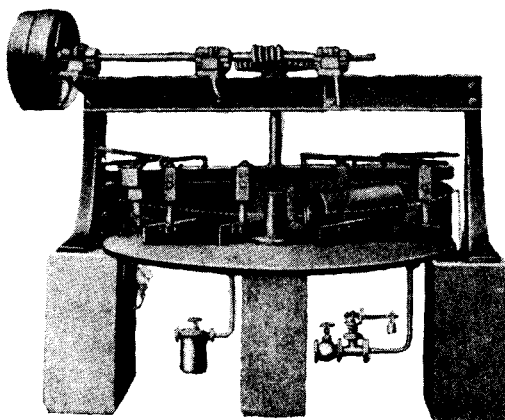

FIG. 167. Disk mixer.

Hot mixing may be conducted either in kneaders of the Werner-Pfleiderer type with a heating jacket or in disk mixers (Fig. 167). These mixers consist of a round plate of copper, brass or bronze, approximately 2 mm dia., with beaded edges, which is heated with hot water to a temperature of 80–90°C. The material is mixed with bronze blades and kneaded with a bronze roller.

The operation in kneaders or disk mixers begins with the mixing of all the ingredients, except those which sensitize the mixture to impact and friction, e.g. potassium or ammonium perchlorates. Molten TNT or another nitro compound (DNT) is then poured in, the whole is carefully stirred and cooled while stirring. Only when the temperature has fallen to 40–50°C, are the perchlorates added. When the material is cooled down to a temperature of 25–30°C, it is stirred for a certain time, then unloaded and transported in sheet metal or wooden boxes to the store-room.

It usually takes a long time (3–4 hr) to cool a mixture, especially when operating the kneaders, so that some factories have adopted a more economic method of mixing by preparing separately, hot, a mixture of ammonium nitrate (two parts) with TNT (one part), called "triamon".

A certain amount of this mixture is stored at temperatures of 25–30°C, to be used cold as the need arises for the preparation of the finished product by one of the methods described above.

Médard and Le Roux [1] examined the influence of various methods of mixing on the properties of ammonium nitrate explosives ("Explosifs du type N"). They found that mixing in heavy (5 ton) edge-runners gives explosives of higher sensitiveness and rate of detonation than the same explosives mixed in kneaders of the Werner-Pfleiderer type.

The difference can be seen from the Table 159 which refers to Explosive N No. 31 (see Table 119).

TABLE 159

	Mixed	
	in kneaders	in edge-runners
Density	0.95	1.00
Sensitiveness to initiation in grammes of fulminate		
at density 1.00	0.30	0.25
1.30	2.00	0.50
1.50	no detonation	0.80
Transmission of detonation (cm)		
at density 1.00	6.5	8
1.30	0.5	4
Rate of detonation (m/sec)		
at density 1.00	3350	3900
1.30	3690	4800

Mixing either hot, or hot and cold alternately, has the advantage over mixing only in the cold that the crystals of ammonium nitrate are coated with a layer of nitro compound due to contact with molten TNT or DNT, which somewhat reduces their hygroscopicity. Mixing in the hot requires careful temperature control as the explosive leaves the kneader or mixer after being cooled. This temperature

should under no circumstances be higher than that of the change of crystal form of ammonium nitrate, i.e. $+32.1^{\circ}\text{C}$ for pure substance. If the explosive has a temperature higher than $+32^{\circ}\text{C}$ after leaving the kneader, the change in crystal form may produce caking in later stages of manufacture, i.e. in the stored boxes or (at worst) in the paper cartridges.

Caking during storage is not of great consequence except that additional screening is then needed. On the other hand, caking in the finished charges is much more serious, since charges of hardened explosive are not suitable for use as their sensitiveness to detonation is impaired and it is difficult to introduce detonators into them.

Mixing of ingredients with nitroglycerine. Ammonium nitrate explosives containing 4–6% nitroglycerine are mixed in two stages. First, all the ingredients other than nitroglycerine are mixed by one of the methods described above and, secondly, nitroglycerine is added at a temperature of $30\text{--}32^{\circ}\text{C}$ and carefully stirred. Mixing can also be carried out at 40°C and ended at 30°C . The temperature change is required for the reason given above. Mixing with nitroglycerine is carried out either in Werner-Pfleiderer (Fig. 206) or Drais type (Fig. 173) kneaders.

Cartridging

Free-flowing ammonium nitrate explosive is loaded into cartridge cases usually 32 mm dia., made of paraffin paper. The cartridge cases are handmade or manufactured on Hesser machines (in which they are numbered and paraffined at once) or on Niepmann machines (Fig. 179). The cartridges generally produced weigh 100 and 50 g. For loading, machines are usually employed in which the explosive is poured into a funnel fitted with a rotating screw that pushes the explosive towards the mouth of the funnel onto which the paper cartridge case is placed. There another rotating screw feeds the explosive into the cartridge case. After filling the open end of the cartridge case it is sealed (Fig. 168).

Paraffining and packaging

Formerly cartridge cases were made of non-paraffined paper and were paraffined after filling by dipping into melted paraffin, lignite wax (montan wax) or a mixture of both. A mixture of paraffin with rosin in the ratio of 70/30–90/10 was preferable to paraffin alone. The amount of coating should not exceed 2.5 g per 100 g of explosive. It was found, however, that paraffin may penetrate too deeply inside the cartridge and desensitize the explosive. Moreover, hot paraffin may induce a change of crystal form in the ammonium nitrate and cause the cartridges to harden. This method was therefore abandoned and the cartridge cases are now paraffined before being filled. The prepared cartridges are then placed into cardboard boxes, wrapped with paper and paraffined, together with the whole box. The latter usually contain 2–2.5 kg of explosive.

To help identify the explosives according to their safety, and to avert serious errors, cartridges are packed in various colours which in Poland are:

rock explosives — red,
 coal explosives — blue,
 permitted explosives — cream-coloured,
 special permitted explosives — cream-coloured
 with the two black stripes and black bordering.

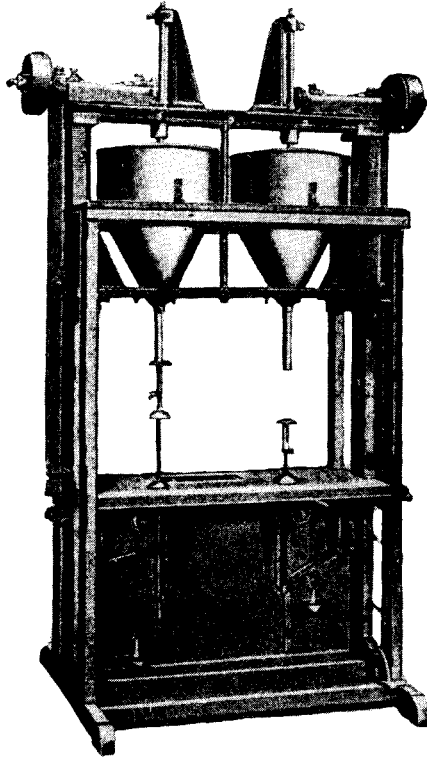

FIG. 168. Cartridging machine for free-pouring mining explosives.

In the U.S.S.R.:

explosives approved for opencast mines have white paper cartridges,
 explosives approved for non-gassy and
 non-dusty mines — red,
 rock explosives approved for gassy and
 dusty mines — blue,
 coal and rock explosives approved for
 gassy and dusty mines — yellow,
 explosives approved for sulphur mines — green.

AMMONIUM NITRATE-FUEL OIL MIXTURES (AN-FO)

Various methods have been used for mixing ammonium nitrate with fuel oil on site at opencast mines. Some were very primitive and consisted of simply adding fuel oil to a polyethylene bag of ammonium nitrate and allowing the mixture to stand long enough for the ammonium nitrate to be soaked with oil. Then the mixture was poured into vertical shotholes.

Another method consisted of charging the shothole with a definite quantity of ammonium nitrate and pouring a measured quantity of fuel into it through a funnel.

Although these methods do not require any special equipment, they cannot guarantee uniform and reliable results.

Some users organized a plant where the AN-FO mixture was prepared, packed into multiwall paper or polyethylene bags, and stored until moved by company trucks to the mine or quarry.

The mixing and packaging equipment and procedures were as follows [2]. Dry ammonium nitrate prills are dumped into a sheet-metal hopper, approximately $4 \times 4 \times 4$ ft in size with a sloping bottom, which feeds a 5 in. pipe through which an auger, driven by an electric motor through reducing pulleys, move the prills past a second, smaller bin into which oil is sprayed. The flow of oil is controlled by a hand-operated valve. A short distance beyond the point at which the oil is added, the auger discharges into a bucket elevator which raises the mixture to the top of a hopper approximately $5 \times 5 \times 5$ ft in size. The top of this hopper is approximately 10 ft above the floor. At the bottom of the hopper, four filling tubes, closed by means of simple slide valves, control the flow of the mixture into packages. Usually the mixture is repackaged into the multiwall paper bags in which the ammonium nitrate had been received or into polyethylene tubes.

Sewing, heat sealing and tying equipment is available for closing the packages of explosive.

Fire followed by a disastrous detonation occurred in a plant near Norton, Va. According to van Dolah and Malesky [2] the accident demonstrated the importance of the many safety recommendations issued earlier by the Bureau of Mines [3]. In brief, all typical safety regulations for explosives factories and stores should be observed, i.e.: blasting agents should not be stored with ammonium nitrate or explosive mixtures, no smoking or open flames should be permitted in any of the buildings, the floors should be cleaned frequently to prevent any accumulation of ammonium nitrate, fuel oil or explosive mixtures, no more than one day's production of fuel-mixed ammonium nitrate should be permitted in or near the mixing and packaging plant, all electrical equipment should conform to safety regulations and all switches, controls, motors etc. should be outside the buildings.

Some opencast mines in the U.S.A. and Canada worked out special equipment for production of AN-FO. Some of these designs are given below, according to the literature [4].

Figure 169 gives an idea of the apparatus which seemed to be in use at Bingham Mine, Utah. It permits charging horizontal, skew and vertical shotholes with an ammonium nitrate-fuel oil mixture. Ammonium nitrate (45.4 kg) is placed in the vessel. Fuel oil (3.78 l.) is introduced from a measuring tank. The ammonium nitrate and fuel oil are moved by compressed air (2.6 and 1.9 atm respectively). Mixing occurs in the lower part of the vessel and immediately afterwards the mixture is fed into the shothole.

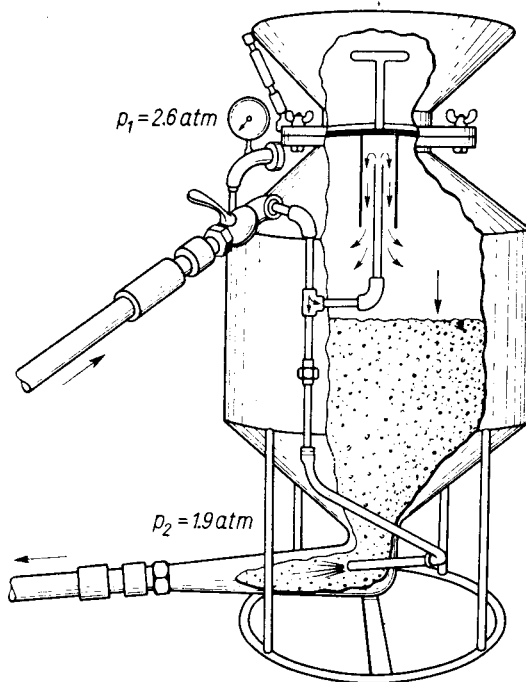

FIG. 169. Diagrammatic presentation of mixing equipment used in Bingham Mine, Utah, U.S.A. [4].

Another design, used in Canada, is shown in Fig. 170. It consists of a funnel provided with a number of nozzles supplying the liquid fuel. Ammonium nitrate passes through a sieve (1) and an exit (2) on a divergent cone (3) into the mixing chamber where the liquid fuel is injected by four nozzles—one of them (4) is shown. Uniform flow of the liquid is automatically maintained.

Another method also used in Canada is presented diagrammatically in Fig. 171. Ammonium nitrate passes through a mill and a sieve (1) and is transported to a mixing house through a stainless steel tube by means of compressed air. Liquid fuel enters the same mixing house from a tank. Mixing occurs in a rotating hopper. The mixture is loaded onto a special lorry (Fig. 172), which is equipped with a compressor, a screw conveyer, and a dosage valve. Shotholes are loaded straight from the lorry. The explosive from the lorry is delivered to the shothole by means of a compressed air.

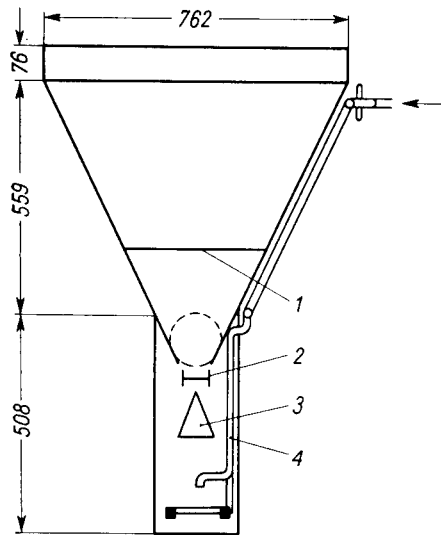

FIG. 170. Diagrammatic presentation of mixing equipment used in Canada [4].

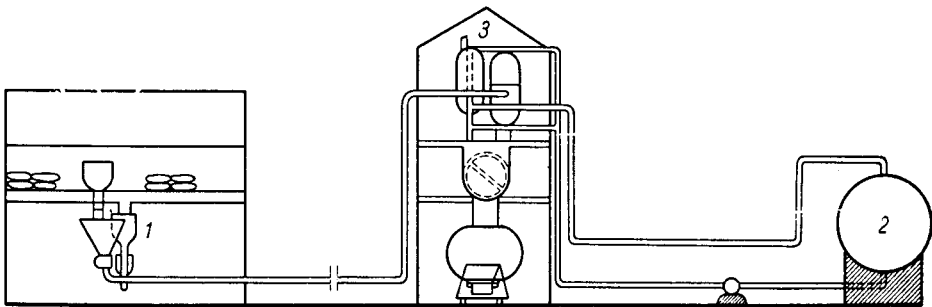

FIG. 171. Diagrammatic presentation of a mixing plant in Canada [4]; 1—ammonium nitrate compartment, 2—fuel oil tank, 3—mixing house.

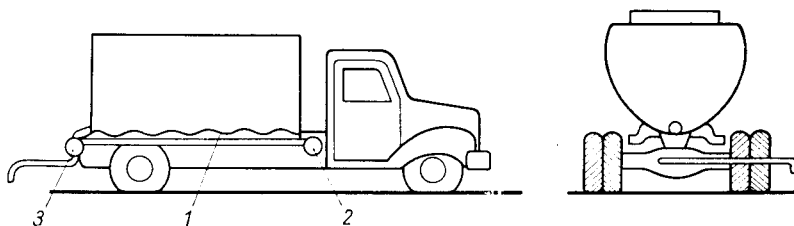

FIG. 172. Lorry for ammonium nitrate-fuel oil explosive [4]; 1—screw conveyer, 2—lifting device, 3—dosage valve.

THE MANUFACTURE OF DYNAMITES

Raw materials

Methods for the manufacture of raw materials of requisite purity for nitroglycerine, nitroglycol and nitrodiethylene glycol production and for dynamite collodion cotton have already been described (Vol. II, pp. 87, 145, 152 and 409).

The oxidizing agents, such as sodium or potassium nitrates, were described in the section on blackpowder (p. 342) and ammonium nitrate in Vol. II, p. 450.

The other ingredients should meet the requirements for commercial products of high purity. Salts should be dried and milled.

Collodion cotton is a dynamite ingredient of very great importance. Before use each lot of collodion cotton should be checked. For this purpose a small sample of blasting gelatine made of nitroglycerine, or of nitroglycerine with nitroglycol used in manufacturing should be prepared. The suitability of nitrocellulose for manufacturing purposes is judged by the properties of the gel, notably by its chemical stability and consistency particularly at an elevated temperature (40–50°C). The gel should not give any exudation of nitroglycerine at this temperature.

Collodion cotton is supplied wet to dynamite factories with a water content up to 30–35%. Some factories use it directly in this form, although the presence of water is detrimental to the uniformity of the gel produced. In the majority of factories nitrocellulose is dried before use.

As will be discussed later (pp. 573, 642) the drying of nitrocellulose is dangerous since when dry it is ignited with unusual readiness by sparks, friction or impact. The drying operation therefore requires great care and is usually carried out in a separate building surrounded by safety walls. The amount of nitrocellulose to be dried at a time must not be too large (less than 100 kg). In the premises a temperature of 45–50°C should be maintained by radiators heated with hot water. The temperature is controlled from outside. The moist nitrocellulose is spread in a thin layer (4–5 mm) over the shelves of wire cloth stretched on carefully-earthed, metallic frames. Wooden frames with muslin stretched over them may also be used, provided that a lower temperature of drying is maintained (e.g. 40°C) and too fast an air circulation (e.g. mechanical ventilation) is avoided, otherwise high static charges may build up on the nitrocellulose. Drying lasts for approximately 24 hr and is ended at a 1.2–2% moisture content since complete drying may be dangerous. After the drying process is completed, the heating is turned off, the drying room opened and the nitrocellulose is unloaded after cooling.

Mixing of ingredients

The dynamite ingredients are mixed with a solution of collodion cotton in nitroglycerine prepared separately or in a mixture of nitroglycerine with nitroglycol. The drying and milling of the ingredients are preparatory operations.

Dissolution of collodion cotton. The collodion cotton used for the manufacture of dynamite gives solutions of very high viscosity. Since it dissolves very slowly, to avoid delays in production, dissolution is usually divided into two stages, viz. initial dissolution and mixing.

Formerly, the initial dissolution was carried out in the following way. Nitroglycerine was weighed in ebonite or bronze cans and was poured into a wooden tub, lined with ebonite or lead sheet, having a capacity of 25 kg of nitroglycerine. Next collodion cotton was poured in and the whole was stirred by hands protected with rubber gloves so as to obtain a mass as uniform as possible. The contents of the tub were allowed to stand for a few hours (the last batches over-night). During this time the nitrocellulose dissolved in the nitroglycerine and the mass became transparent, but not yet uniform. A uniform solution was obtained only by using stirrers or kneaders.

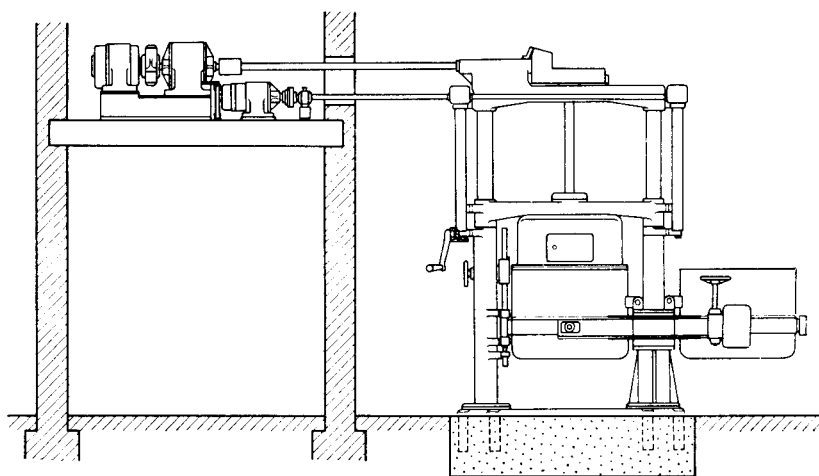
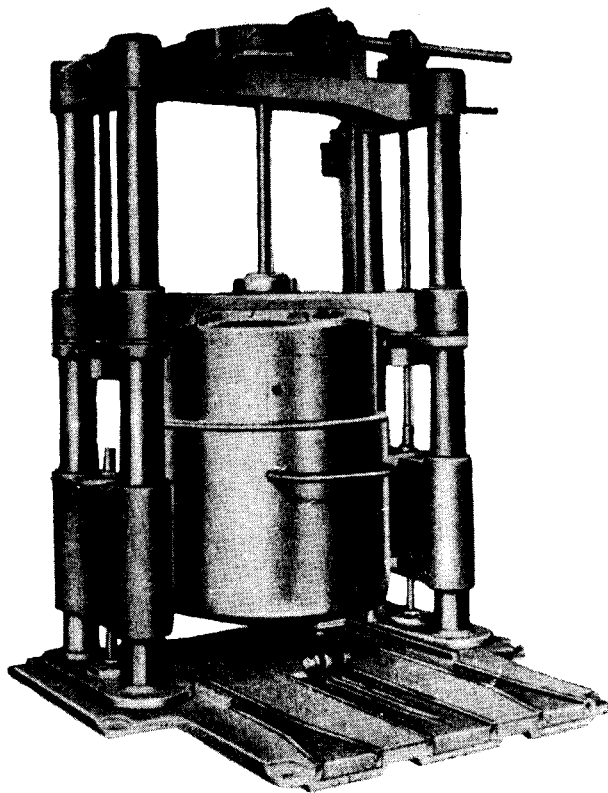

FIG. 173. Diagrammatic illustration of a Drais mixing and kneading machine with two tanks. The drive and switchgear is in an adjacent room for safety reasons (Courtesy Draiswerke Maschinenfabrik G.m.b.H., Mannheim-Waldhof, G.F.R.).

The initial dissolution is now usually carried out in copper tubs with a water jacket which maintains a temperature of 45–50°C in the tub. The tubs contain 100 kg of a mixture of nitroglycerine and nitrocellulose. Their contents are stirred with wooden paddles and then allowed to stand for 20–30 min. This is sufficient time for complete dissolution of nitrocellulose at this temperature.

Mixing. For mixing the solution of collodion cotton with the other dynamite ingredients vertical kneaders of the Drais type are commonly used (Figs. 173 and 174). The kneader of this type consists of stirrers and a vertical cylindrical tank provided with thermal insulation. The stirrers are fitted with a mechanism enabling them to be lifted and lowered. The toothed wheels which drive the mechanism are



a)

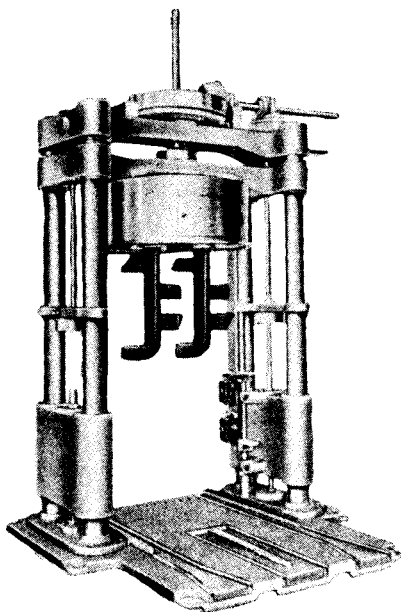

b)

FIG. 174. General view of a Drais mixing and kneading machine (Courtesy Draiswerke Maschinenfabrik G.m.b.H., Mannheim-Waldhof, G.F.R.); *a*—with stirrers dipped in the tank, *b*—with stirrers lifted, tank removed.

protected from dust by means of an air-tight casing. Drais type kneaders with two or three replaceable tanks are also known (Fig. 175).

The tanks have a capacity of 300–450 l. and hold approximately 200–300 kg of dynamite. They are suitable for the initial dissolution of collodion cotton (in a separate room) and for efficient mixing of the collodion cotton with nitroglycerine by hand (in rubber gloves) or with a hand-operated paddle. After the initial dissolu-

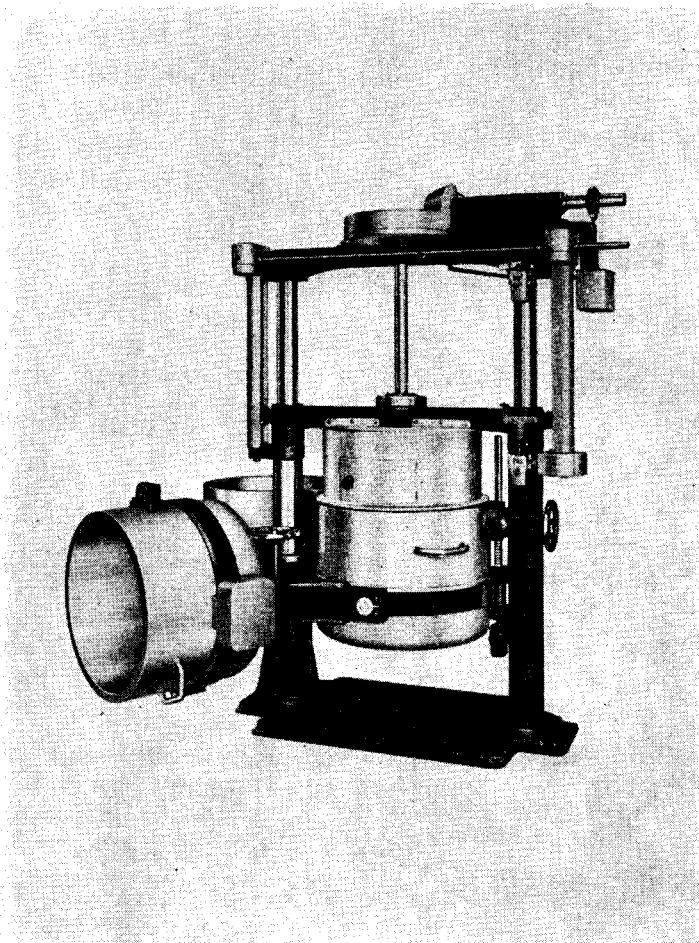

FIG. 175. Drais mixing and kneading machine with three tanks (Courtesy Draiswerke Maschinenfabrik G.m.b.H., Mannheim-Waldhof, G.F.R.).

tion stage the tank is moved to the stirring equipment, where the other ingredients are added and the final mixing is carried out. The remaining dynamite ingredients are then added and stirred with the same stirrers. Since one set of stirrers is provided for several tanks, continuity of work may be maintained and the prolonged initial dissolution does not cause any delays in the manufacture.

For the manufacture of dynamites, kneaders of the Werner-Pfleiderer type may also be employed. They are widely used in the manufacture of smokeless powder (Fig. 206). Drais kneaders however, have the advantage over the Werner-Pfleiderer type in that they are safer to handle, and hence more suitable for mixing materials sensitive to friction and impact, such as dynamites.

Safety in the operation of vertical kneaders is achieved by ensuring that:

(1) The points where there is friction between the stirrers and their bearings are not in contact with the explosive mass.

(2) The distance between the paddles and the interior of the vat in which the stirring is carried out is relatively large.

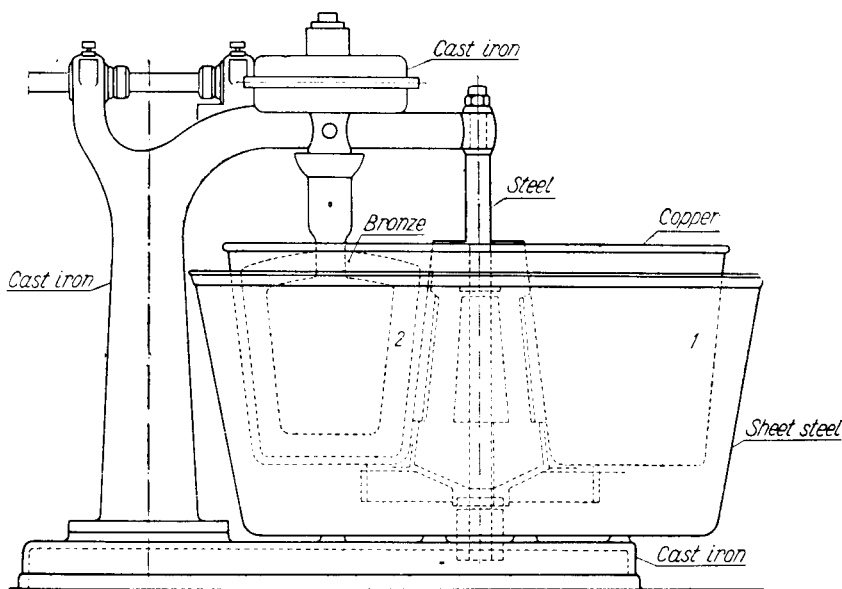

FIG. 176. A kneader used in France for the manufacture of blasting gelatine and dynamites [5].

In Werner-Pfleiderer kneaders this distance is very small so that if a hard object (metallic part, screw, nut etc.) penetrates into a kneader, an explosion may occur due to seizing. Werner-Pfleiderer kneaders have a capacity of 50–200 kg of dynamite.

In some countries other types of plant are used for mixing dynamites. In France, for instance, a kneader constructed as shown in Fig. 176 is used for the manufacture of blasting gelatine and dynamites rich in nitroglycerine. Here a copper vat (1), lined with lead and located in a heating jacket of sheet steel, rotates about a vertical axis. A bronze stirrer, (2), can rotate about another vertical axis. The charge in the kneader is 166 kg of nitroglycerine and 11–12 kg of collodion cotton. At the beginning a temperature of 15–20°C is maintained and it is then raised to 45–50°C.

After 15 min during which the collodion cotton is dissolved, the remaining

ingredients (e.g. 24 kg of potassium nitrate) are added. After stirring, the contents of the vat are cooled to a temperature of 20–25°C.

For mixing dynamites, in particular those containing less nitroglycerine, wooden edge runners of a special design are employed in France (Fig. 177). The tub (1) has the base of ebonite plates (2). The wheels of the runner are also covered with ebonite bands (3).

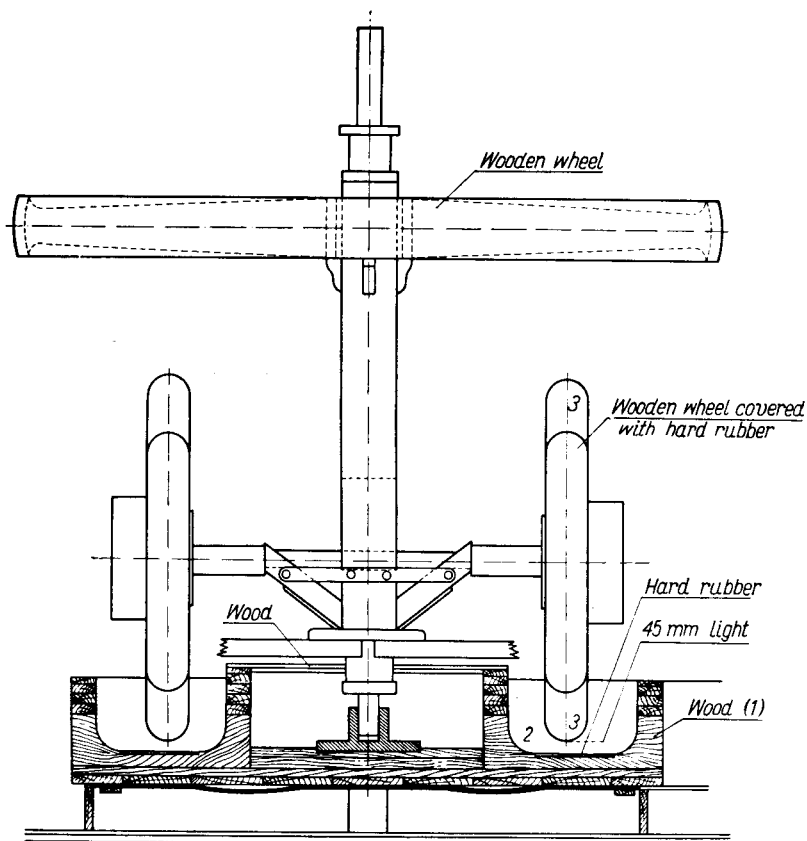

FIG. 177. Wooden edge runner for the manufacture of dynamite [5].

Cartridging

Dynamite from edge runners is transported in trucks to a separate room for cartridging. Figure 178 represents a diagram of one of the oldest and simplest designs for a hand operated machine for cartridging. Dynamite of plastic consistency is loaded by hand into the tapered body (1), through funnel (2). The rotation of the crank handle driving shaft (4) with worm (5) pushes out the explosive mass through the nozzle (3). There are ribs (6) inside the tapered body which prevent the mass from

turning. The mass in funnel (2) should be pressed with a peg to facilitate its exit through nozzle (3). This nozzle has a brass orifice that holds a paper cartridge case. The dynamite passes through the orifice, pushing the bottom of the paper cartridge case and filling it while in motion. When the paper cartridge case has moved forward a distance corresponding to the required length of the cartridge, the dynamite is cut off and the cartridge closes. A new paper cartridge case is then attached to the orifice and the operation is repeated.

The explosive may also be extruded in the form of a long rod which is then cut into pieces of the required length on a table covered with a copper or brass sheet. The pieces are then put into paper cartridge cases which should be made of paraffined paper.

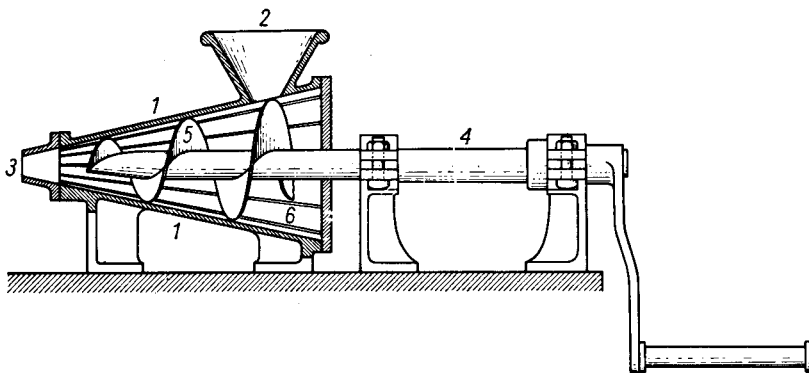

FIG. 178. Machine for the cartridgeing of dynamite [6].

In machines of the design described above a certain danger is created by the pressure caused by the decreasing area of taper. The increase of the pressure leads to greater friction and this, in turn, may cause the ignition of the dynamite. In a machine of better design, therefore, the body in which the worm rotates is cylindrical. It may be equipped with several brass orifices, so that several cases may be cartridgeed at a time. Since this attachment is safer, it may be fitted with a power drive. Loading the funnel with dynamite and fitting the orifices are the only manual operations.

Highly efficient machines are also available for mechanized cartridgeing. In the U.S.A., for instance, there are machines in use, operated by two people and capable of processing 6800 kg of dynamite in 8 hr. Mechanization, however, is not always advisable since it may decrease safety.

In Germany a machine of the Niepmann type has been adapted for cartridgeing dynamite [7]. A schematic view of its operation is shown in Fig. 179. The explosive supplied through funnel (1) is pushed out through worm (2) into conduits (4) and (5), from which it is ejected by pistons (3). The empty paper cases are fed by conveyer (9) into slots on the rotating table (7). When the cases reach position (8), a charge of plastic material, extruded from the orifice (6), is slipped into them. Further rotation severs the rods of dynamite while the cases, already filled, are passed to

slanting receptacles (11) and (12). As there are few movable parts this method of cartridgeing is fairly safe. The machine processes 2400 cartridges of 100 g each, per hour.

A general view of a modern dynamite plant in the U.S.A. is given in Fig. 180.

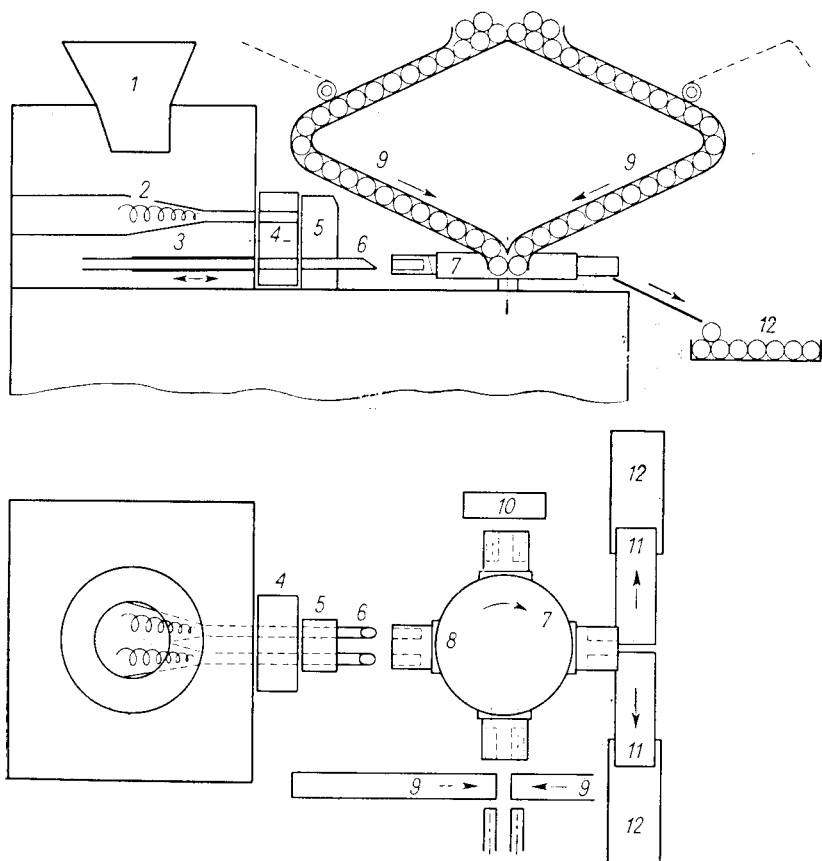

FIG. 179. Schematic view of the operation of a Niepmann type machine for dynamite cartridgeing [7].

Thawing of dynamites

Dynamites that contain nitroglycerine but no nitroglycol can easily freeze at low temperatures. Temperatures below 6°C should be regarded as undesirable and any temperature below 0°C will freeze the dynamite cartridges.

Although crystalline nitroglycerine is less sensitive to shock and can detonate at a higher rate than the liquid substance, the hard frozen cartridges are troublesome to handle, as it is difficult to insert a detonator into them. When such cartridges are warmed crystalline nitroglycerine separates from the gel as it melts and readily flows out of the cartridges. This can create a danger as nitroglycerine spilled on to the floor is subject to shock and friction.

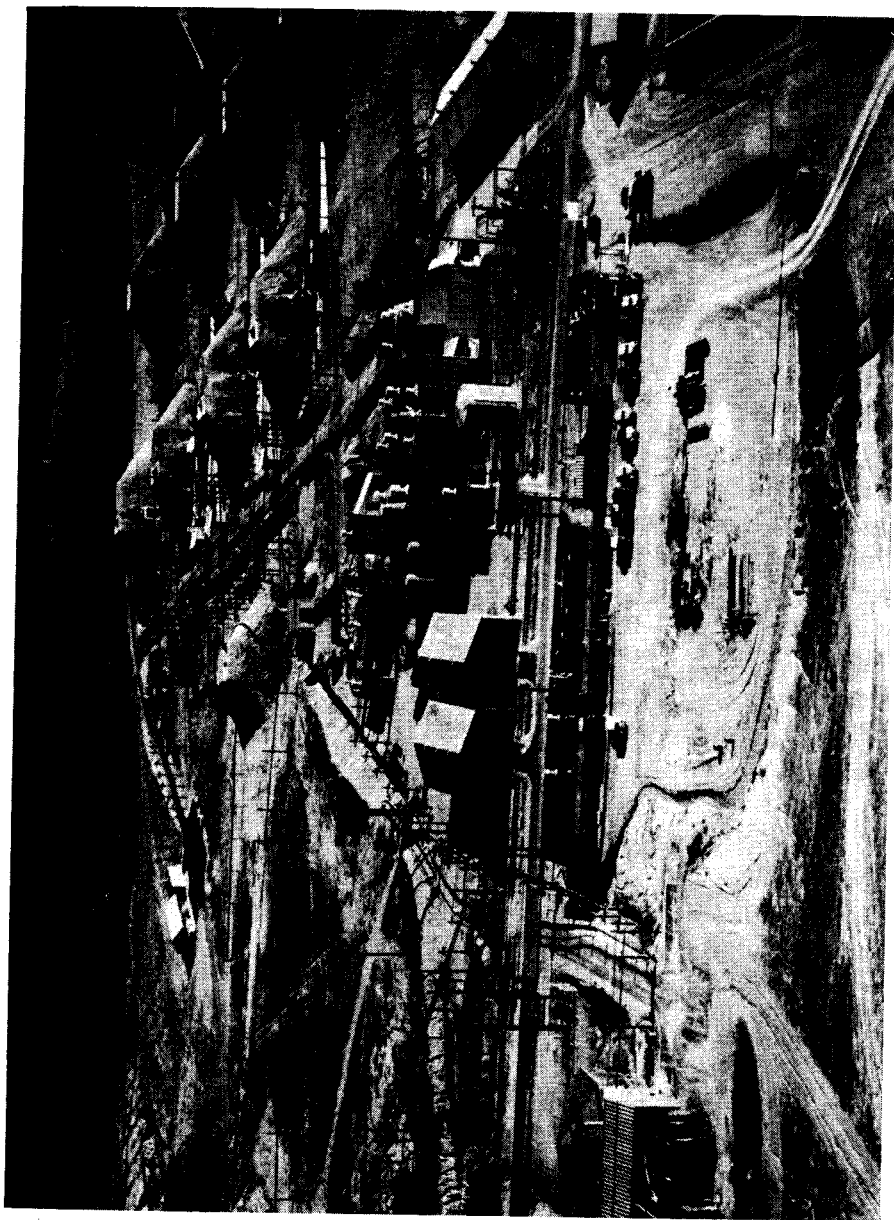

FIG. 180. General view of a modern dynamite plant of du Pont de Nemours in West Virginia, U.S.A.
(Courtesy du Pont de Nemours).

Several accidents have occurred in the course of thawing frozen dynamite cartridges. In France, 1250 kg of dynamite caught fire and detonation occurred in a coal mine at Merlebach, in 1925. Commission des Substances Explosives [8] investigated the accident. The wooden cases with frozen dynamite were placed over steam heated calorifuges. In spite of the fact that the temperature in the compartment for defreezing the dynamite did not exceed 21°C, according to the recording thermometer, the dynamite caught fire after 40 hours' warming. Most likely this was due to superheating.

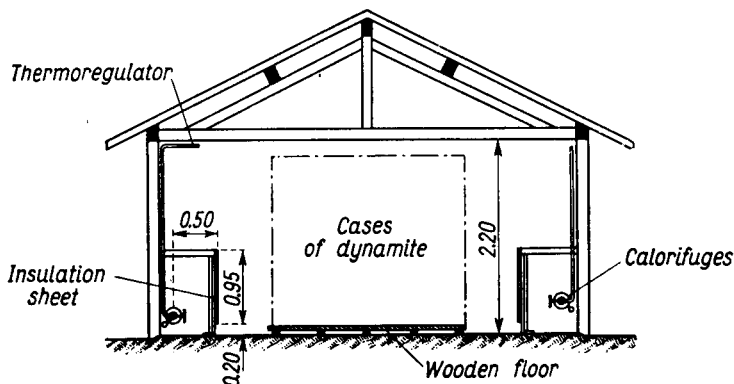

FIG. 181. Schematic design of a building for thawing (decongelation) of dynamites [8].

The Commission recommended several safety precautions, such as:

- (1) keeping the temperature of calorifuges below 100°C preferably by heating with hot water to *ca.* 50°C,
- (2) keeping the temperature inside the defreezing compartment below 30°C,
- (3) using compartments for thawing dynamite so designed that the cases containing explosive are placed away from the calorifuges (Fig. 181).

Although modern dynamites contain mixtures of nitroglycol-nitroglycerine they should be considered to be only comparatively unaffected by a low temperature. Particularly heavy frost may freeze these explosives and the recommendations of the Commission des Substances Explosives should be observed.

THE MANUFACTURE OF CHLORATE AND PERCHLORATE EXPLOSIVES

To avert the danger arising from the mechanization of mixing appliances, chlorate mixtures are usually prepared either by primitive manual methods or in machines made chiefly of wood.

Chlorate explosives of the Cheddite type (p. 277, Table 61) are manufactured in an enamelled vat with a double bottom, heated by steam. First the organic in-

redients are mixed and melted at 80°C (e.g. nitro compound with castor oil, paraffin with vaseline etc.). Finely-crushed chlorate is then added while stirring continuously with a wooden paddle. After a uniform mixture has been obtained, the hot mass is discharged onto a table covered with sheet brass and rolled with a wooden roller. As the mass solidifies, it becomes brittle and crumbles. It is then rubbed through a sieve. Finally the sieved mass is graded by sifting out the dust which is recycled.

If the explosive contains a liquid organic substance, it is prepared, as stated above, by filling the paper cases with chlorate and dipping them into the liquid.

Miedziankit is manufactured in this way, i.e. the milled and dried potassium chlorate is filled into paper cases by the machines for cartridgeing (Fig. 168). The cases are made either of non-glued, absorbent paper or of ordinary, densely-perforated paper. The cartridges filled with chlorate (90 g of weight and 30 mm dia.) are taken to another room in which they are saturated with kerosene. Here troughs mechanically fed with kerosene from a movable tank are placed on tables. The cartridges of chlorate are put into the troughs which rotate every few minutes so that each cartridge is uniformly saturated. After half an hour, when the cartridges are sufficiently saturated with liquid, they are taken out of the troughs and placed in containers made of parchment paper.

Careful, fine milling of the potassium chlorate is a very important factor in the manufacture of chlorate explosives. Opinions are divided on the question of the safety of the milling of chlorate. In Germany chlorate is milled like ammonium nitrate in common mills of the disintegrator type. A pre-requisite for such a procedure, however, is a high purity of chlorate (free from traces of combustible material, especially organic substances); milling impure chlorate is exceedingly dangerous. In France wooden edge runners are used for milling chlorate similar to those for dynamite (Fig. 177).

When manufacturing chlorate explosives, it is of extreme importance to observe the safety code which demands the highest possible purity, the removal of all chlorate dust settling on furniture, clothes etc. The workers' foot-wear should be wooden soled, since nails in soles not infrequently cause accidents. The floor in the premises should be covered with linoleum or magnesia cement.

The manufacture of perchlorate explosives is similar, but due to the lower sensitiveness to impact of perchlorate explosives, some operations as e.g. mixing, may be conducted in Drais kneaders (Figs. 173-175) or even in kneaders of Werner-Pfleiderer type (Figs. 206-208).

CARDOX, HYDROX AND AIRDOX CARTRIDGES

The hazards involved in the use of explosives in coal mining have necessitated constant efforts to improve the safety of blasting in coal mines, using other methods, i.e. the Cardox, Hydrox and Airdox methods of blasting. The Cardox and Hydrox cartridges function in a way similar to explosives.

Cardox. These are steel cartridges (Fig. 182) containing liquified or solidified gas and a pyrotechnic composition. On burning, the pyrotechnic mass emits a great amount of heat and converts the liquid or solid into a gas at a high pressure sufficient to blow out the walls of the shothole. Cardox was invented in the U.S.A. in 1920

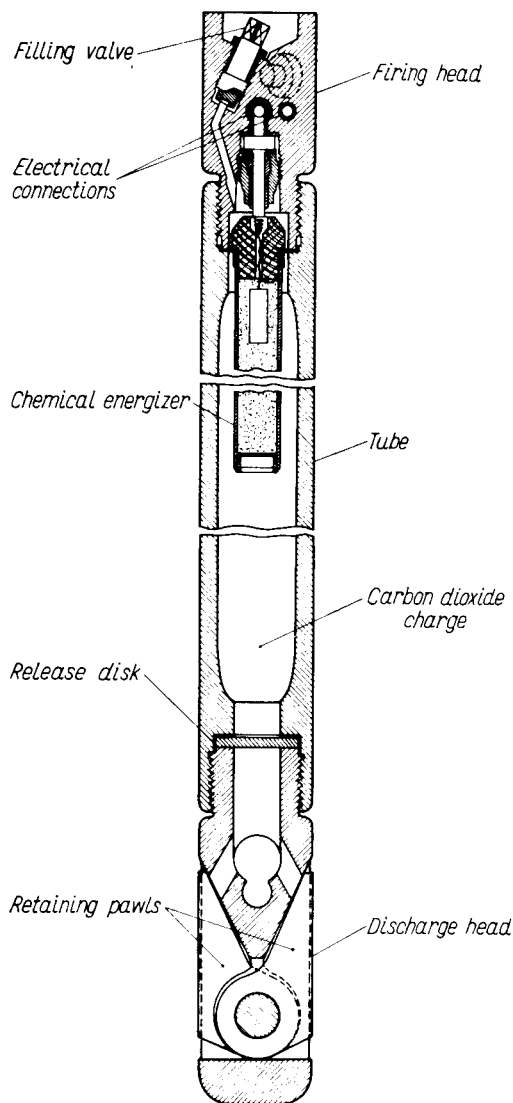
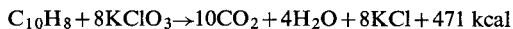

FIG. 182. Cardox blasting cartridge, according to J. Taylor and Gay [9].

by Helmholtz, Farrel and Crawford and received Bureau of Mines U.S.A. approval in 1928 [10].

In Cardox charges liquid carbon dioxide is the ingredient providing the gas pressure. The pyrotechnic charge consists of chlorate mixtures that evolve a great amount of heat, such as either sodium chlorate, powdered charcoal and aluminium

dust or 10% naphthalene and 90% potassium chlorate. The mass is ignited by an electric detonator. The reaction proceeds according to the equation:



In Great Britain a safer mixture was evolved (Payman [11]) with the following composition:

Potassium perchlorate	85%
Asbestos	1.5%
Nitrotoluene	4.5%
Kerosene	8.5%
Castor oil	0.5%

or

Potassium perchlorate	84%
Phenol-formaldehyde resins	16%

Due to the heat of reaction carbon dioxide evaporates very quickly. A high pressure (700–2000 atm) is produced which blows out a steel disk closing the chamber. Theoretically the pressure may increase to 4000–5000 atm. The steel cartridge is used again since it is not destroyed. Due to high cost the use of Cardox has nearly disappeared.

Hydrox. Hydrox charges (Fig. 183) are loaded with a mixture that usually consists of 56% sodium nitrite and 44% ammonium chloride. They carry a charge of cap mixture ignited electrically, the composition of which is similar to that of pyrotechnic mixtures. The heat of combustion of the latter charge causes the mixture of sodium nitrite and ammonium chloride to react according to the equation:

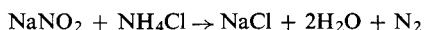

Another possible reaction mechanism is:

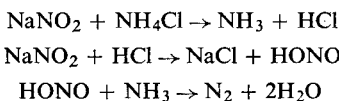

The pressure of nitrogen and steam produced shears the bursting disk and releases the gases into the shothole.

The reaction may stop at an intermediate phase. In fact, the presence of ammonia can usually be detected in the reaction products.

Theoretically reaction takes place at a temperature of 1300°C. In reality the temperature in the cartridge only slightly exceeds 800°C due to its high thermal capacity.

Since the temperature may become too high in certain cases and may cause the ignition of methane in mines (especially when the cartridge is defectively assembled, without the bursting disk, that encloses the charge) a mixture of ammonium nitrate with organic combustible substances and salt hydrates is sometimes employed. Such a mixture is incapable of self-sustained reaction at atmospheric pressure but will decompose in the cartridge, when the pressure rise due to the combustion of an initiating charge composed of guanidine nitrate and an alkali metal persulphate. The initiating charge is fired by a pyrotechnic mixture, initiated, in turn, by means of an electric current.

About 1953 a modification of the Hydrox device, called Chemechol, was introduced in the U.S.A. In this design the electric detonator of the initiator is protected from ignition by stray currents. By this method a pressure of 18,000–22,000 lb per sq. in. (1200–1500 kg/cm²) is attained. However it has been withdrawn from the market mainly due to high costs.

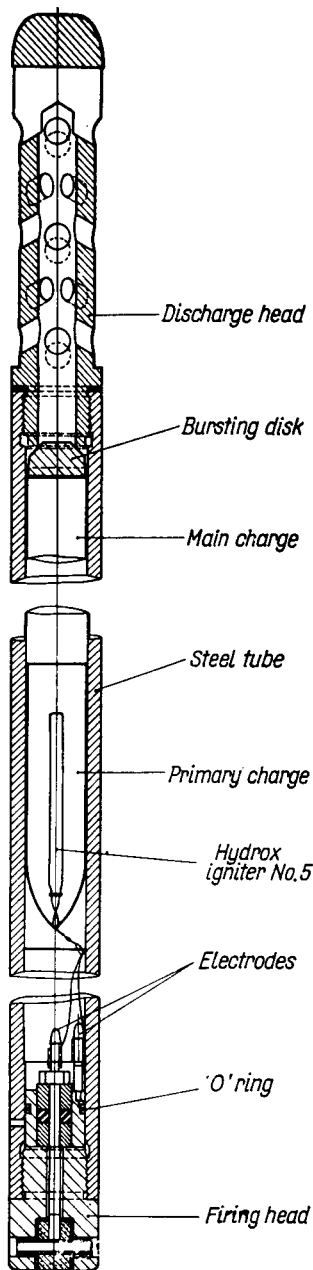

FIG. 183. Hydrox blasting cartridge, according to J. Taylor and Gay [9].

A mixture of sodium nitrite with ammonium chloride may decompose with time to form unstable ammonium nitrite. The presence of moisture and of acids favours the decomposition of a mixture of sodium nitrite with ammonium chloride. On the other hand, alkaline reaction and absence of moisture stabilize the system. Experiments have shown that for all practical purposes the mixture is best stabilized by the addition of 2% sodium carbonate. Ammonium carbonate or magnesium oxide may also be used.

Thermochemical data on a Hydrox mixture stabilized with the addition of 2% sodium carbonate are tabulated below (according to J. Taylor [12]).

TABLE 160

State of water	Conditions	Heat of reaction at 25°C kcal/kg	Temperature of reaction °C	Gas volume l./kg
Vapour	constant pressure	420	1120	537
Liquid	constant pressure	589	1120	
Vapour	constant pressure	435	1310	537
Liquid	constant pressure	594	1310	

Products of complete reaction of Hydrox mixture are:

NaCl	46.7%
N ₂	22.4%
H ₂ O	28.8%
Na ₂ CO ₃	2.1%

The total amount of gas produced comprises 51.2% (by weight) of all products.

A Hydrox mixture can be initiated either by heating it at one point by a heat-producing fuse, by an electrically-heated wire or a blackpowder igniter. A few drops of acid produce a self-sustained reaction, after an induction period. The induction period depends on the nature of the acid solution, its concentration and on the amount of alkaline stabilizer in the Hydrox powder.

Concentrated hydrochloric acid induces vigorous reactions which are partly "Hydrox reactions", and partly reactions which give rise to the evolution of NO (according to J. Taylor [12]).

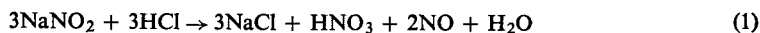

Neither hydrochloric nor nitric acid initiates a self-sustained reaction in powder stabilized with sodium carbonate or magnesium oxide.

This is probably caused by resulting reactions which destroy the acids too rapidly.

J. Taylor has described a method of igniting Hydrox powder stabilized with 2% sodium carbonate: it consists of adding 0.2 cm³ of 50% solution of chromic acid.

Both Cardox and Hydrox devices should be subjected to tests before permission is granted for their use in coal mines, because the essential components of these devices are mixtures similar in nature to explosives. Faulty assembly, such as omission of a bursting disk may bring hot gases in contact with a methane-air mixture or coal-dust.

The greatest advantage of Cardox and Hydrox methods lies in their safety towards methane and coal-dust. They also contribute to the getting of coal in large pieces. In comparison with explosives, however, shotfiring with Cardox and Hydrox devices is more expensive.

Before World War II, in the U.S.S.R, another kind of Hydrox was suggested by Komar [13]. It consisted of modifying Cardox cartridges by replacing carbon dioxide with water. Water has a critical temperature (374°C) and total heat of evaporation much above the critical temperature (31°C) and heat of evaporation of carbon dioxide. Therefore water requires a much higher heat to be supplied by the burning composition. This created difficulty and therefore Hydrox with water did not seem practicable.

Podbelskii [14] suggested using salts which readily undergo dissociation into gaseous products instead of carbon dioxide.

Airdox. The use of Airdox charges is based upon an entirely different principle. A steel cartridge, closed at one end and connected with an air-compressor at the other, is introduced into the shothole. The air is fed in up to 700 atm and when it reaches the required pressure the bursting disk closing the charge is ejected so that the air is discharged and the shothole shattered.

The Airdox method was introduced in mines in the U.S.A. in the early 1930s.

Towards 1938 a modification of this method was introduced under the name of the Armstrong Airbreaker [9]. In this system the air is compressed up to 800 kg/cm² and introduced by opening a blow-out valve; this ruptures the bursting disk and blows up the shothole.

The Airdox device is very safe towards methane and coal-dust. Safety is especially increased by the improvement of the bursting disk which is fitted with a plastic plug closing the charge.

The Airdox device is widely used in the U.S.A. The Armstrong Airbreaker has been employed in very gassy mines in Great Britain, France the U.S.A. and Poland.

LITERATURE

1. L. MÉDARD and A. LE ROUX, *Mém. poudres* 34, 195 (1952).
2. According to R. W. VAN DOLAH and J. S. MALESKY, U.S. Bureau of Mines Report of Investigation 6015 (1962).
3. U.S. Bureau of Mines Information Circulars 7988 (1960) and 8179 (1963).
4. L. I. BARON, G. P. DEMIDYUK and N. F. ADRYANOV, in *Vzryvnoye delo*, No. 45/2 (*Novoye v teorii i praktike vzryvnykh rabot*), ed. L. N. MARCHENKO, Gosgortekhzdat, Moskva, 1960.

5. L. VENNIN, E. BURLOT and H. LÉCORCHÉ, *Les Poudres et Explosifs*, Béranger, Paris-Liège, 1932.
6. O. GUTTMANN, *Die Industrie der Explosivstoffe*, Vieweg & Sohn, Braunschweig, 1895.
7. BIOS Final Report 833, Investigation of German Commercial Explosives Industry.
8. Commission des Substances Explosives, *Ann. mines* 9 (1927).
9. J. TAYLOR and P. F. GAY, *British Coal Mining Explosives*, Newnes, London, 1958.
10. U.S. Bureau of Mines Report of Investigation 2947 (1929).
11. W. PAYMAN, *Iron Coal Trans. Rev.* 121, 448 (1930).
12. J. TAYLOR, *Solid Propellants and Exothermic Compositions*, Newnes, London, 1959.
13. According to V. A. ASSONOV, *Svoistva i tekhnologiya vzryvchatykh materialov*, ONTI, Moskva-Leningrad, 1938.
14. G. N. POBBELSKII, *Ugol* No. 3 (1948).

CHAPTER VII

SMOKELESS POWDER

HISTORICAL

A FEW years after the discovery that the treating of cellulose with nitric acid converts it into a combustible substance, the idea arose of using nitrocellulose as a propellant instead of blackpowder. Schönbein's experiments [1], repeated by Pelouze [2], showed the high energy of nitrocellulose. It was found that a charge of nitrocellulose endows a projectile with a penetrating effect similar to that of a triple charge of blackpowder.

The primary difficulty in exploiting this property lay in finding a method for manufacturing nitrocellulose. It was not until large-scale manufacture of nitrocellulose was achieved by Lenk [3] that propellant charges could be used for Austrian artillery. Shortly afterwards, however, this method proved to be unsatisfactory, due to the variable results obtained and to the excessive pressure developed when firing nitrocellulose charges, which in many instances damaged or even blew up the cannon.

Earlier observations that nitrocellulose burns very quickly in a confined space—much more quickly than blackpowder—were confirmed. Since it is difficult to reduce the burning rate by physical methods only, e.g. by compressing the nitrocellulose to increase its density, attempts were made to slow down the rate of burning by the addition of "phlegmatizing" substances, such as glues, waxes, fats etc.

Partly successful results were obtained by Schultze [4] who prepared his powder by the following method. Wood cut into 1–2 mm grains was purified by boiling in sodium hydroxide solution and bleaching with calcium hypochlorite. It was then nitrated with a mixture of nitric and sulphuric acids. The nitration product was stabilized by boiling in a sodium carbonate solution, then dried and impregnated with a solution of either potassium or barium nitrate. After drying the grains were polished in a drum with paraffin wax to form a powder of the following composition:

50% nitrocellulose and nitrated hemicelluloses
13% non-nitrated wood pulp
33% potassium and barium nitrates
4% paraffin

This powder, however, was still too fast-burning for use in military rifles, but

was found suitable for use in shot guns, and was a forerunner of propellants of the "Schultze type" used in some countries (chiefly Great Britain) as sporting powders.

A few years later it was discovered that nitrocellulose dissolves in organic solvents, such as acetone, ethyl acetate and in mixtures of alcohol with ether, leaving on evaporation of the solvent a highly dense, transparent film, which burns more slowly than nitrocellulose itself (Hartig [5]).

Some investigators tried to make use of this property. Volkmann [6] improved Schultze's powder by dipping nitrated grains of wood into a mixture of ether and alcohol and then either mixing them with blackpowder to prevent caking and coating them with a layer of this explosive or compressing the sticky grains into larger cubes. In spite of the encouraging results obtained in using this powder (the size of charges required was half of that of blackpowder) the Austrian authorities stopped manufacture on the formal grounds that the plant concerned infringed their blackpowder monopoly.

A number of patents were then registered for various methods of using solvents to prepare granular powder from nitrocellulose (Spill [7], Reid [8], Wolf and Förster [9]). None of those methods, however, found practical application, except for a short time in the work of Duttenhofer at Rottweil [10]. Duttenhofer nitrated slightly carbonized cellulose, stabilized it and saturated the nitrocellulose so obtained with ethyl acetate until a gelatinized mass was formed. After being dried the horn-like mass was broken up in a corning mill and the grains so obtained were graded. Clearly, Duttenhofer employed virtually the same production method as that used to manufacture blackpowder.

Duttenhofer's powder was used for a certain time in Germany under the name of RCP (Rottweil Cellulose Pulver). Its greatest disadvantage was the irregularity of the shape of the grains which prevented it from burning as uniformly as the smokeless powder [11] invented by Vieille at about the same time.

Vieille developed his powder as the result of systematic investigations. In 1879 he began a study of the burning of explosives in a manometric bomb which he invented together with Sarrau.

In the course of studying the burning of blackpowder Vieille found that it can burn in parallel layers provided that its specific gravity is approximately 1.80 or more (p. 340). He extended his experiments (1882-1884) to nitrocellulose, and tested its behaviour at various densities. Since it turned out that high specific gravity nitrocellulose cannot be achieved simply by pressing, Vieille made use of the recognized method of increasing its specific gravity by treatment with various solvents. He formed the dough-like mass into flakes and thin sheets which on drying showed a fairly high specific gravity (about 1.65). By experiments in the manometric bomb, Vieille demonstrated that the flakes of the new powder burn in parallel layers and that this property makes their time of burning dependent upon their smallest dimension i.e. upon their thickness. Hence by altering this the total time of burning of the flakes may be controlled, and the "coefficient of the vivacity"

(coefficient de vivacité) of the powder

$$\left(\frac{dp}{dt}\right)_{\max}$$

where p is pressure produced by burning the powder, t is time of burning, may be determined in the manometric bomb. Thus powders of an adequate vivacity adjusted to a given calibre of arms may be easily standardized.

Shortly afterwards (1885) Vieille's powder was introduced in France under the name of B powder (Poudre B). Vieille utilized two types of nitrocellulose for its manufacture: collodion cotton CP₂ (Vol. II, p. 373), soluble in a mixture of ether and alcohol and forming the powder dough; cotton CP₁, insoluble in a mixture of ether and alcohol, incorporated into the powder mass in the form of unchanged fibres.

In Russia, Mendelejev [12] worked out a method for the manufacture of smokeless powder from pyrocellulose, i.e. relatively high-nitrated (12.5% N) nitrocellulose soluble in a mixture of ether and alcohol. In 1892 the manufacture of this powder was started for naval guns. Nitrocellulose powder of this type was soon adopted for military purposes in the U.S.A., where nitrocellulose powder became known as "single base powder".

A second type of smokeless powder, ballistite, was invented by Alfred Nobel [13] in 1888. He took advantage of the ability of nitroglycerine to dissolve nitrocellulose and thus replaced a volatile, non-explosive solvent (ether and alcohol in former powders) by a non-volatile explosive solvent—nitroglycerine. The ratio of nitrocellulose to nitroglycerine was 45:55. This is a relatively small amount of nitroglycerine which dissolves nitrocellulose with difficulty. Abel and Dewar [14] however succeeded in adapting acetone for the manufacture of nitroglycerine powder. This is a solvent of both the active ingredients: nitrocellulose and nitroglycerine. The product—British Cordite—has not been used outside the British Commonwealth. The powders made of nitrocellulose, nitroglycerine and a mixture of ether and alcohol as a solvent achieved only temporary success. The use of any solvent was troublesome and proved a drawback in manufacture, so that nitroglycerine powder without a volatile solvent, derived from ballistite, aroused much greater interest.

Work on the improvement of nitroglycerine powder without a volatile solvent was aimed at the reduction of its content of nitroglycerine. By the selection of a suitable nitrocellulose and by the addition of non-volatile solvents ("gelatinizing agents"), of the so-called "centralite" type ("carbamite" according to English nomenclature) as in Claessen's [15] patents, a new type of nitroglycerine powder, the so-called RP-12 or RPC-12, was manufactured from 1912 onwards (p. 652). This powder was used extensively during World War I since it could be produced much more quickly than nitrocellulose powder. The manufacture of this powder contributed largely to the long resistance of the Central Powers in World War I.

The enormous consumption of smokeless powder during this war led to difficulties in producing a sufficient quantity of nitroglycerine. In Russia and Germany attempts were made to replace part of the nitroglycerine by aromatic nitro compounds

such as DNT or "liquid TNT" (an oily mixture of DNT and TNT with isomers of TNT). This powder had several advantages. In comparison with nitroglycerine nitro compounds give a powder with a lower temperature of explosion that produces less erosion and flash. Powders containing nitro compounds with nitroglycerine were later adopted in the U.S.S.R.

Attempts to replace nitroglycerine partly or wholly by nitroglycol had little success due to the high vapour pressure of the latter which facilitates volatilization and, consequently, reduces its ballistic stability (ballistic properties change as nitroglycol volatilizes). Later, diethylene glycol dinitrate was tried (nitrodiglycol, DGDN) and was shown to have great advantages over nitroglycerine. With nitroglycerine, good gelatinization of the nitrocellulose may be obtained if the ratio of nitroglycerine to nitrocellulose is not less than 60:40, whereas with nitrodiglycol this ratio may be much lower, viz. 20-45 nitrodiglycol to 80-55 nitrocellulose, since nitrodiglycol is a better solvent of nitrocellulose than nitroglycerine. This facilitates manufacture and, at the same time produces a more uniformly gelatinized mass. Various alterations may also be introduced in the composition of powder such as an increase in the content of nitrocellulose or on addition of insoluble ingredients, serving, for instance, to suppress flash.

Solventless powder without nitroglycerine (G powder, p. 660) has a lower heat of explosion, and consequently causes less wear on the bore.

Gallwitz [16] reports the following data on the influence of the heat of explosion upon the bore wear. With a nitroglycerine powder containing no solvent and giving a heat of explosion of 950 kcal, the barrel stands up to 1700 rounds while with a similar powder giving a heat of explosion of 820 kcal, it withstands 3500 rounds. The reduction of the calorific value of the powder by 130 kcal therefore doubles the useful life of the barrel.

Further reduction of the calorific value of nitroglycerine powder proved to be impossible. But by using nitrodiglycol instead of nitroglycerine, a powder was obtained with a heat of explosion of 690 kcal, which prolonged the life of the barrel considerably, i.e. to 15,000-17,000 rounds.

Nitroglycerine or nitrodiglycol powder was known in the U.S.A. as "double base powder".

A further development led to the invention of flashless powder. Tests carried out in various countries, included the addition of aromatic nitro compounds to nitrocellulose powders and of potassium salts to nitroglycerine powders. Nitrodiglycol powder with an addition of 2% K_2SO_4 produced a small flash. During World War II in Germany and Great Britain it was the custom to add a considerable amount of nitroguanidine to nitrodiglycol powders. In Germany this was called "gudol" powder (German Gudol Pulver).

Other attempts to improve nitrodiglycol powders were based on the introduction of substances such as penthrite (German Nipolit Pulver) and cyclonite. In both cases a powder with a high calorific value was obtained. The manufacture of these powders never went beyond the pilot plant scale.

PROPERTIES OF SMOKELESS POWDER

PHYSICAL PROPERTIES

The specific gravity of semicolloidal nitrocellulose powder with a mixture of ether and alcohol as a solvent usually ranges from 1.54–1.63, although the specific gravity of nitrocellulose itself is 1.66. This indicates a certain porosity of the powder. The pores are filled either with air or with traces of residual solvent. According to Brunswig [17] 100 g of nitrocellulose rifle flake powder contains 4–8 cm³ of the air.

Nitroglycerine powder—completely or almost completely wholly colloidal—is less porous, therefore more difficult to ignite than nitrocellulose powder and requires a stronger priming.

The gravimetric density* of a powder depends upon the dimensions and shape of the grains. A suitably high gravimetric density may be obtained by polishing the grains and coating them with graphite. Its value determines the extent to which a cartridge case or powder chamber can be filled with powder. Generally, to make the most of the capacity of a cartridge case or powder chamber the gravimetric density should be as high as possible. E.g. by raising the value for smokeless powder from 0.770 to 0.830, the charge for a rifle was increased from 2.65 to 3.2 g and this led to an increase in muzzle velocity and range.

Occasionally it may happen that the gravimetric density of a powder is too high, in which case a considerably part of the chamber space or cartridge case remains empty. Then ignition may prove unreliable and burning not quite uniform. According to Brunswig [17], for instance, powder with a gravimetric density of 0.850 gave 0.07% misfires and 1.2% hangfires per 22,000 rounds, while a powder with a gravimetric density of 0.820 showed no such disadvantage.

Nitrocellulose powders (semicolloidal) are moderately hygroscopic; in an atmosphere saturated with water vapour they attain 2.0–2.5% moisture content. Nitroglycerine powders (colloidal) are virtually non-hygroscopic. (The hygroscopicity of nitrocellulose was discussed in fuller detail in Vol. II, p. 283.) This is accounted for by the fact that the nitrocellulose in the latter powders has a colloidal form of low hygroscopicity. By using such gelatinizing agents as DNT instead of nitroglycerine, the hygroscopicity of nitrocellulose powders was reduced. In the U.S.A. these powders were known under the name of NH-Powder (non-hygroscopic powder).

EXPLOSIVE PROPERTIES

Products of decomposition

The products of decomposition of smokeless powder resemble those formed by the decomposition of its ingredients, i.e. nitrocellulose or nitrocellulose with either nitroglycerine or dinitrodiglycol.

* Gravimetric density = the weight of the charge in a unit volume (e.g. kg in litre).

In nitrocellulose powder the chief products of explosive decomposition are inflammable gases: CO, H₂ and CO₂, H₂O, N₂. In nitroglycerine powder the average composition of the gases is similar, but owing to the more advantageous oxygen balance the amounts of complete combustion products (CO₂ and H₂O) are higher. In the products of the decomposition of smokeless powder methane is also found in small amounts and sometimes also hydrogen cyanide or carbon.

The composition of the decomposition products of powder varies, depending on many factors, the most important of which is the pressure in the powder chamber and in the bore of the gun. The pressure, in turn, depends mainly upon the density of loading. Thus, for instance, the decomposition products obtained from the same powder vary according to the density of loading (Table 161): the amount of CO₂ and CH₄ increasing, and that of CO and H₂ decreasing as density increases.

TABLE 161

AMOUNTS OF DECOMPOSITION PRODUCTS OF POWDER IN RELATION
TO DENSITY OF LOADING

Δ	Pressure kg/cm ²	CO ₂	CO	CH ₄	H ₂	N ₂	H ₂ O
0.1	730	9.6	44.8	0.7	20.7	10.3	13.9
0.3	3200	16.4	38.4	5.5	13.2	13.3	13.2

This may be deduced from the following equation, which takes place with reduction in volume:

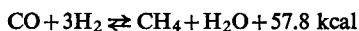

The reaction is exothermic, hence as the gases cool the reaction equilibrium is shifted to the right.

The decomposition products of a given powder differ at various distances from the muzzle since temperature and pressure decrease considerably with the movement of the projectile along the bore. Brunswig [17] reported the following figures for the German M/88 rifle (Table 162).

TABLE 162

Travel of the base of the projectile mm	Temperature of gases °C	Pressure kg/cm ²
200	1426	1385
300	1202	834
400	1060	577
500	965	434
600	877	339
693 (muzzle)	818	280

In addition to the above reaction the following dissociation reactions also take place:

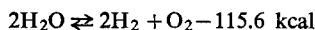
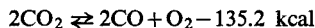

Here rise in temperature favours the displacement of the equilibrium to the right, whereas increase of pressure displaces the equilibrium to the left.

Poppenberg and Stephan [18] showed that pressure affects the system more strongly than temperature, so that the content of CO_2 grows and that of CO falls as the projectile moves towards the muzzle. The ratio $\text{CO}_2:\text{CO}$ at different positions along the bore varies as shown in Table 163.

TABLE 163

Travel of the projectile cm	18	28	50	70
$\frac{\text{CO}_2}{\text{CO}}$	0.298	0.324	0.362	0.393

Among the reactions which proceed inside the bore, the following is noteworthy:

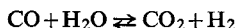

The reaction is exothermic and the equilibrium is displaced to the left as the temperature rises (Table 164).

TABLE 164

Temperature °C	$K = \frac{[\text{CO}][\text{H}_2\text{O}]}{[\text{CO}_2][\text{H}_2]}$
1600	4.24
1405	3.48
1086	2.04
886	1.19
686	0.52

The nitrogen present in the form of nitrate groups in the ingredients of the powder is almost completely transformed into molecular nitrogen N_2 in the final products of the reaction. A small amount of nitrogen, however, may remain in a form of nitrogen oxides, especially if the powder is burnt at a low pressure. Sometimes muzzle gases contain ammonia which is easy to detect by smell. Ammonia is formed by the reaction



which proceeds while there is still considerable pressure as the gases cool. This reaction is promoted by the presence of iron particles in the propellant gases.

Diagrams (Fig. 184) show the effect of the density of loading of nitroglycerine and nitrocellulose powder upon the amount of CO_2 , CO , H_2 and CH_4 evolved (according to Andrew Noble [19]) in the explosion products.

Nitroglycerine powder—cordite—gives a better proportion of more completely oxidized products.

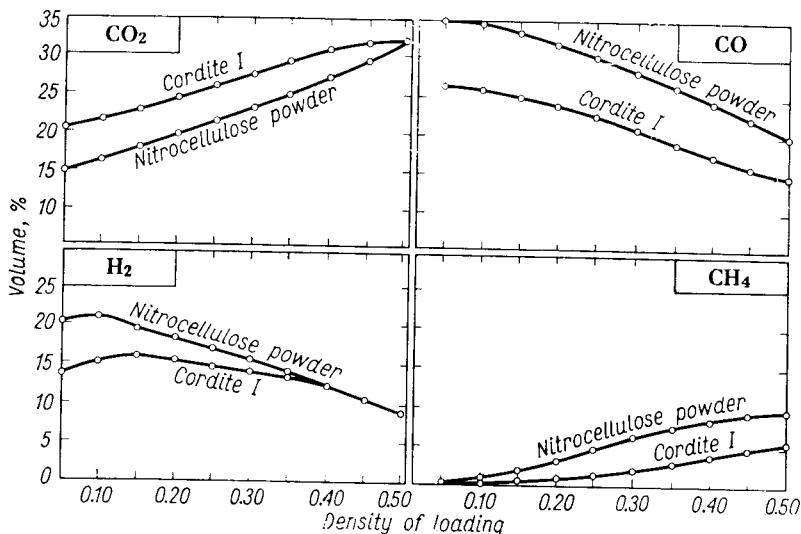

FIG. 184. Proportion of CO_2 , CO , H_2 and CH_4 in products of explosion of cordite and nitrocellulose powder as a function of density, according to Brunswig [17].

Gases may escape from the barrel through the breech end after the breech block has been opened. They may be toxic to the gun detachment if the breech end is situated in a confined space (naval gun turret, concrete pillbox, tank etc.). A flow of air to remove them is therefore essential. Similar hazards arise due to backflash.

Knight and Walton [20] examined the products produced by burning powder in a confined space, simulating a naval gun turret. Ten seconds after the ignition of 32 kg of powder, the estimated composition of the gases in the test container (about 25 m³ in capacity) was:

NO	1%
NO ₂	7%
CO ₂	17%
CO	28%
H ₂	8%
CH ₄	2%
N ₂	37%

After 20 sec the powder had burnt completely and fresh air was introduced into the container. The hot combustion products exploded again on being mixed with air. The estimated composition of the products after the second explosion

was:

NO ₂	1%
CO ₂	8%
CO	9%
O ₂	12%
N ₂	67%

Due to the presence of NO₂ and CO the gaseous products were very toxic to experimental animals.

Heat of explosion, volume of gases and temperature of the explosion products

The heat of explosion depends chiefly on the composition of the powder, e.g. in nitrocellulose powder on the content of nitrogen in the nitrocellulose and in nitroglycerine powder on the content of the nitroglycerine.

The effect of the composition of the powder, in particular of the content of nitroglycerine upon the volume of gases, heat and temperature of explosion is illustrated by the figures in Table 165 (according to Brunswig) and by the curves in Fig. 185 (on the basis of another series of experiments by the same author).

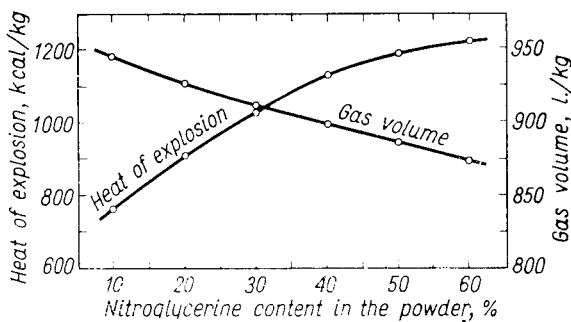

FIG. 185. Gas volume and heat of explosion of nitroglycerine powder as a function of the proportion of nitroglycerine in the powder [17].

TABLE 165

Composition of powder	1	2	3	4	5	6
Nitroglycerine	30	36	40	47	58	—
Nitrocellulose	65	52	50	53	37	100
Other non-explosive ingredients (centralite, vaseline etc.)	5	12	10	—	5	—
Volume of gases, V_0 (l./kg)	913	910	900	810	875	934
Heat of explosion (kcal/kg)	1030	935	1005	1090	1250	924
Temperature, t (°C)	2470	—	—	2850	2825	2230

Generally speaking, nitroglycerine powders give a higher heat of explosion, so that the temperature of their products is higher than that in nitrocellulose powders.

This means that nitroglycerine powders are more erosive (greater bore wear) (p. 548) and more flashy (p. 544).

Non-explosive substance (e.g. vaseline) are added to nitroglycerine powders to reduce the heat of explosion and the temperature of the flash. The addition of "cool" explosives such as nitroguanidine has the same effect.

The phenomenon of burning smokeless powder has been the subject of many investigations. Usually they are described in text-books on ballistics [21]. Here only a few essentials will be dealt with.

According to the Soviet authors Belayev and Zeldovich [22] the burning of colloidal or semicolloidal powder consists of the following stages:

- (1) decomposition of the solid and formation of gases,
- (2) reaction between the gases leading to a considerable increase of the temperature. The temperature of the solid surface remains relatively low.

This theory is diagrammatically represented by Fig. 186, according to Zeldovich [21]. The thickness is denoted by X .

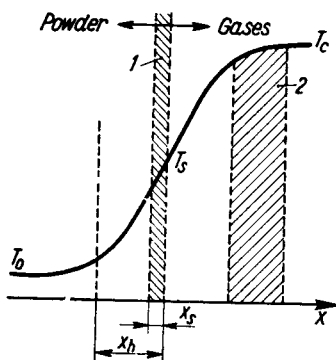

FIG. 186. Temperature distribution in a powder grain of thickness X , according to Zeldovich [21]; T_0 —temperature inside the grain, T_s —temperature on the surface, T_c —temperature of the combustion flame.

The chemical reactions of gas formation occur in zone (1) of X_p thickness; reaction between the gases occurs in zone (2). The temperature inside the powder is T_0 , in zones (1) and (2) is T_s and T_c respectively.

Inside the powder grain a superheated layer exists of thickness X_h . Here decomposition starts in the part denoted X_s .

The thickness of X_s is very small and forms only about 5% of the total thickness X_h . Heat is transmitted by conductivity, convection and radiation. The rate of burning of smokeless powders is determined by the rate of transmission of the energy from the products of combustion to the powder itself.

It is generally accepted that colloidal and semicolloidal powder burns in parallel layers. In fact this should be considered as an approximation as the burning surface is uneven and covered with pits products by the "hotter" spots.

Rideal and A. J. B. Robertson [23] suggest that initiation of the thermal explosion of nitrocellulose is preceded by liquefaction. Very likely the same would apply to nitrocellulose powder.

Huffington [24] studied the combustion of solventless cordite containing 56% nitrocellulose (12.2% N), 29% nitroglycerine, 4.5% carbamite and 10.5% dinitrotoluene plus 2.45% cryolite and 0.35% volatile matter.

He concluded that the burning of cordite is essentially an intermittent phenomenon in which periods of quiescence are followed by abnormally rapid burning. Under certain circumstances, there is a tendency towards the end of a rapid burning stage for the more stable components of the cordite (such as dinitrotoluene) to remain undecomposed or only partially decomposed relative to the other components.

These experiments appear to throw a new light on the structure of solventless cordite. It seems that nitroglycerine is present as minute globules and that the second type of intermittent burning is due to the non-thermal explosion of these globules.

A simple exponential equation proposed by Vieille [11] is very often used to denote the rate of burning (v) of colloidal and semicolloidal powders (i.e. powders burning approximately in parallel layers);

$$v = kp^n,$$

where k is a constant, p pressure, n an exponent.

For semicolloidal powder Vieille found $n=0.67$. Zabudskii [21] later established $n=0.93$.

Since smokeless powder burns by parallel layers the shape of the powder grains can have a decisive influence on the mode of burning: neutral (with an approximately constant burning surface), progressive (increasing surface), degressive (decreasing surface) (Fig. 187).

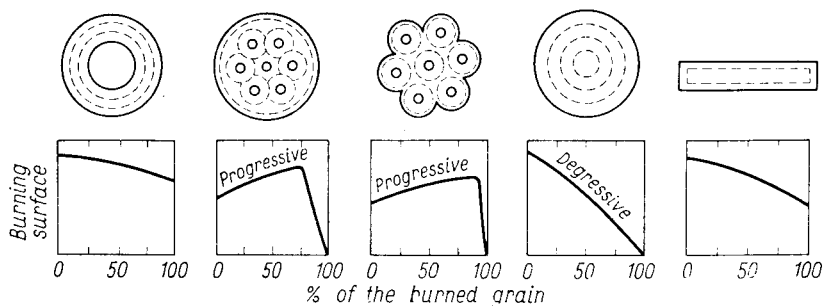

FIG. 187. Modes of burning of perforated grains and cords. The dotted lines represent approximately the positions of the inward and outward burning, according to [25].

The neutral and progressive types are most valuable.

Klein, Menster, Elbe and Lewis [26] recorded the flame temperature of burning smokeless powder using thermocouples and found in the vicinity of the burning surface layer about 0.6 mm in thickness in which there was a sudden jump in tem-

perature to 1200°C at pressures 25–50 kg/cm². They calculated from the figures obtained that the temperature of the surface of the powder immediately before burning was 250°C.

The temperature of the explosion products of smokeless powder (flame temperature) is dependent on the density of loading, increasing as the density increases. This is illustrated by the diagram in Fig. 188. A particularly notable rise of tempera-

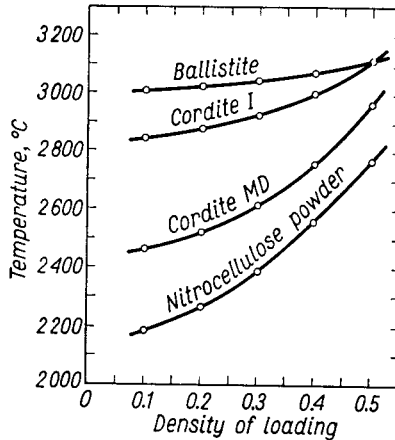

FIG. 188. Temperature of the explosion flame of powders as a function of density, according to Brunswig [17].

ture with density of loading is observed in nitrocellulose powders or those nitroglycerine powders which are poor in nitroglycerine and hence in oxygen.

A knowledge of the heat of explosion of smokeless powder is of considerable practical importance since the muzzle velocity of the projectile depends largely on this factor. For this reason the heat of explosion of manufactured powder must be checked from time to time. If the heat of explosion of a given lot of powder deviates from the specified value, then the necessary size of charge should be calculated to match the standard muzzle velocity. For this the empirical formula

$$CQ = K$$

is used, where C denotes the charge of powder, Q — the heat of explosion of 1 kg of powder, K — a constant quantity for a given projectile and a given muzzle velocity, irrespective of the type of powder.

Thus, for instance a charge of 4.3 kg of powder with a heat of explosion equal to 820 kcal/kg gives the same muzzle velocity as a charge of 6.0 kg of powder with a heat of explosion equal to 590 kcal/kg.

J. Taylor [27] drew up the following table of the heat of explosive decomposition, the gas volume and rate of burning of British nitroglycerine (double base) and American nitrocellulose (single base) powders (Table 166).

TABLE 166

Nitrocellulose powders (U.S.A.)	Heat of explosive decomposition (water liquid) kcal/kg	Gas volume (water vapour) l./kg	Linear coefficient for rate of burn- ing from one sur- face in./sec/in ²
Pyro Cannon Powder	875	955	0.40
NH Cannon Powder	765	978	0.38
FNH Cannon Powder	740	1005	0.355
Nitroglycerine powders (Great Britain)			
Cordite MD	1025	940	0.595
Cordite WM	1013	934	0.575
Cordite SC	970	957	0.50
Cordite NQ	880	1001	0.375
Cordite N	765	1058	0.315

In the German Army nitroglycerine powders (double base powders) possessed the following calorific values: 1250, 1150, 950 and 820 kcal/kg.

The diglycoldinitrate powders were characterized by calorific values: 930, 740, 690 kcal/kg (according to Gallwitz [16]).

Sensitiveness to impact and friction

Smokeless powders have low sensitiveness to impact and friction. They do not ignite when hit by rifle bullets and are thus fairly safe to handle in war-time. Nevertheless there have been accidents caused by the sudden ignition of nitrocellulose powder brought about by the violent friction between the sharp edge of a heavy bin and powder scattered on the floor.

Nitrocellulose powders is particularly sensitive to friction when hot. Accidents have been caused by the ignition of hot powder on removal from the drier, in all probability due to friction. Here electrification of the powder on drying also plays an important part (see below, pp. 542, 616) giving rise to the possibility of an electric discharge while it is being taken out. This had led to the regulation that the powder must not be taken out of the drier before it has been cooled.

Nitrocellulose powder is more sensitive to friction than nitroglycerine powder, although the latter is more sensitive to impact (due to the presence of nitroglycerine).

Sensitiveness to detonation

According to Kast [28] nitrocellulose powder does not detonate even when very strongly initiated (e.g. 50 g of picric acid or 100 g of tetryl), but may explode with a rate from 1000 to 1800 m/sec.

Conversely, T. Urbański and Galas [29] found that smokeless powder detonates with a rate from 3800 to 7000 m/sec when initiated by 20 g of picric acid, the rate

of detonation depending either on the density of loading or, in wide strip powders, on whether the detonation wave travels perpendicularly or in parallel with the surface of the strips. The figures compiled in Table 167 are characteristic of the phenomenon observed (the powder was placed in iron pipes 26/33 mm dia., and 20 g of picric acid was used for initiation).

TABLE 167

Type of powder	Way of loading	Density	Rate of detonation m/sec
<i>Nitrocellulose powder</i>			
Rifle flake non-polished powder	loosely poured	0.79	3800
Rifle flake polished powder	loosely poured	0.93	5300
Cannon strip powder French type BC, 0.55 mm thick	circles laid perpendicularly to the tube axis	1.45	7010
<i>Nitroglycerine powder</i>			
Ballistite, 1.3 mm thick	circles laid perpendicularly to the tube axis	1.53	7445-7615
Ballistite, 3 mm thick	circles laid perpendicularly to the tube axis	1.52	7720-7125

If powder strips or tubes are laid along the axis of the bore the powder is much more difficult to detonate. A stronger initiator is required and not infrequently explosion occurs with a rate of about 1500 m/sec, instead of a detonation. The figures listed in Table 168 refer to the same conditions of initiation (20 g of picric acid) in a pipe 26/33 mm.

Médard [30] also described experiments which were carried out in France by Vieille as early as 1906, Dautriche (1913), Burlot (1920-26) and by himself in 1938. Dautriche found that nitrocellulose powder BM 17 D2 in bands of thickness *ca.* 44 mm detonated at the rate of 6560-7200 m/sec when initiated by 50 g of picric acid.

Burlot found similar figures. He also examined the effect of the impact of a falling weight or of a rifle bullet. Only deflagration occurred — there was no detonation. However in his later experiments Burlot [31] has found that nitrocellulose powder (poudre BM9—in strips) can detonate under the shock produced by a rifle bullet "D" (caliber 8 mm, 7.5 g) having a velocity above 1200 m/sec (e.g. 1266 m/sec).

Ignitability

The ignition temperature of nitroglycerine smokeless powder is approximately 180°C and that of nitrocellulose powder about 200°C. Ignition with a direct flame,

especially of nitroglycerine powder, is rather difficult. In practice an indirect priming of blackpowder is used, the latter being ignited with a priming cap.

It has long been known that smokeless powder is readily electrified and that an electric discharge may cause its ignition. When dried it is particularly readily electrified by the frictions produced by the current of warm, dry air. The powder is also subject to very strong electrification when polished due to friction of the grains against each other and against the wooden balls.

TABLE 168

Type of powder	Way of loading	Density	Rate of detonation m/sec
<i>Nitrocellulose powder</i> BC strip powder 0.55 mm thick	strips laid along the bore	0.95	1495-1150 (explosion)
<i>Nitroglycerine powder</i> Ballistite 1.3 mm thick	strips laid along the bore	1.23	no detonation
Ballistite 3 mm thick	strips laid along the bore	1.24	2250-1965

According to Nash's [32] studies, nitrocellulose EC powder is electrified under the effect of an air current at a temperature of 65°C. The drier the powder, the more it is electrified. The dependence of voltage on the moisture content of the powder

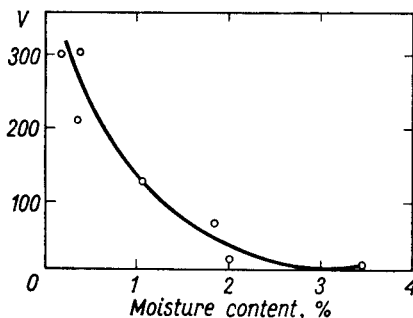

FIG. 189. Electric (static) charge of nitrocellulose powder as a function of moisture content, according to Nash [32].

is shown in the diagram (Fig. 189). As can be seen, powder with a moisture of over 1% cannot easily be electrified. Dry EC powder can be electrified up to 300 V. Colloidal powder is electrified even more strongly. E.g. pyrocellulose powder gelatinized with a mixture of alcohol and ether, when heated to 50°C, can be charged up to 3200 V under the influence of a warm air current. After being cooled to 15°C

and subjected to a cold air stream the voltage falls in 5 min to 2200 V, and after 20 min to 900 V, after which the latter voltage remains constant. Powder electrified to 2300 V maintains a charge of this voltage for a long time if not subjected to a cold air stream.

Nash proved experimentally that a discharge of accumulated electricity may cause EC powder to ignite if the voltage reaches 20,000 V. On this basis he came to the conclusion that EC powder cannot take fire in the drier under the influence of electric discharges since for its ignition a charge of higher potential is needed than that to which it can be charged on drying. Nevertheless the many accidents which have occurred by the ignition of hot powder when taken out of the drier appear to have been caused by the discharges of static electricity (sensitization of the powder to friction due to heating may also be possible here, as mentioned above, p. 540).

A number of explosions of smokeless powder during polishing are also attributable to electrification and subsequent discharge of electricity. In practice the careful earthing of the drums used for polishing is a sufficient safeguard. A danger can also be produced if the solvent (particularly ether) is charged with static electricity and then discharged with sparking. This is dealt with later on p. 589.

Langevin and Biquard [33] showed that the evaporation of a liquid (alcohol, ether, benzene) does not electrify the residual solvent. Hence evaporation of the solvent in driers cannot lead to electrification of the powder. In the opinion of these authors nitrocellulose powder may be ignited by the discharge of the condenser at a voltage of 3000 V, if the condenser charge is greater than 0.3 μ F.

According to the work of Brown, Kusler and Gibson [34] dry nitrocellulose can be ignited by a discharge of 0.062 J energy, nitrocellulose smokeless powder may be ignited by a discharge of 4.7 J energy whereas graphitized powder is much more difficult to ignite, requiring an energy of over 12.5 J. English authors (Morris [35]) believe these figures should be considerably lower: 0.3–0.6 J.

The French Comité Scientifique des Poudres [36] collected statistical data indicating that 75% of the accidents involving ignition occurred with completely dried powder; of these 41% were caused by the electrification of the powder by friction, and 34% by other, undefined reasons (e.g. insufficient chemical stability of powder). The remaining 25% of all accidents involving ignition were caused by the fact that the powder contained a considerable amount of solvent. Of these cases, 19.5% arose from electrification of the powder itself by friction, and 5.5% by electrification of the solvent. Generally speaking, electrification proved to be the source of 60% of the accidents in which the powder ignited.

MECHANICAL PROPERTIES

Mechanical properties of double base powders mainly for large rockets will be discussed later (pp. 675 and 678).

FLASH AND METHODS FOR SUPPRESSING IT

The discharge of a gun is almost always accompanied by a glaring flash which at night discloses its position. Experiments, particularly using cine-films, give the following picture of how flashes arise.

The "primary flame" in the form of a dark-red taper is created by inflammable gases escaping from the bore. These gases mix with the air to form an inflammable mixture. If the temperature of the mixture is sufficiently high, it ignites at the end furthest from the muzzle (Fig. 190).

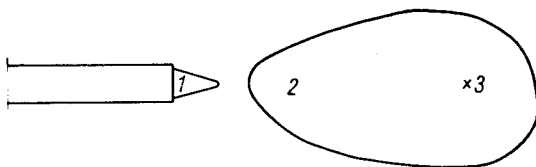

FIG. 190. Muzzle flame: 1—primary flame, 2—secondary flame, 3—initiation of the secondary flame.

The burning of the mixture may end with an explosion (detonation) if its composition is suitable. The explosion of the gas mixture is accompanied by a bright flame. This "secondary flame" is elliptical and visible for a great distance. The dimensions of the flame and the intensity of the flash depend to a great extent on the calibre of the gun; e.g. a shot from a 30 cm naval gun gives a secondary flame up to 50 m long, visible for a distance of 50 km.

The following circumstances favour the formation of a secondary flame:

- (1) The presence of gases that form inflammable mixtures in the gaseous products formed by the explosion of the charge (in the muzzle gases).
- (2) High temperature of the muzzle gases.

On the other hand the presence among the products of explosion of substances that prevent the explosion of the gas mixtures reduces the possibility of the secondary flame.

The most important inflammable components are hydrogen, carbon monoxide and methane, which form explosive mixtures with air. Gas composition has been discussed earlier in this chapter (p. 532).

According to Roszkowski [37] the explosive limits for these gases with air are:

Hydrogen	9.2–68.5%
Carbon monoxide	13.0–77.6%
Methane	5.5–13.2%

Methane has the narrowest limits so that a shot in which a large amount of this gas is generated is unlikely to produce a secondary flame. A high pressure in the bore favours the formation of a large proportion of methane (p. 533), hence a high charge density reduces the probability of the secondary flame.

Another factor in reducing the likelihood of a secondary flame is an increase in the concentration of non-flammable gases (CO_2 and N_2) in the products formed

by explosive decomposition of the powder. Since the nitrogen content in these products is limited by the nitrogen content of the powder, the only factor that can be varied to any extent is the content of carbon dioxide. High pressure and low temperature promote reactions for the formation of CO_2 (p. 534). Coward and Hartwell [38] claim that the explosive limits of a methane-air mixture are narrowed by adding CO_2 or N_2 (Fig. 191). Methane-air mixtures containing about 50% CO_2 are non-explosive.

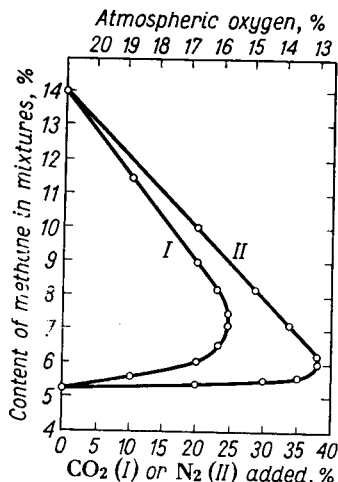

FIG. 191. Change of limits of explosibility of methane-air mixtures under the influence of added CO_2 (curve I) and N_2 (curve II) according to Coward and Hartwell [38].

The presence of water vapour in a methane-air mixture may exert the same effect as the presence of CO_2 , but small amounts of water vapour increase the possibility that the gas mixture will explode. This accounts for the observation that the secondary flame develops much more easily when the firing takes place in a moist atmosphere.

Another component favouring explosion in gas mixtures is nitrogen dioxide which may occur in small amounts as a result of incomplete decomposition of the powder.

The temperature of the propellant gases depends on the heat of explosion and on the gas composition. The greater the heat of explosion, and hence the temperature of gases, the more readily the secondary flame arises. Powders of a low calorific value may therefore give no secondary flame if the temperature of the gas mixture is lower than the temperature of ignition.

The ignition temperatures of the most important gaseous components of the explosion products (H_2 , CO and CH_4) in methane-air mixtures lie within the following limits:

Hydrogen	390–620°C
Carbon monoxide	610–725°C
Methane	730–790°C

This shows clearly the advantage of shifting the equilibrium towards the formation of a larger proportion of methane.

From a large number of practical data, it has been deduced that a powder will be flashless if on decomposition the heat emitted is below a certain limiting value. The heat effect of the explosion depends on the type of ordnance, i.e. on the calibre and length of the barrel, ranging from 800 kcal/kg for big guns to 1000 kcal/kg for smaller ones. "Flashlessness" can therefore be achieved either by adding active (explosive) components that lower the heat of explosion, (e.g. nitroguanidine, DNT) or inert (non-explosive) ones such as vaseline, centralite etc., to the propellant.

Substances inhibiting the development of the secondary flame are those which inhibit burning reactions. The strongest of the substances known to possess this property is the potassium ion. Its ability to prevent the development of a secondary flame was demonstrated by Dautriche [39] as early as 1908. Since then potassium nitrate has been employed in the manufacture of flash-reducing charges added to the charges of ordinary propellant.

Fauveau and Le Paire [40] proved that the addition of substances such as chlorides of alkali metals and alkaline earths to the charge reduces their tendency to develop a secondary flame; here the result is achieved by inhibiting the reaction of explosion, not by reducing the temperature of the gases. This is proved by the fact that salts of alkaline earths (e.g. CaCl_2) and of metals which have a high heat of evaporation and a considerable heat of decomposition at a high temperature, do not prevent the formation of secondary flame. Conversely, a typical inhibitor of gas explosions is potassium chloride which has neither a high heat of evaporation nor dissociates at temperatures reached within the barrel.

TABLE 169
EFFECT OF KCl ON THE IGNITION TEMPERATURE OF MIXTURES
OF CO WITH AIR

Content of KCl in mg per litre in the gas mixture	Ignition temperature ($^{\circ}\text{C}$) of the mixture with air containing		
	24.8% CO	44.1% CO	67.3% CO
0	656	657	680
0.4	—	750	800
0.5	730	—	820
0.7	—	810	900
1.0	790	850	1020
1.3	810	—	—
2.0	890	950	—
2.5	—	1000	—
3.0	970	—	—
3.5	1010	—	—

Prettre [41] found that potassium chloride sprayed in a mixture of carbon monoxide and air considerably raises the ignition temperature of these mixtures (Table

169), but it does not affect the ignition temperature of mixtures of hydrogen with air.

It has been shown that potassium chloride lengthens the induction period (the interval between the time the heating of gas mixture begins and the moment of explosion). Pease [42] found that in a vessel with walls coated internally with potassium chloride, the reaction of hydrogen with oxygen undergoes considerable inhibition, the induction period being lengthened one thousand times. The action of potassium ions is now explained by their capacity to initiate the combination of free H and O atoms and OH radicals into inert molecules, thus breaking chain reactions.

Free atoms of hydrogen and oxygen and OH radicals arise as a result of the following chain reactions:

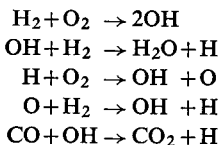

Examination of the flame spectrum of a mixture of hydrogen and oxygen does indeed point to the fact that hydrogen atoms and hydroxyl radicals take part in this reaction. The presence of OH radicals as intermediate products of the reaction between hydrogen and oxygen was demonstrated by an examination of the absorption spectrum of a mixture of these gases heated to a high temperature (over 1000°C) and by an examination of the absorption spectrum of water vapour at a temperature of 1500°C and higher (Bonhoeffer and Reichardt [43]; Avramenko and Kondratyev [44, 45]; Dwyer and Oldenberg [46]). Examination of the course of gaseous explosive reactions by kinetic absorption spectroscopy, invented by Norrish and Porter [47] is particularly noteworthy. By this method Norrish *et al.* [47–49] established the presence of the OH radical as an intermediate product in the reaction of hydrogen with oxygen, in the burning of hydrocarbons in an atmosphere of oxygen and in the other reactions in which water is one of the final products. Potassium ions promote the following chain-breaking reactions:

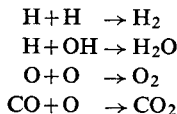

Investigations showed that the salts of other alkali metals are not so efficient in suppressing secondary flame as potassium salts. Fairly numerous experiments were carried out to clear up whether or not known antiknock substances, such as tetraethyl lead or nickel carbonyl prevent the development of a secondary flame. They proved to have no effect on its development. In practice, two methods for removing gun-flash may be employed, i.e. either a special flashless powder is produced, containing nitroguanidine or DNT and a small admixture of potassium sulphate,

or special flash-reducing charges containing potassium salts are added to the charges of smokeless powder. Potassium salts are often mixed with a weakly explosive substance (e.g. DNT) to facilitate the dispersion of potassium salt in the mixture of gases. The majority of the methods for removing flash, however, lead to an increase in smoke. The best results, in this respect, are obtained by the addition of nitroguanidine to the propellant. This either does not increase the smoke at all, or increases it only to an insignificant extent (smoke formation will be discussed later).

The combustible ingredients in the products formed when a propellant charge explodes give rise to backflash. This may arise when the breech-block of the gun is opened due to the air-current which is then created in the barrel. This air-current may be intensified by wind blowing in the direction opposite to the direction of fire. Then ignition of the hot gases mixed with air often results from the smouldering residue in the barrel (smouldering remainder of the cartridge bag, glowing soot). Sometimes the gases do not stop burning after a shot and continue to burn after the opening of the breech-block. Backflash creates a great danger for the gun crew since it may cause the ignition of the charges of powder prepared for subsequent shots or introduced into the barrel.

As with secondary flame, the addition of potassium salts to the powder prevents the development of backflash. In modern guns of heavy calibre the development of backflash is prevented by blowing either air, or a stream of water through the barrel, immediately after each shot.

SMOKE FORMATION

Nitrocellulose and nitroglycerine powders should properly be called "slightly smoky"; the name "smokeless" is inexact. The smoke from nitrocellulose and nitroglycerine powders is composed chiefly of water vapour. Shots from small arms or cannons of small calibre are slightly smoky or almost smokeless. Conversely guns of heavy calibre often give a considerable amount of smoke. The presence of metal torn off from inside the barrel and from the driving band in the products of combustion of the propellant is a partial cause of smoke.

It has been observed that the majority of remedies for preventing the development of flash lead to an increase of smoke (e.g. potassium salts give white smoke, aromatic nitro compounds give black-grey smoke due to the presence of unburnt carbon). Nitroguanidine is the only additive that does not appreciably increase smokiness. The burning of blackpowder in the primer produces an insignificant amount of smoke.

EROSIVENESS OF SMOKELESS POWDER

Every powder produces erosion or bore wear to some extent. After a large number of shots the wear may be considerable, especially in large guns, and this reduces their accuracy. The erosiveness of a given powder depends, first of all, on its flame

temperature. Nitroglycerine powders cause particularly severe erosion due to their high heat of explosion; they have a higher flame temperature than nitrocellulose powders. Attempts to reduce the heat of explosion of nitroglycerine powder by the addition of explosively inert substances (vaseline, centralite) or active substances of a lower heat of explosion (DNT) were primarily intended to decrease erosion.

Vieille [11] conducted extensive experiments on erosion in a manometric bomb, closed except for a small orifice, about 1.3 mm dia. in a metal plug (Fig. 192). Hot gases escaping through the orifice, eroded it to an extent determined by weighing the plug before and after each experiment: the loss of weight was taken as a measure

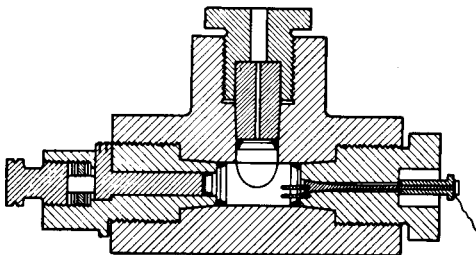

FIG. 192. Erosion bomb of Vieille [11].

of the erosiveness of the powder. Vieille showed that pressure lower than 1000 kg/cm² had little effect on erosion. Erosion increased with pressure over the range from 1000 to 2000 kg/cm² after which a further increase of pressure from 2000 to 4000 kg/cm² had no effect.

The erosion of metals varied depending largely on the melting point. For various metals erosion expressed in mm³ of metal removed from the orifice per 1 g of powder was:

Platinum	59 mm ³
Platinum-iridium	74 mm ³
Brass	326 mm ³
Zinc	1018 mm ³

Vieille considered that erosion is caused by fusion of the metal and subsequent expulsion of the molten substance. The results of Vieille's experiments are summarized in Table 170. The weak erosive action of nitroguanidine, attributable to its low temperature of explosion, is noteworthy.

Apart from physical agents such as temperature and the mechanical action of gases, chemical agents also cause the erosion. Monni [50] noticed that the erosiveness of smokeless powder decreases with the addition of charcoal, probably because the additional quantity of carbon thus introduced serves to carbonize the steel which may undergo decarbonization under the influence of CO₂ at a high temperature, according to the reaction:

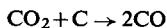

TABLE 170
EROSIVENESS OF VARIOUS POWDERS ACCORDING TO VIEILLE [11]

Type of powder	Charge	Pressure kg/cm ²	Calculated temperature °C	Erosion mm ³ /g
Nitrocellulose powders				
Pistol T	3.55	2500	2675	7.4
Rifle BF	3.55	2200	2675	6.4
Nitroglycerine powders				
Ballistite 50% NG	3.55	2360-2540	3385	24.3
Cordite 38% NG	3.55	2500	—	18.1
Blackpowder				
Sporting (78% KNO ₃)	8.88	1960	3530	4.5
Rifle (75% KNO ₃)	10.00	2165	2910	2.2
Various explosives				
Blasting gelatine (94% nitroglycerine)	3.35	2460	3545	31.4
Nitroguanidine	3.90	2020	970	2.3

The decarbonization of steel increases the porosity of the metal. The adsorption of gases in the pores may intensify the erosive action; since the gases enter the pores at high pressures and temperatures and then expand, they "blow up" the pores.

The following factors reduce erosion:

- (1) Low maximum pressure;
- (2) Low temperature of explosion;
- (3) Uniform ignition of powder, uniform burning and complete combustion;
- (4) The largest possible content of H₂ and the smallest possible content of CO₂ and CO in the explosion products.

To minimize erosion it is desirable to use powders which give a heat of explosion of about 700 kcal/kg and a temperature of about 2100°C. The effect of the heat of explosion on the lifetime of the barrel has been dealt with earlier (p. 531).

STABILITY OF SMOKELESS POWDER

Soon after the manufacture of nitrocellulose smokeless powder began it was established that the powder obtained by the partial dissolution of nitrocellulose in a mixture of alcohol and ether (partly colloidal powder) has a chemical stability inferior to that of the nitrocellulose from which it derived. Thus Vieille [11] reports that on heating to a temperature of 110°C CP₁ guncotton undergoes denitration with the evolution of 0.04 cm³ NO/hr/gramme whereas the powder obtained from these substances without a stabilizer undergoes denitration at more than twice the rate, namely 0.10-0.15 cm³ NO/hr/gramme of substance.

Originally, the cause of this phenomenon was unknown. In all the countries producing smokeless powder methods for improving the stability of the powder were sought. Similar research was also initiated by Vieille but in spite of systematic

experiments he arrived at the wrong answer. Vieille examined powders which had been stored for a long time and in which it was assumed that decomposition had started. He noticed that these powders contained less residual solvent than fresh powders, i.e. freshly manufactured powders contained approximately 1% of residual solvent (mainly less volatile ethyl alcohol) whereas the old powders contained considerably less than 1%. He therefore concluded that the stability of powder is lowered by the loss of residual solvent and its stability may be improved by adding a less volatile substance, chemically similar to the solvent. Indeed an improvement in stability was achieved (1896) by adding 2% amyl alcohol (the proportion being referred to the dry weight of the nitrocellulose). Ten years later, however (1906) it was noticed that these powders showed signs of decomposition, so the amount of alcohol added was increased to 8%. These powders were marked with the letters AM and a number indicating the content of amyl alcohol, thus AM 2, AM 8.

In 1905, on the Japanese battleship "Mikasa" some English nitroglycerine powder containing a certain amount of mercuric chloride, exploded. This substance interferes with the heat test (Vol. II, p. 23) and makes it impossible to detect the beginning of decomposition in the powder. (Mercuric chloride inhibits the darkening of the potassium iodide-starch test paper in the presence of N_2O_4 .) Next, in 1907, a disaster occurred which aroused public protest all over the world, especially in France. This was the explosion of the ammunition store on the French battleship "Jena". The investigation into the cause of this explosion was still in progress when, in 1911, another similar catastrophe occurred when some powder manufactured in 1906 containing 8% amyl alcohol blew up on the battleship "Liberté". It became plain that the decomposition of smokeless powder during storage was caused by some process other than the volatilization of residual solvent (Buisson [51]).

The accidents described above showed that nitrocellulose cannot be considered wholly safe even when carefully purified, if it is partly or wholly colloidal in form.

Subsequent investigations have shown that the stability of powder at temperatures higher than room temperature depends upon many factors. Thus, an examination of the effect of the web thickness of flakes or tubes upon the stability of powder at temperatures of 75–80°C showed that the larger the web thickness the higher the stability. This relationship is shown in Brunswig's [17] diagram (Fig. 193). Curve *I* shows losses in weight (in %) of the fine tubular powder (for a 3.7 cm cannon), curve *II* refers to a somewhat thicker powder (for a 7.5 cm gun), curve *III* refers to a thicker powder (for a 15 cm gun), curve *IV* refers to a very thick powder (for a 20 cm gun), curve *V* to the thickest powder of all (for a 30 cm gun). A loss of 25% weight occurred in the finest powder after 2½ months. In the thicker powders it occurred after about 4, 9, 10½ and 12½ months, respectively.

The lower stability of smokeless powder in comparison with that of nitrocellulose is accounted for by its content of residual solvent and of the oxidation products of this solvent. Since in a finer powder the ratio of the surface to weight is high, the oxidation processes are more intense. A larger amount of decomposition products of residual solvent is formed by oxidation, and their destructive effect

on nitric esters (nitrocellulose, nitroglycerine) in the powder is more severe.

The following findings point to the harmful effect of air on the stability of "green" nitrocellulose powder, i.e. freshly pressed and containing a considerable quantity of solvent (alcohol and ether) (Table 171).

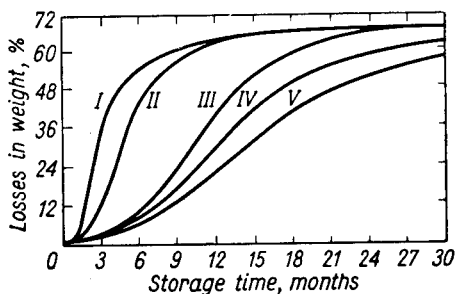

FIG. 193. Stability of tubular nitrocellulose powder at 75–80°C as a function of the web thickness of the tubes, according to Brunswig [17].

TABLE 171

THE EFFECT OF AIR ON THE STABILITY OF NITROCELLULOSE POWDER

Method of drying the powder	Stability, min	
	at a temperature of 110°C (for reddening of litmus paper)	at a temperature of 135°C (for appearance of first brown fumes)
Dried in the air	285	50
5 days in absence of air	570	110
7.5 days in absence of air	825	180
10 days in absence of air, then in the open	1020	190

When the powder is freed from most of the solvent in absence of air, subsequent drying in the open is not detrimental, since the amount of solvent is too insignificant to form oxidation products in a quantity which might impair stability.

The experiments of Świątosławski, T. Urbański, Całus and Rosiński [52] showed that "green" flake powder containing about 15% solvent emits a certain amount of heat which is very small but which may be detected in Świątosławski's [53] micro-calorimeter. The heat effect fades after the green powder has been stored for a certain time in a sealed calorimetric vessel but reappears if oxygen is added, hence it may be assumed that this heat effect is caused by oxidation reactions between the residual and atmospheric oxygen. A powder containing very little solvent (soaked and dried) gives no such heat effect.

This means that the presence of a substance of very low volatility such as amyl alcohol may under certain circumstances prove detrimental to the powder's stability.

Indeed, it was found that amyl alcohol is converted into amyl nitrite and nitrate by the action of nitric oxides resulting from the decomposition of nitrocellulose. These substances are then oxidized to form valeric acid and amyl valerate products distinguishable by their characteristic smell.

There are many factors which affect the decomposition of powder during storage, the most important of which is temperature.

The decomposition of powder at an elevated temperature does not differ greatly from that of the nitric esters themselves, i.e. nitrocellulose and nitroglycerine (the decomposition of nitrocellulose at various temperatures was discussed earlier in Vol. II, p. 310). The higher the temperature, the more actively the decomposition of the powder proceeds, with total loss of nitrogen, as NO and NO₂, and carbon as CO and CO₂. Hydrogen is evolved chiefly as water, the amount of water decreasing with increase in the temperature of decomposition of the powder (Sapozhnikov's investigations).

The course of the decomposition reaction is different when the powder is stored at or just above room temperature. A marked oxidation then occurs. It is chiefly an internal oxidation with the ONO₂ groups acting as an oxidizer, but also involves atmospheric oxygen, and the residual solvent.

Powder for use in a tropical climate requires higher stability than that in a temperate climate. Powder for the navy must also have a high stability, since it may be transported into a tropical zone.

Atmospheric humidity has a deleterious effect on the stability of powder. Storm [54] reports that a good nitrocellulose powder, which withstood heating at a temperature of 65.5°C for 400 days without marked decomposition, showed evident decomposition in 175 days when stored at the same temperature in an atmosphere saturated with water vapour. Powder which passed the first test subsequently withstood heating for 5 hr at a temperature of 135°C without explosion, whereas powder from the second test exploded at the same temperature after 10 min.

The ease of decomposition by moisture is particularly pronounced in nitrocellulose powders, which are hygroscopic but is much less in those with a lower hygroscopicity i.e. in nitroglycerine powders. According to Brunswig [17] nitroglycerine tubular powder lost the same amount of weight at a temperature of 46°C in both a dry and a damp atmosphere, when stored for a period of 6 months. Nitroglycerine powder of the cordite type, containing vaseline, i.e. a moisture-proofing agent, is also noteworthy, its stability in a damp atmosphere being the same as that in a dry one. In Brunswig's opinion the addition of 3% vaseline to nitroglycerine powder protects it against the harmful effect of moisture. This powder when stored in a damp atmosphere, at a temperature of 46°C showed no loss of weight over 6 months, while common nitrocellulose powder, stored under the same conditions, for comparison, showed a loss of weight of 7.1%. The nitrocellulose powder with added vaseline is however unacceptable ballistically, so that proofing of this kind has no practical significance for nitrocellulose powders.

Nitric oxides exert a very detrimental effect upon the stability of powder, induc-

ing rapid denitration. Vieille [11] gives the following figures for nitrocellulose powder maintained at a temperature of 40°C, in an atmosphere containing nitrogen dioxide (Table 172).

TABLE 172
THE EFFECT OF NITRIC OXIDES ON THE STABILITY OF
NITROCELLULOSE POWDER

Duration of test, days	Powder without stabilizer	Powder with an addition of 7% amyl alcohol	Powder with an addition of 1% diphenylamine
	Nitrogen content of powder (%)		
0	12.10	12.40	12.50
7	11.05	11.0	11.20
13	10.68	9.85	9.60
21	9.18	9.40	9.41

On the basis of extensive investigations into the stability of powder de Bruin and de Pauw [55] proved that the gaseous products of the decomposition of smokeless powder, in particular nitric oxides and water, increase the rate of the decomposition of powder at a temperature of 110°C. This is confirmed by the fact that when absorbents that take up the gaseous products are introduced into the test room, the duration of the test is extended. Figure 194 shows a number of curves for the stability of nitrocellulose powder at a temperature of 110°C in the presence of various substances absorbing the gaseous products of decomposition. The sample of powder tested without an absorbent decomposed most rapidly (curve *VIII*). The substances which inhibit the decomposition of powder most efficiently are: phosphoric anhydride (combining with water) (curve *I*), calcium oxide (combining with water and NO₂) (curve *II*), carbamate (centralite) (combining with NO₂) (curve *III*), activated carbon (absorbing water and NO₂) (curve *IV*). Sodium carbonate (combining with water and NO₂ but evolving CO₂) (curve *V*), vaseline, absorbing nitric oxides (curve *VI*) and anhydrous cupric sulphate combining with water (curve *VII*) were less efficient. Thus, when the decomposition of powder involved the isolation of nitric oxides its denitration occurred rapidly both in powders with and without a stabilizer.

Other acid substances, e.g. hydrogen chloride or vapours of sulphuric acid, affect the powder in a similar deleterious way.

If a powder which decomposes and forms acid products is mixed with a "healthy" powder it causes the latter to decompose. The products of decomposition of smokeless powder were found to contain formic acid, hydroxypyruvic acid CH₂OH·CO·COOH, hydroxyisobutyric acid (CH₃)₂C(OH)COOH and oxalic acid. All these acids except oxalic acid are hygroscopic, hence by increasing the moisture content in the powder, they hasten its decomposition. Acid products react with alkaline stabilizing components.

Brunswig [17] describes the following experiment. 30 g of flake powder was poured into a flat glass vessel. In the middle of this charge was placed a piece of

tubular powder in a state of decomposition, containing acid products. The vessel was covered with a watchglass and put into an atmosphere saturated with water vapour. In a few days the tubular powder had changed into a greasy substance. In a few weeks the flake powder gradually underwent a similar transformation with pronounced decomposition progressing from the tubular powder in concentric rings. The flake powder became soft so that it could be rubbed through the fingers.

It is a practice in some countries to add a small amount of sodium hydrogen carbonate to the powder dough, to neutralize dinitrogen tetroxide evolved during the decomposition of the powder. This would lead to formation of sodium nitrate

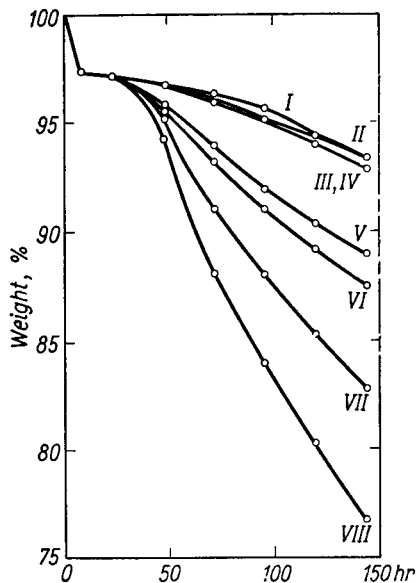

FIG. 194. Stability of nitrocellulose powder at 110°C (measured as a reduction of weight) in presence of substances absorbing gaseous products of decomposition (H_2O , NO_2).

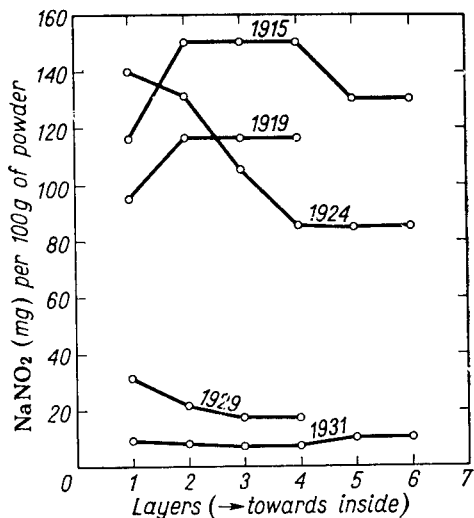

FIG. 195. Quantity of sodium nitrite in various layers of Italian powder (Polvere C) at various times of manufacture [57].

and nitrite. Angeli and Jolles [56] established a colorimetric method for determining the quantity of sodium nitrite in powder (by extracting it with water, diazotizing aniline and coupling with dimethylaniline). They suggested it as a method for estimating the degree of decomposition of the powder. The quantity of nitrites (calculated as nitrous acid) varied from 0 to 145 mg in 100 g of the powder.

Jolles and Socci [57] also examined the distribution of sodium nitrite in various layers of an Italian tubular double base powder (Polvere C). According to their estimation the distribution of sodium nitrite along the tubes is practically the same whether on the surface or in an internal layer. The distribution varies from the surface to the inside of the tube. In "young" powders the quantity of nitrite on the surface is higher than inside. With time this may be reversed and in "old" powders the internal layers may be richer in nitrite. This is shown in the diagram (Fig. 195)

which gives the results of an examination of "young" (e.g. 1931) and "old" (e.g. 1915) powders.

Decomposing powder which on heating emits visible nitric oxides ($N_2O_4 \rightleftharpoons 2NO_2$) also emits a small amount of heat at room temperature. This was ascertained (Świętoślowski, T. Urbański, Catus and Rosiński [52]) in Świętoślowski's microcalorimeter. Immediately before this stage of decomposition, however, powder which has not yet started to emit nitric oxides abundantly shows no positive heat effect at room temperature.

These results do not conform to those of the "silvered vessel test". This test determines the time necessary to produce pronounced exothermic reaction in a sample of powder heated to a temperature of 80°C. This reaction causes a rise of temperature by 2°C above the ambient temperature. The relatively high temperature (80°C) may account for the different results. It may well be that the exothermic reaction recorded here is a reaction between the acid products of the decomposition of the powder and the basic ingredients of the glass of the vessel at the relatively high temperature.

A good powder should withstand this test for at least 500 hr. Immediately before the rise of temperature up to 82°C, or just after this rise, nitric and nitrous acids are evolved from the powder. Sometimes, shortly after a temperature of 82°C has been achieved, explosion follows.

On heating nitroglycerine powder of a ballistite type to a temperature of 95°C in a Dewar vessel without a stabilizer, de Bruin [58] obtained the following data on temperature rise:

after a lapse of 48 hr	95°C
after a lapse of 72 hr	95.2°C
after a lapse of 96 hr	95.2°C
after a lapse of 108 hr	96.4°C
after a lapse of 119 hr	97.9°C
after a lapse of 120 hr	98.6°C
after a lapse of 120½ hr	102.6°C
after a lapse of 120¾ hr	explosion

When the powder used for this test was mixed with Centralite II, the temperature first rose to 97.2°C during 26 days of heating (an increment by 2.2°C) followed by a gradual drop.

Strong bases have an adverse effect on the stability of smokeless powder as described above. Moreover, Angeli [59] found that pyridine and its homologues cause decomposition of nitrocellulose. (On the action of pyridine on other nitric esters see Vol. II.) At an elevated temperature (e.g. 110°C) pyridine can produce an intense denitration of esters which may even lead to an explosion.

After World War I the influence of sea water on the stability of smokeless powder was examined. It was found that nitrocellulose powder submerged in the sea during military activities did not suffer any perceptible deterioration as a result of immersion in sea water for several years, neither in its colloidal properties nor in its stability.

In all probability this may be partly accounted for by the low temperature of sea water at a certain depth.

Sunlight is a factor which hastens the decomposition of smokeless powder. Experiments carried out by D. Berthelot and Gaudechon [60] showed that powders containing various types of stabilizers behave in different ways towards light. E.g. powder stabilized with amyl alcohol proved to be more resistant to sunlight than that containing diphenylamine. The latter darkens very rapidly under the influence of light, which no doubt accelerates the decomposition of diphenylamine.

Whatever its behaviour in sunlight, powder should not be exposed to direct sunshine at any stage of manufacture; all the windows of the plant should face north and any that do not should be covered with a layer of blue or yellow varnish, to cut off the rays of shorter wavelength.

STABILITY TESTS

The majority of the stability tests for smokeless powder are much the same as the methods used to determine the stability of nitric esters, in particular nitrocellulose (Vol. II). They are based on heating samples of the powder, thus starting decomposition processes or hastening processes already initiated within the powder. The value of such methods is comparative, since at an elevated temperature different reactions occur than those which would arise under normal conditions of storage. Nevertheless experiments over many years have shown that certain interrelations may be established for the stability of powder at various temperatures. Vieille [61] reports that the heating of a sample of powder for 1 hr at a temperature of 110°C involves approximately the same decomposition as:

- 24 hr of heating at a temperature of 75°C
- 7 days of heating at a temperature of 60°C
- 30 days of heating at a temperature of 40°C

In addition to the testing methods common to nitric esters (nitrocellulose, nitroglycerine) and smokeless powder there are also methods used exclusively for testing the stability of smokeless powders.

One of the inspection methods employed in smokeless powder factories consists in taking samples (about 500 g) from each lot of powder and placing them in hermetically closed jars. The jars are kept in thermostatic premises where a temperature of 30–50°C is maintained. A methyl violet reagent-paper (a paper tinted with crystal violet and rosaniline) is placed in each jar above the surface of the powder. If oxides of nitrogen are evolved by the powder, the paper gradually loses colour. A change in the colour of paper is therefore a sign that particular attention should be paid to this lot of powder, which should be subjected to detailed testing. This method may also be used in powder magazines.

Another method of checking stability consists of placing the powder into boxes of special design connected with an exhaust valve and a tube that leads any gases

formed inside the box to a vessel containing a solution of potassium iodide and starch. Any traces of nitrogen dioxide given off by the powder are detected immediately since they produce a coloration of the solution.

In addition to the above methods which are designed to detect active decomposition periodical sampling and stability testing by one of the known methods is absolutely indispensable. The simplest of these methods are:

(1) The Abel heat test (heating at a temperature of 75–80°C in the presence of standard potassium iodide–starch paper).

(2) The stability test for nitrocellulose powder at a temperature of 134.5°C; the sample will not be considered serviceable unless the time necessary to produce the evolution of nitrogen oxides is at least 45 min and the powder withstands this temperature without exploding for 5 hr. The test can be combined with methyl violet test: decoloration of the test paper should not occur before 30 min or longer according to particular specifications.

(3) The test for nitroglycerine powders at a temperature of 120°C (nitroglycerine powders cannot withstand higher temperatures); here the same conditions apply as in the test for nitrocellulose powders, viz. appearance of the nitrogen oxides after a lapse of at least 45 min and no explosion for 5 hr. The same test can be carried out in the presence of methyl violet test papers. Decoloration of the paper should not occur before 30 min.

(4) The reduced heating test at a temperature of 110°C in the presence of a blue litmus paper, which should not redden in less than 10 hr.

(5) The Vieille test at a temperature of 110°C (Vieille [61]). For this a sample of powder is heated daily for 10 hr or until the litmus paper has assumed a standard red tint. The sample is then aerated for 14 hr and the procedure is repeated each day until the litmus paper reddens in one hour or less. The course of the test can be seen from a following example:

1st day	10 hr	} together the first reddening after 19 hr
2nd day	9 hr	
3rd day	7.5 hr	
4th day	7.5 hr	
nth day		} 1 hr (or less)
Together		} x hr

The value of x for good powders should not be less than 70 hr.

Quantitative tests are rarely conducted in magazines and for production inspection purposes except for a test devised by Bergmann and Junk [62] in which the quantity of acid products (calculated as NO) evolved by the powder is determined by titration. The quantity of NO evolved on heating for 2 hr at a temperature of 132°C should not exceed 2.5 cm³ NO per 1 g of powder. (For more details see Vol. II p. 26.) Other quantitative tests are usually employed in research.

According to Jolles *et al.* [56, 57] the colorimetric determination of the quantity of sodium nitrite in powder (p. 555) can be an auxiliary method of estimating the stability of powders. Results agree well with the results of the heat test.

Tonegutti and Debenedetti [63] found that this test also agrees well with the methyl violet test at 120°C.

Jolles and Socci [57] give the following figures confirming the findings of Tonegutti and Debenedetti (Table 173).

TABLE 173
COMPARISON OF SODIUM NITRITE CONTENT AND THE METHYL VIOLET TEST OF ITALIAN DOUBLE BASE POWDER (POLVERE C)

Sample	Date of manufacture	NaNO ₂ in mg %	Decoloration of methyl violet test paper at 120°C after min
1	1915	150.0	45
2	1919	116.0	50-55
3	1924	80.0	70-75
4	1929	16.0	100-105
5	1931	7.0	105-110

STABILIZATION OF SMOKELESS POWDER

STABILIZATION WITH DIPHENYLAMINE

An important advance in the stabilization of nitrocellulose powder was the addition of diphenylamine to the powder cake, suggested by Alfred Nobel in 1889 [64] and introduced into practice in Germany. According to Gorst [65] diphenylamine was also used in Russia at the end of the nineteenth century on the suggestion of Nikolskii. The application of diphenylamine to the powder in Germany was kept a profound secret, but as early as 1896 it was known in France that German nitrocellulose powder contained 2% diphenylamine. However it was believed in France that diphenylamine was too basic, and liable to hydrolyse nitrocellulose. Nevertheless, in view of the disaster on the battleship *Liberté*, the use of diphenylamine as a stabilizer for nitrocellulose powder was approved in 1911. Comparison of the stability of powders without stabilizer, with amyl alcohol and with diphenylamine gave *inter alia* the following results:

At a temperature of 75°C in a dry atmosphere, a powder with an admixture of 2% diphenylamine gave off only about one quarter the amount of gases evolved by a powder with an admixture of 8% amyl alcohol heated for the same period of time. At a temperature of 110°C the stability of the powder containing diphenylamine proved to be 2.5 times greater than that containing amyl alcohol.

A powder with an admixture of 1.5% diphenylamine, when heated at a temperature of 75°C in a dry atmosphere showed signs of decomposition only after 512 days, whereas powder containing 2% amyl alcohol began to decompose after 122 days. In a damp atmosphere at a temperature of 75°C a powder containing

2% diphenylamine decomposed much more slowly (at least four times more slowly) than the powder containing 8% amyl alcohol.

Berger [66] defined the degree of decomposition of powder at temperatures of 40–110°C, by determining the amounts of heat emitted by the fresh powder on burning and by partly decomposed powder. From this difference he calculated the amount of heat emitted on decomposition. Berger thus examined the behaviour of powder without a stabilizer (AT), powder with amyl alcohol (AM) and D powder with diphenylamine; he obtained curves (Fig. 196), the shapes of which are charac-

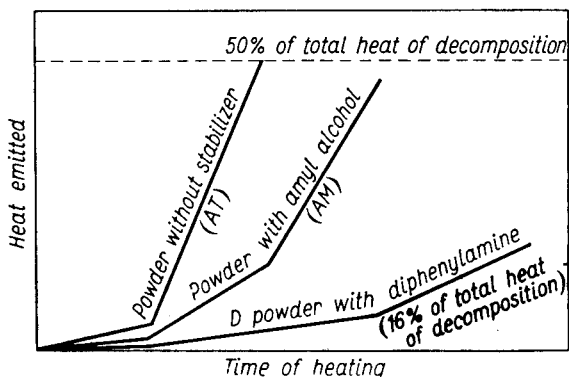

FIG. 196. Effect of the addition of amyl alcohol and diphenylamine on the stability of nitrocellulose powder, according to Berger [66].

teristic for the transition from slow to fast decomposition of powder. In the author's opinion violent decomposition coincides with the sharp inflection in the curve that occurs after an initial period characteristic of a resistance to decomposition that varies with the type of stabilizer added.

Investigations have shown that the basic properties of diphenylamine are so weak that it cannot hydrolyse nitrocellulose, but they are sufficiently strong to neutralize any acid product arising either from the decomposition of impurities in the nitrocellulose, from the oxidation of residual solvent or even from decomposition of the nitrocellulose itself. It was also demonstrated that the basic properties of diphenylamine may have a deleterious effect on the powder if the diphenylamine content exceeds 5%. The best stabilizing results are achieved by using 1.0–2.5% diphenylamine.

The results of extensive investigations into the influence of the content of diphenylamine and other stabilizers on the stability of powder are tabulated below.

More recently Demougin and Landon [67] examined the stability of nitrocellulose powder containing 1.02–7.8% diphenylamine at a temperature of 110°C. After 160 hr of heating they determined the nitrogen content in nitrocellulose isolated from powder (Table 174.). The initial content of diphenylamine in the sample was 7.8%; on heating for 180 hr at a temperature of 110°C it was reduced to 1%.

TABLE 174

THE INFLUENCE OF DIPHENYLAMINE CONTENT ON THE STABILITY OF NITROCELLULOSE POWDER

Time of heating at a temperature of 100°C	Content of diphenylamine			
	1.02	2.2	3.75	7.8
	Content of nitrogen in nitrocellulose, %			
0 hr (fresh powder)	12.82	12.89	12.76	12.58
160 hr	11.89	13.01	11.14	10.13

A large content of diphenylamine may be particularly detrimental to the ballistic properties in fine-grain (rifle) powders. That is why 0.5–1.0% diphenylamine is used in these powders whereas in slower burning cannon powders 1.5–2.0% is used.

Diphenylamine is not used for stabilizing powders containing nitroglycerine since it hydrolyses this ester. Diphenylamine also causes the decomposition of higher nitrated aromatic compounds and therefore should not be used in powders containing such compounds.

In wartime the content of diphenylamine was reduced to 0.5% and even to 0.25% in expectation of the rapid utilization of the powders. Such powders should be labelled, e.g. by the addition of red dye, so that after hostilities they can be re-checked and used up quickly or destroyed. After World War I the storage of such powders caused a number of catastrophes; e.g. in Poland there were explosions of the magazines in the Warsaw citadel (1924) and at Witkowice (1927) and in France at Bergerac (1928).

Diphenylamine behaves not only as a stabilizer, but also as an indicator of the oxidation and decomposition processes which occur in powders. It was noticed long ago that powders containing diphenylamine assume under certain conditions colours ranging from greenish or bluish shades to dark blue or almost black and sometimes to yellow or brown, i.e.:

(1) The powder turns dark blue if it contains a large quantity of solvent and if it is exposed to the action of hot air, e.g. on drying at a temperature of 50–60°C. The investigations of Desmaroux [68], Marquoyrol and Muraour [69] and of Marquoyrol and Loriette [70] showed that this is due to the oxidation of diphenylamine produced by peroxides formed from residual ether and atmospheric oxygen.

(2) The powder turns blue if it contains traces of metals or if it is in contact with such metals as iron, copper, zinc, etc. Traces of metals present in powder sometimes cause the formation of blue stains around the metallic particles. A blue coloration appears sometimes at the points where the powder is in contact with metal on the inner surface of cases lined with metal.

Dark coloration of the powder need not necessarily signify decomposition, but it proves that some of the diphenylamine has undergone changes and has been consumed to form new products. This might reduce the stability of the powder and, as a rule, it is no longer serviceable for military purposes.

With mineral acids, including nitric acid produced by the decomposition of powder, the N-nitroso compound undergoes rearrangement to form *p*-nitrosodiphenylamine (IV). This substance is readily oxidized to *p*-nitrodiphenylamine (V). Furthermore, the higher nitrated products, i.e. dinitro derivatives (VI) and (VII) and trinitro derivatives (VIII) may be formed in powder. Davis and Ashdown isolated 2,4,4'-trinitrodiphenylamine from American pyrocollodion powder by heating a sample in a closed vessel for 240 days at a temperature of 65°C. At the end of the heating period brown nitric oxides were given off by the powder.

It is generally agreed that powder in which diphenylamine is completely converted into N-nitrosodiphenylamine is suitable for storage. However, on the disappearance of N-nitrosodiphenylamine and its conversion into nitro compounds, the powder should be considered unsuitable for storage since it then lacks a stabilizer.

Powder in which nitro derivatives of diphenylamine have been formed is coloured reddish-yellow or brown.

According to Schroeder *et al.* [72] the chromatographic analysis on silica of the conversion products of diphenylamine in nitrocellulose powder indicates that diphenylamine may be converted into hexanitrodiphenylamine. From $\frac{1}{2}$ to $\frac{2}{3}$ of diphenylamine is converted into nitro derivatives if the powder is kept at a temperature of 71°C for 258 days.

Stabilizers which had or still have practical application are classified into inorganic and organic.

INORGANIC STABILIZERS

As early as 1867 Abel [73] realized that nitrocellulose tends to decompose in an acid medium, and suggested that sodium carbonate should be added to it to neutralize the acid products of the decomposition of the impurities in the powder or of nitrocellulose and nitroglycerine *per se*. However more than 2% sodium carbonate in the powder proved detrimental—due to its strongly alkaline reaction it impairs the stability of the powder.

Accordingly, attempts were made to use the less alkaline sodium hydrogen carbonate (NaHCO_3). It was shown that 1% of the latter has no marked effect, either positive or negative, on the stability of nitrocellulose powder, but with nitroglycerine powder containing vaseline, its influence is decidedly helpful. Brunswig [17] describes cases in which nitroglycerine powder with vaseline and NaHCO_3 withstood storage for 20 years without any signs of decomposition whereas the same powder without NaHCO_3 showed a pronounced decomposition, several times ending in self-ignition after a lapse of 5 years.

Calcium carbonate, often added to nitrocellulose at the end of stabilization, affects the stability of powder beneficially, its influence, however, becomes strongly marked only when used in large quantities. Brunswig reports that powder containing 0.1% of CaCO_3 withstands heating at a temperature of 94°C in a closed vessel for 4.5 hr; nitric oxides are then given off and after 20 hr its loss of weight amounts to 19.7%. If the same powder contains 6% of CaCO_3 the loss of weight on

heating at a temperature of 94°C for 200 hr does not exceed 0.4%. Nevertheless, it is inadvisable to introduce large amounts of a non-explosive substance to the powder mass lest its ballistic properties should be impaired. Magnesium carbonate acts similarly to calcium carbonate.

Magnesium oxide was added to the newest German nitroglycerine powders used during World War II. A content of 0.25% MgO considerably improved their stability and, in addition, facilitated pressing the powder paste. In all probability this is the most efficient inorganic stabilizer.

ORGANIC STABILIZERS

Apart from diphenylamine a number of other organic bases were tested for use as stabilizers. Some of them, e.g. aniline, were used only temporarily, chiefly during World War I when diphenylamine was in short supply. The basic properties of aniline are too marked and this is detrimental to stability. On the other hand, relatively good results have been obtained with carbazole which resembles diphenylamine in its structure:

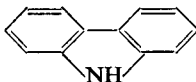

Marqueyrol [74] reported experiments carried out in France over a period of 15 years to compare the efficiency of various stabilizers. The results are shown in Table 175. In addition to amyl alcohol and diphenylamine, the action of N-nitrosodiphenylamine (diphenylnitrosamine), carbazole, diphenylbenzamide, nitronaphthalene and naphthalene was also tested. The powder was stored at temperatures of 40, 60 or 75°C. The experiments were stopped when the powder showed signs of intense decomposition, giving off nitric oxides. This was also manifested by a sudden fall of the nitrogen content in nitrocellulose isolated from the samples.

Non-volatile solvents ("gelatinizers") such as camphor and butyl phthalate have also a definite stabilizing effect on powder. This applies especially to those which contain nitrogen: urea substitution derivatives (centralites or carbamites, acardit) and urethane substitution derivatives (see p. 645). It was found that on decomposition of the powder the centralites are nitrated and their nitro derivatives are formed. Nitro groups are obviously introduced into aromatic rings. Lecorché and Jovinet [75] ascertained that the centralite (carbamite) in solventless nitroglycerine powder is converted into substances volatile and non-volatile with steam.

The volatile fraction consists chiefly of *p*-nitrophenylethyl nitrosamine (I) and the non-volatile fraction of dinitrocentralite (II):

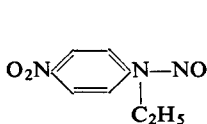

I

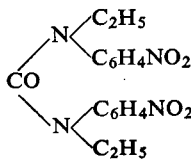

II

TABLE 175

THE EFFICIENCY OF VARIOUS ORGANIC STABILIZERS

Time (days) of storage at a temperature of 40°C	0	387	843	1174	2991	3945	4016
Stabilizer	Nitrogen content in the nitrocellulose, %						
No stabilizer	12.63	—	12.48	9.25	—	—	—
2% amyl alcohol	12.65	—	12.43	12.55	12.46	—	10.81
8% amyl alcohol	12.60	—	12.46	12.57	12.44	—	12.40
1% diphenylamine	12.60	—	12.48	12.58	12.57	—	12.58
2% diphenylamine	12.48	—	12.40	12.46	12.47	—	12.52
5% diphenylamine	12.52	12.59	—	—	—	12.36	—
10% diphenylamine	12.52	12.45	12.40	—	—	—	—
Time (days) of storage at a temperature of 60°C	0	146	295	347	1059	2267	3935
Stabilizer	Nitrogen content in the nitrocellulose, %						
No stabilizer	12.65	9.15	—	—	—	—	—
2% amyl alcohol	12.65	12.35	—	9.2	—	—	—
8% amyl alcohol	12.60	12.34	—	12.41	10.0	—	—
1% diphenylamine	12.60	12.36	—	12.51	—	—	—
2% diphenylamine	12.48	12.27	—	12.41	—	—	—
5% diphenylamine	12.52	—	12.26	—	—	—	11.62
10% diphenylamine	12.52	—	12.03	—	—	—	10.82
Time (days) of storage at a temperature of 75°C	0	86	231	312	516	652	667
Stabilizer	Nitrogen content in the nitrocellulose, %						
2% amyl alcohol	12.71	11.97	—	—	—	—	—
1% diphenylamine	12.60	12.26	—	12.39	11.94	—	—
2% diphenylamine	12.48	12.18	—	12.40	—	12.02	—
5% diphenylamine	12.52	—	12.06	—	—	—	11.65
10% diphenylamine	12.52	—	11.52	—	—	—	11.00
Time (days) of storage at a temperature of 75°C	0	55	146	312	419	493	—
Stabilizer	Nitrogen content in the nitrocellulose, %						
1% diphenylamine	12.54	12.38	12.41	12.46	12.36	12.40	12.14
2% diphenylamine	12.51	12.61	12.41	12.42	12.36	10.73	—
10% diphenylamine	12.61	12.22	12.15	12.07	11.93	11.72	11.53

TABLE 175 (CONTD.)

Time (days) of storage at a temperature of 75°C	0	60	85	108	197	377	633
Stabilizer	Nitrogen content in the nitrocellulose, %						
2% amyl alcohol	12.57	12.44	12.31	—	—	—	—
1.25% carbazole	12.55	12.47	—	12.46	11.44	—	—
10% carbazole	12.53	12.43	—	12.37	12.40	12.07	11.90
Time (days) of storage at a temperature of 75°C	0	31	50	62	87	227	556
Stabilizer	Nitrogen content in the nitrocellulose, %						
1.5% diphenylbenzamide	12.52	12.47	11.65	—	—	—	—
10% diphenylbenzamide	12.52	12.40	—	—	12.53	—	—
1.5% mononitronaphthalene	12.66	12.50	—	—	—	—	—
10% mononitronaphthalene	12.64	12.40	—	12.07	—	—	—
1.5% naphthalene	12.66	12.52	12.19	—	—	—	—
10% naphthalene	12.63	12.46	—	—	—	12.46	12.52

Such substances as vaseline (added to nitroglycerine powders of the cordite type), castor oil and rosin are also capable of stabilizing powder.

Brunswig [17] gives the following comparative figures based on the weight loss coefficient, i.e. the loss of the weight of powder in a unit of time $\frac{\Delta m}{\Delta t}$, as a criterion of stability. The values of the weight loss coefficient have been found for powder consisting of 10 parts of guncotton and 8 parts of nitroglycerine, obtained with the use of acetone as a solvent. They are summarized in Table 176.

TABLE 176

Type of stabilizer	Amount of stabilizer	$\frac{\Delta m}{\Delta t}$
No stabilizer	—	0.77–1.05
Vaseline	0.8 pt.	0.31
Rosin	0.8 pt.	0.30
Centralite	0.8 pt.	0.28

The systematic studies of T. Urbański, Kwiatkowski and Miładowski [76] proved that the addition of an aromatic nitro compound distinctly enhances the stability of nitrocellulose and nitrocellulose powder. Thus, nitrocellulose containing 13.4% N which on heating for 5 hr at 120°C had pH=2.28 showed pH=2.89 on addition of 9.1% *p*-nitrotoluene, pH=3.17 on addition of 9.1% 2,4-dinitrotoluene and pH=3.34 on addition of the same amount of α -trinitrotoluene. The same samples when heated in a constant volume (Tagliani test) gave at 134.5°C a pressure of decomposition

products of 109 mm Hg after 32.5 min with pure nitrocellulose, after 44.5 min with nitrocellulose and the addition of 9.1% *p*-nitrotoluene, after 48.5 min with nitrocellulose and the addition of 9.1% 2,4-dinitrotoluene and after 52.5 min with nitrocellulose and the addition of 9.1% α -trinitrotoluene. The same nitro compounds do not influence the stability of nitroglycerine.

The experiments summarized in Table 175 show the stabilizing action of nitronaphthalene. Dinitro- and trinitronaphthalene also act in a stabilizing manner. On the other hand mixed nitramines such as tetryl are detrimental to stability.

APPARENT STABILIZERS

There are substances which appear to stabilize a powder by masking the results of stability tests. One of them is mercuric chloride (corrosive sublimate). Sell [77] originally suggested the addition of sublimate to nitrocellulose to prevent the development of mould on moist nitrocellulose. A test of the purity and accuracy of the stabilization of nitrocellulose containing sublimate led to an unexpected result, i.e. even the worst stabilized nitrocellulose gave no coloration to the standard test paper in the Abel heat test. For a certain time sublimate was added to the powder mass in an amount of 0.02–0.03% and to powder earmarked for tropical countries in an amount of 0.05%. This greatly hindered research on genuine stabilizers. It was later shown that mercuric chloride is partly reduced under the influence of nitrocellulose and during the heat test mercury volatilizes (usually at 65–82°C) and combines on the test paper with iodide formed by nitric oxides, to form colourless mercuric iodide.

Experiments showed that minute amounts of mercury vapour in the atmosphere are sufficient to discolour a blue iodide–starch paper, e.g. on heating a mixture of 0.2 g of barium nitrate with 0.8 mg of mercury to a temperature of 80°C there is immediate discoloration of the paper.

LITERATURE

1. C. F. SCHÖNBEIN, *Sitzungsber. Naturforsch. Ges. Basel* 7, 27 (1846).
2. J. H. PELOUZE, *Compt. rend.* 23, 809, 837, 861, 892 (1846).
3. LENK VON WOLFSBURG, according to S. J. ROMOCKI, *Geschichte der Explosivstoffe*, Bd. II, Oppenheim, Berlin, 1896.
4. E. SCHULTZE, *Deutsche Industrie-Ztg.* 10, III, 1865; *Das neue chemische Schiesspulver*, Berlin, 1865.
5. HARTIG, *Untersuchungen über den Bestand und die Wirkungen der explosiven Baumwolle*, Braunschweig, 1874.
6. F. VOLKMANN, Austrian Pat. 21/208, 21/257 (1871); also according to O. GUTTMANN, *Zwanzig Jahre Fortschritte in Explosivstoffen*, Berlin, 1909; *Z. ges. Schiess- u. Sprengstoffw.* 4, 16 (1909).
7. D. SPILL, Brit. Pat. 1739 (1879).
8. W. F. REID, Brit. Pat. 619 (1882).
9. W. WOLF and F. FÖRSTER, Ger. Pat. 23808 (1883).

10. M. VON DUTTENHOFER, according to H. BRUNSWIG, *Das rauchlose Pulver*, de Gruyter, Berlin-Leipzig, 1926; Brit. Pat. 6022 (1887); 8776 (1902).
11. P. VIEILLE, *Mém. poudres* 3, 9, 177 (1890); 4, 256 (1891); 7, 19, 30 (1894); 11, 157 (1901); 15, 61 (1909-1910); *Z. ges. Schiess- u. Sprengstoffw.* 6, 181, 303, 327, 441, 464 (1911).
12. D. I. MENDELEYEV, *Sochineniya*, Vol. 9, Izd. Akad. Nauk SSSR, Leningrad-Moskva, 1949; *Morskoy Sbornik* 268, 38 (1895); 272, 39 (1896); *Bull. Soc. d'encour. Sci.* [4], 10, 1100 (1893); *Engineering* 63, 180 (1897).
13. A. NOBEL, Brit. Pat. 1471 (1888).
14. F. A. ABEL and DEWAR, Brit. Pat. 5614 (1889).
15. C. CLAESSEN, Ger. Pat. 256572 (1910-1913).
16. H. GALLWITZ, *Die Geschützladung*, Heereswaffenamt, 1944, according to Technical Report PB 925, U.S. Dept. of Commerce, Washington.
17. H. BRUNSWIG, *Das rauchlose Pulver*, de Gruyter, Berlin-Leipzig, 1926.
18. O. POPPENBERG and STEPHAN, *Z. ges. Schiess- u. Sprengstoffw.* 4, 281, 305, 388 (1909).
19. ANDREW NOBLE, *Proc. Roy. Soc. (London)* A 76, 381, 512 (1905); 78, 218 (1906).
20. H. C. KNIGHT and D. C. WALTON, *Ind. Eng. Chem.* 18, 287 (1926).
21. According to M. E. SEREBRYAKOV, *Vnutrennaya ballistika*, Oborongiz, Moskva, 1962.
22. A. F. BELAYEV and YA. B. ZELDOVICH, according to M. E. SEREBRYAKOV [21].
23. E. K. RIDEAL and A. J. B. ROBERTSON, *IIIrd Symposium on Combustion*, p. 536, Williams & Wilkins, Baltimore, 1949.
24. J. D. HUFFINGTON, *Nature* 165, 840 (1950); *Trans. Faraday Soc.* 47, 864 (1951).
25. D. R. CAMERON, in *Encyclopedia of Chemical Technology*, Ed. R. E. KIRK and D. F. OTHMER, Vol. 6, Interscience, New York, 1951.
26. R. KLEIN, M. MENSTER, H. v. ELBE and B. LEWIS, *J. Phys. Chem.* 54, 877 (1950).
27. J. TAYLOR, *Solid Propellants and Exothermic Compositions*, Newnes, London, 1959.
28. H. KAST, *Z. ges. Schiess- u. Sprengstoffw.* 15, 196 (1920).
29. T. URBAŃSKI and T. GALAS, *Wiad. Techn. Uzbr.* 34, 501 (1939); *Z. ges. Schiess- u. Sprengstoffw.* 34, 103 (1949).
30. L. MÉDARD, *Mém. artill. franç.* 18, 277 (1939).
31. E. BURLLOT, *Mém. artill. franç.* 23, 183 (1949).
32. H. NASH, *Army Ordnance* 11, 293 (1931); *Mém. artill. franç.* 12, 765 (1931).
33. A. LANGEVIN and P. BIQUARD, *Mém. poudres* 26, 255 (1934-1935).
34. F. W. BROWN, D. J. KUSLER and F. C. GIBSON, U.S. Bureau of Mines Report 3852 (1946).
35. F. MORRIS, *Engineering* 49, 73 (1947).
36. Comité Scientifique des Poudres.
37. J. ROSZKOWSKI, *Z. physik. Chem.* 7, 485 (1891).
38. H. F. COWARD and F. J. HARTWELL, *Safety in Mines Research Board, London* 19 (1926).
39. H. DAUTRICHE, *Compt. rend.* 146, 535 (1908).
40. J. FAUVEAU and LE PAIRE, *Mém. poudres* 25, 142 (1932-1933).
41. M. PRETTRE, *Mém. poudres* 25, 160, 169, 531 (1932-1933).
42. R. N. PEASE, *J. Am. Chem. Soc.* 52, 5106 (1930).
43. K. F. BONHOEFFER and H. REICHARDT, *Z. physik. Chem.* A139, 75 (1928).
44. L. J. AVRAMENKO and V. N. KONDRATYEV, *Zh. eksp. teor. fiz.* 7, 842 (1937).
45. V. N. KONDRATYEV, *Kinetika Khimicheskikh gazovykh reaktsii*, Izd. Akad. Nauk SSSR, Moskva, 1958.
46. J. DWYER and O. OLDENBERG, *J. Chem. Phys.* 12, 351 (1944).
47. R. G. W. NORRISH and G. PORTER, *Nature* 164, 658 (1949); *Proc. Roy. Soc. (London)* A210, 439 (1952).
48. R. G. W. NORRISH, G. PORTER and B. A. TRUSH, *Proc. Roy. Soc. (London)* A216, 165 (1953); A227, 423 (1955).

49. R. G. W. NORRISH, XVI Congrès de Chimie Pure et Appliqué, Paris, 1957, *Experientia Suppl.* VII, 87 (1957).
50. According to V. RECCI, *Z. ges. Schiess- u. Sprengstoffw.* 1, 285 (1906).
51. A. BUISSON, *Le problème des poudres*, Dunod & Pinat, Paris, 1913.
52. W. ŚWIĘTOSŁAWSKI, T. URBAŃSKI, H. CAŁUS and M. ROSIŃSKI, *Roczniki Chem.* 17, 444 (1937).
53. W. ŚWIĘTOSŁAWSKI and J. SALCEWICZ, *Roczniki Chem.* 14, 621 (1934).
54. C. STORM, *Army Ordnance* 9, 230 (1929).
55. G. DE BRUIN and P. F. M. DE PAUW, *N.V. Koninklijke Nederlandsche Springstofffabrieken* 3, 4 (1926); 6 (1927); 8 (1928); 9 (1929).
56. A. ANGELI and Z. E. JOLLES, *G. Chim. Ind. ed Appl.* 14, 65 (1932).
57. Z. E. JOLLES and M. SOCCI, *G. Chim. Ind. ed Appl.* 15, 113 (1933).
58. G. DE BRUIN, *N.V. Koninklijke Nederlandsche Springstofffabrieken* 5 (1927).
59. A. ANGELI, *Atti reale accad. Linzei, Roma* 23, 20 (1919).
60. D. BERTHELOT and GAUDECHON, *Compt. rend.* 153, 1220 (1911).
61. P. VIEILLE, *Mém. poudres* 5, 81 (1892).
62. E. BERGMANN and A. JUNK, *Z. angew. Chem.* 17, 1022 (1904).
63. M. TONEGUTTI and B. DEBENEDETTI, *Ann. Chim. Applicata* 22, 627 (1932).
64. A. NOBEL, Ger. Pat. 51471 (1889).
65. A. G. GORST, *Porokha i vzryvchatyye veshchestva*, Oborongiz, Moskva, 1949.
66. E. BERGER, *Bull. soc. chim. France* [4], 11, 1 (1912).
67. P. DEMOUGIN and M. LANDON, *Mém. poudres* 26, 273 (1934-1935).
68. J. DESMAROUX, *Mém. poudres* 21, 238 (1924).
69. M. MARQUEYROL and H. MURAOUR, *ibid.* 21, 259 (1924).
70. M. MARQUEYROL and P. LORIETTE, *Mém. poudres* 21, 277 (1924).
71. T. L. DAVIS and ASHDOWN, *Ind. Eng. Chem.* 7, 674 (1915).
72. W. A. SCHROEDER, E. W. MALMBERG, L. L. FONG, K. N. TRUEBLOOD, J. D. LANDERL and E. HOERGER, *Ind. Eng. Chem.* 41, 2818 (1949).
73. F. A. ABEL, *Trans. Roy. Soc.* 157, 181 (1867).
74. M. MARQUEROL, *Mém. poudres* 23, 158 (1928).
75. H. LECORCHÉ and P. L. JOVINET, *Mém. poudres* 23, 147 (1928); *Compt. rend.* 187, 1147 (1928).
76. T. URBAŃSKI, B. KWIATKOWSKI and W. MIŁADOWSKI, *Przemysł Chem.* 19, 22 (1935); *Z. ges. Schiess- u. Sprengstoffw.* 32, 1 (1937).
77. E. SELL, *Arbeiten Kaiserl. Gesundh. Amt* (1888).

CHAPTER VIII

THE MANUFACTURE OF SMOKELESS POWDER

INTRODUCTION

THE present chapter does not deal comprehensively with all the existing methods of powder manufacture. The manufacturing processes for smokeless powders described below should be regarded only as typical of some of the methods which were or still are used but which are often liable to very considerable variation. It should be borne in mind that some of the more recent methods are kept secret. The author has accentuated, as far as possible, the differences existing between the methods adopted in various countries.

Nitrocellulose powders can be classified into semicolloidal powders made of two kinds of nitrocellulose (insoluble and soluble in the solvent—ether and alcohol), almost fully colloidal, made of pyrocollodion cotton (highly soluble in ether-alcohol) and Schultze type powders with a very low content of colloidal nitrocellulose and containing inorganic salts. The Schultze nitrocellulose powders are now of little significance and very little used, so they will be discussed only briefly.

Nitrocellulose powders completely gelatinized with such solvents as acetone, ethyl acetate etc. were also known and manufactured for some time in various countries. They were of passing interest only because they possessed a number of disadvantages: the high cost of the solvents, the difficulty of igniting the powder and a number of difficulties in the course of manufacture produced by the high viscosity of the dough and its ready adhesion to metallic surface which made extrusion or rolling difficult.

Ball-grain powder is an example of a modern powder approaching fully colloidal structure through the use of ethyl acetate.

Another type of nitrocellulose powder used for some time which eventually disappeared from the market was a semi-colloidal nitrocellulose powder containing inorganic salts such as potassium or barium nitrate (e.g. Poudre T in France, with 2% potassium nitrate) or with dichromates (e.g. Poudre J in France with 14% ammonium dichromate and 3% potassium dichromate). The dichromate powder was very sensitive to friction and its dust contained toxic dichromates.

Nitroglycerine powders can be classified into two groups: with and without a volatile solvent. Semi-colloidal nitrocellulose powders and nitroglycerine solventless powders are the most important types of smokeless powder.

NITROCELLULOSE POWDER

NOMENCLATURE

The semi-colloidal powders are designated in every country according to the purpose for which they are intended. In the U.S.S.R. (Gorst [1]) rifle powders were formerly given the letter B (Russian V from the word "vintovka" i.e. rifle) followed by another letter denoting the type of projectile to be used, thus BA (Russian VL) for powder for light projectiles, BT (Russian VT), for powder for heavy projectiles.

Tubular and multiperforated powders for field artillery are, in addition, designated by a fraction, in which the numerator shows the web thickness in tenths of millimetres, and the denominator the number of perforations. The letters TP (Russian TR) following these figures mean that the powder in question is a tubular one. Thus $\frac{10}{1}$ TP denotes a single-perforated tubular powder with a web thickness of 1 mm. Similarly $\frac{9}{7}$ TP denotes a multiperforated tabular powder (7 perforations) with a web thickness of 0.9 mm.

Naval and coastal artillery powders are also designated by fractions, but for these the numerator signifies the calibre of the gun in millimetres, while the denominator shows the length of bore in calibres. Thus 75/50 signifies a powder for 75 mm guns, 50 calibres long.

The number of the lot of the powder, and the date and place of manufacture are given at the end, e.g. 2/49Φ is a powder forming part of the 2nd lot of 1949 produced at Φ (Russian F).

In Anglo-Saxon countries nitrocellulose powders are known as single base powders, i.e. made of only one explosive component.

In France nitrocellulose flake (strip) powder is shown by the letter B followed by further letters indicating its purpose. E.g. BF denotes rifle powder (fusil), BnF—newer (nouveau) rifle powder, BFP—progressive rifle powder, BC—powder for field (campagne) guns, BSP—powder for siege howitzers (siège et place) used mainly in 75 mm field guns. Recently, powders for the larger military guns were given letters BGC (gros calibre) with a subscript showing the calibre, e.g. BGC₄, BGC₅ etc. or simply BG₄, BG₅ etc. Powders for naval ordnance have the letters BM (marine) also with a subscript denoting the calibre:

Powders	Calibres
BM ₅ to BM ₇	100 and 138.6 mm
BM ₅ to BM ₉	164.7 mm
BM ₉ to BM ₁₀	194 mm
BM ₇ to BM ₁₃	240 and 274.4 mm
BM ₁₃ to BM ₁₇	305 mm
BM ₁₃ to BM ₁₉	340 mm

Other letters and subscripts show the stabilizer used and its amount, thus BM_7AM_8 means a powder BM_7 stabilized with an addition of 8% amyl alcohol. $BSP\ D1.5$ is a powder for siege howitzers stabilized with an addition of 1.5% diphenylamine. BM_5 powder is thin since it is extruded through a die of about 2.3 mm, and BM_{17} powder through a die of about 7.5 mm.

In Germany, the following nomenclature of nitrocellulose powder was in use:

SP—flake powder for rifle;

Gesch. Bl. P. (Geschütz Blättchenpulver)—flake powder for 8.8 cm guns;

Gr. Bl. P. 03 (Grobes Blättchenpulver)—large flake powder for 15 cm and 21 cm guns;

RG 96

RP 05) tubular powders for 96 n/a (127 mm long);

RP 97 and 99 (Röhrenpulver)—tubular powders for 10 cm guns;

RP 07—tubular powder for 13 cm guns;

Man RP (Manöver-Ringpulver)—blank ring powder for field guns.

According to Gallwitz [2] more recent German coding used during World War II also indicated dimensions, composition etc. The dimensions of the dies used for the extrusion of tubular or strip powder were given in millimeters. They differ from the actual grain dimensions. All powders containing volatile solvents shrink in the course of drying and their dimensions are therefore smaller than indicated by the code name.

All the German nitrocellulose powders are marked with the letters Nz. This designation is followed by letters indicating the shape of the grain and its dimensions.

RP.—(Röhrenpulver) tubular powder followed by figures (in brackets) indicating the length of the tubes, and the outer and inner diameter, e.g. RP (150·2·1) means a tubular powder 150 mm long outer diameter 2 mm, inner diameter 1 mm.

St. P.—(Streifenpulver) indicates strip powder: e.g. St. P. 150·15·1 means strip 150 mm long, 15 mm wide, 1 mm thick.

Bl. P. (Blättchenpulver) indicates square plate powder, followed by dimensions as above, e.g. Bl. P. (4·4·1).

Rg. P. (Ringpulver) is ring powder—and the figures indicate its dimensions: (thickness, outer diameter, inner diameter) e.g. Rg. P. (3.25/5).

Pl. P. (Plattenpulver) is plate or disk having diameter, thickness as indicated, e.g. Pl. P. (50·0,2).

N. P. (Nudelpulver) is cylindrical (macaroni) powder of the length and diameter, indicated e.g. N. P. (1,5·1,5).

German double base powders are also marked with figures or letters indicating their calorific values. Nitrocellulose powders had no such marks, as their calorific value is approximately the same in all types of powder.

The German nomenclature for double base powder is given in the appropriate chapter — p. 660.

MANUFACTURE OF NITROCELLULOSE POWDER

THE DEHYDRATION OF NITROCELLULOSE

For safety purposes nitrocellulose is delivered to the factory in a wet state and before it is partially dissolved in a mixture of alcohol and ether the water must be removed since this prevents the process of swelling and dissolution.

Formerly the water was removed by drying the nitrocellulose. This operation is dangerous due to the high sensitiveness of the dry nitrocellulose to friction, impact and static electricity. The dust of dry nitrocellulose either suspended in the air or spilled on the floor, or on radiators etc. is particularly dangerous, hence the drying of wet nitrocellulose has caused many accidents.

In the manufacture of nitrocellulose powders the water is displaced with alcohol. This method was proposed by Lundholm and Sayers [3] and widely used in many countries [4, 5]. Despite the simplicity of the idea the dehydration process is rather complicated. It is influenced by such factors as the solubility of nitrocellulose in alcohol and the ability of nitrocellulose to swell under the influence of alcohol: the lower the solubility of nitrocellulose in alcohol, the more easily dehydrated with alcohol. Since, however, the solubility of nitrocellulose depends primarily on its nitrogen content dehydration is easier with the higher nitrated types of nitrocellulose.

The advantage of dehydrating nitrocellulose with alcohol lies in the fact that any residual alcohol may be subsequently included in the solvent. The amount of residual alcohol in nitrocellulose depends not only upon the pressure applied in the dehydration press, but also on the type of nitrocellulose, i.e. it is somewhat larger in more highly nitrated nitrocellulose. Nitrocellulose made from wood cellulose swells in alcohol more readily than that made from cotton which is why the former retains more alcohol and more water.

The dehydration process is based primarily on the ability of alcohol to displace water. Since, however, the water is not always perfectly displaced the alcohol becomes partly mixed with water. In addition, some of the water is adsorbed by the nitrocellulose and cannot readily be removed, which causes a further dilution of the alcohol. The subsequent portions of fresh alcohol displace the dilute alcohol, the residual alcohol adsorbed by nitrocellulose is mixed with concentrated alcohol, the latter is displaced by fresh alcohol etc. This course of the operation is illustrated by variations in the concentration of alcohol in the liquid flowing out of the dehydration apparatus (Figs. 203-205).

It has been shown that washing out nitrocellulose with alcohol also serves another purpose; it dissolves and removes from the nitrocellulose degradation products which for the most part are known to be of low stability (Berl and Delpy [6]). Thus, the removal of water from nitrocellulose by displacement may be considered as an additional stabilization process.

The accuracy of the process, its duration, and the variation in the concentration

of alcohol, depend to a great extent on the apparatus used for dehydration. The yield of the recovered alcohol also depends upon the apparatus and the particular process used.

Dehydration with centrifuges

The simplest method of dehydration is by centrifuging. Various types may be used e.g. power driven centrifuges usually with a capacity of 30 kg of nitrocellulose (calculated on the weight of the dry substance). Power drive, however, is somewhat risky if the nitrocellulose is moistened only with alcohol, since it very quickly dries up and can penetrate into the driving gear. For this reason a special centrifuge driven by means of a water turbine was designed (Figs. 197 and 198). The basket of this

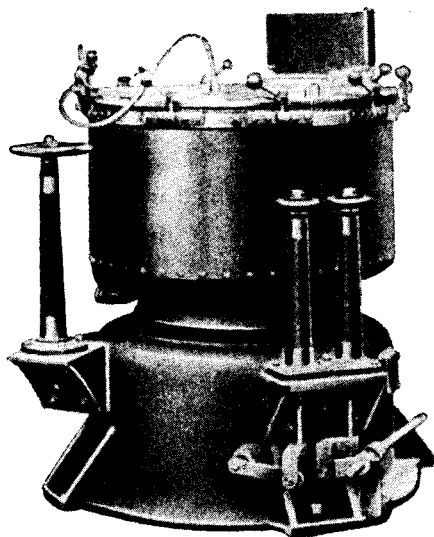

FIG. 197. Centrifuge for dehydration of nitrocellulose with alcohol, according to Brunswig [7].

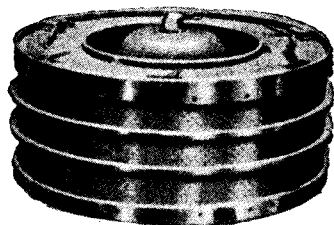
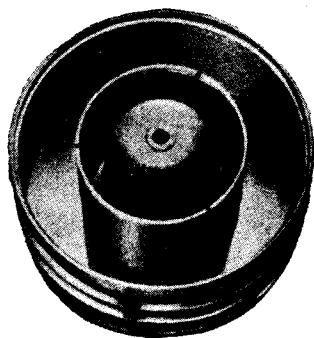

FIG. 198. Basket of a dehydration centrifuge, according to Brunswig [7].

centrifuge can rotate at two speeds: 1000–1200 r.p.m. and 500–600 r.p.m. The rate of rotation should be reduced when introducing alcohol, after which it is increased to remove the liquid. Some centrifuge baskets have a double wall of perforated sheet (Fig. 198), the annular space between the two walls being lined with a strong filter cloth. The basket is loaded with 60 kg (dry substance) of wet nitrocellulose. The cloth acts as a filter and retains the nitrocellulose in the basket.

After the centrifuge has been loaded it is closed with a lid fixed with clamps. The basket of the centrifuge is set in slow motion and a pipe that injects alcohol into the space between the shaft and the outer wall of the basket is introduced through a special hole in the lid. The pipe has numerous delivery nozzles facing the outer wall of the basket. At first 80% alcohol from the previous dehydration is introduced and the motion of the basket is speeded up to drain away a part of the water and alcohol. Further alcohol is added in several portions, the centrifuge being slowed down and then speeded up after each injection. When the content of alcohol in the drained liquid reaches about 60%, fresh 96% alcohol is introduced. This operation is repeated 2-3 times as described above until the concentration of alcohol flowing out of the centrifuge reaches 92%. The amount of alcohol supplied each time is established experimentally for a given centrifuge.

When operating the centrifuge described above with a load of 60 kg of nitrocellulose the alcohol is usually injected in four portions:

- I *ca.* 40 l. of 80% alcohol
- II *ca.* 40 l. of 80% alcohol
- III *ca.* 30 l. of 95% alcohol
- IV *ca.* 30 l. of 95% alcohol

The nitrocellulose is then centrifuged to a definite alcohol content. The dehydration of one batch of nitrocellulose requires approximately 1 hr.

The best method for recovering the alcohol is to collect the 60-70% alcohol and rectify it and to collect the 80% alcohol separately and use it for the dehydration of the next batch of nitrocellulose. 125 l. of 95% alcohol is consumed per 100 kg of dehydrated nitrocellulose; of this 30-35 l. remain in the nitrocellulose and about 90 l. are recovered by rectification.

After dehydration 30-35% alcohol remains in the nitrocellulose and is subsequently utilized as a part of the solvent. The final centrifuging should last until the content of residual alcohol remains constant. It is found that with certain forms of nitrocellulose (e.g. those made from wood cellulose) the removal of excess alcohol by centrifuging is difficult. In such cases centrifuging should last somewhat longer. If the content of alcohol in the nitrocellulose is too high, more solvent will be put at a later stage of dilution, or its composition is altered to increase the content of alcohol in it.

The centrifuged nitrocellulose is taken out of the centrifuge together with the cloth. Since the cloth and its charge adheres strongly to the wall of the basket, it may be necessary to use aluminium spades to separate it. The unloaded nitrocellulose is weighed. This gives the content of alcohol, the weight of the dry substance being known. The alcohol-damp nitrocellulose is broken up into lumps and loaded into cylindrical cans made of strong galvanized iron, hermetically sealed. Each can contains approximately 20 kg of nitrocellulose (calculated as dry substance).

The nitrocellulose to be loaded into the centrifuge may be in lump form or compressed (taken directly from the transportation cases). To attain uniformity in the

operation of the centrifuge it is recommended that before loading the nitrocellulose is rubbed through a 1–2 cm mesh sieve either manually or mechanically. Manual rubbing may be carried out either by hand or with wooden paddles. For mechanical rubbing Nussbaumer's [8] apparatus (Fig. 199) may be used, in which bronze scrapers fixed on horizontal shafts (1) rotating around a vertical shaft are clamped down to screen (2) made of brass or aluminium wire. Swivel dampers (3) are used to load the rubbed nitrocellulose into sacks.

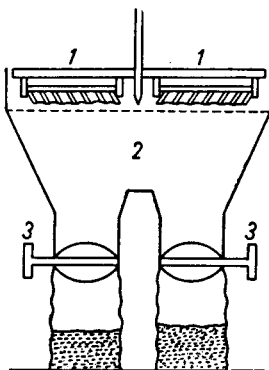

FIG. 199. Schematic view of Nussbaumer's apparatus for rubbing nitrocellulose before dehydration.

Dehydration in presses

Another method for dehydrating nitrocellulose is based on the use of pneumatic or hydraulic presses. Dehydration in pneumatic presses (diffusers) (Fig. 200) consists of filling the cylinder of the press with wet guncotton squeezed out of the tank under

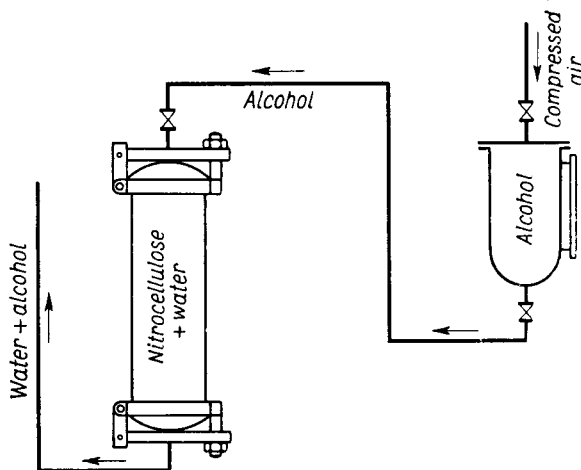

FIG. 200. Schematic view of a pneumatic press (a pressure diffuser) for dehydration of nitrocellulose with alcohol.

a pressure of 5–8 atm. The cylinder is then closed and the alcohol is forced into it from above by compressed air (5–8) atm. The water, followed by dilute alcohol and finally by concentrated alcohol flows out from below.

After dehydration in a diffuser, the nitrocellulose contains about 50% of alcohol. This is obviously too much and on removal from the cylinder the nitrocellulose is again subjected to pressure in a hydraulic press (100–200 kg/cm²) to reduce the content of alcohol to 30–35%. The method described above requires an expensive installation, more numerous staff and takes longer than dehydration in centrifuges or in hydraulic presses. It does not seem to be in use any more.

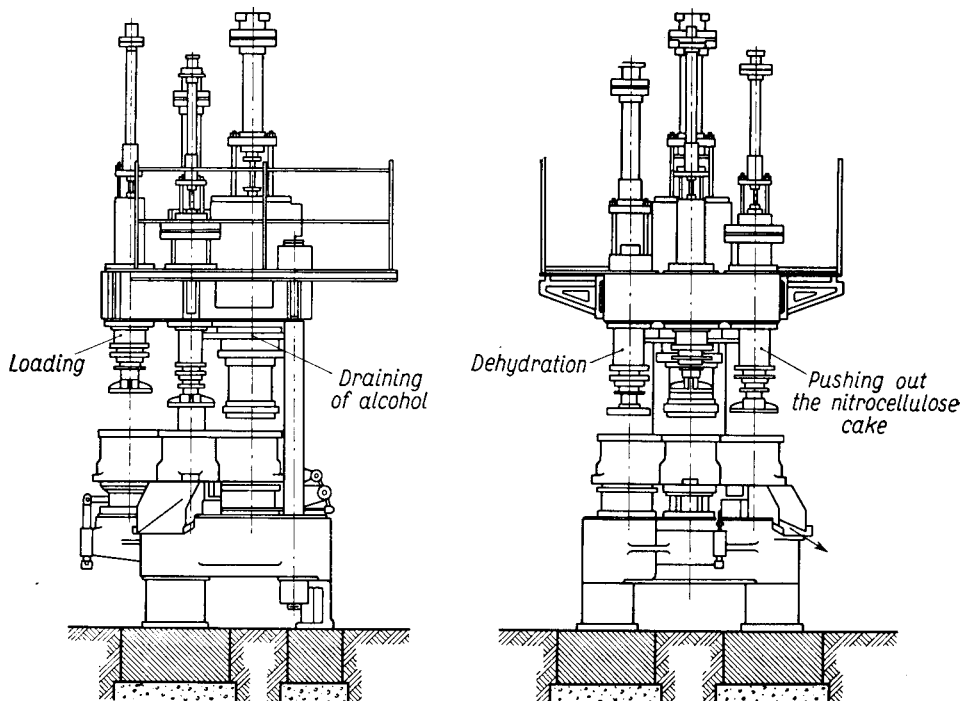

FIG. 201. Champigneul hydraulic press for dehydration of nitrocellulose.

Dehydration in hydraulic presses is the most general method now in use. The Champigneul press (Fig. 201) consists of four cylinders rotating around a vertical shaft and of four pistons taking positions accommodating to the movements of the pots. The pistons can move in a vertical direction and always perform the same successive operations, whereas the set of cylinders rotates, each one taking four positions in turn, corresponding to four separate operations. The functioning of the press is illustrated by the diagram in Fig. 202. The arrangement of the cylinders as seen from above is shown in section (I). Section (II) represents all four cylinders as developed on one plane along $AOB'OA'OB$. As can be seen, the diameters of each particular piston are different. This is important since the pressure on the whole

piston is proportional to r^2 (r =radius of the piston). The bottoms of the cylinders constitute a lower immobile section (supports) non-rotatable around shaft O , with tubular conduits for the outflow of alcohol.

The operation proceeds as follows: a brass mesh and a linen disk are put on "the bottom" of a cylinder at position I , and then 20 kg (dry substance) of wet nitrocellulose is poured in from above. Commonly used types of nitrocellulose (guncotton with collodion cotton) are packed alternately in layers, which in fact

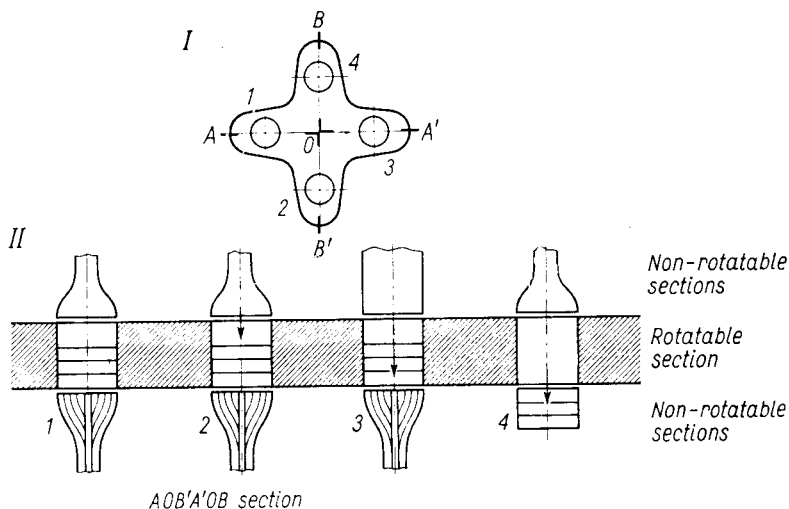

FIG. 202. Diagrammatic view of the operation of the four cylinders of a dehydrating press.

constitutes a preliminary mixing. The upper and lower layers are made of the type of nitrocellulose used in the larger quantity. The nitrocellulose is held in place by the lower piston. The upper piston rises and falls, thus ramming the load as it is poured, causing the brass mesh and linen disk to adhere to the lower surface of the load. The pressure of the piston may range from 25–50 kg/cm².

After the cylinder has been loaded at position (I), the set of cylinders is turned through 90° so that cylinder (I) moves to position (2). Here the bottom of the cylinder is formed by a lower piston in which there are furrows and conduits to drain away alcohol and water. About 20 l. of 95–96% refined alcohol is now poured onto the layer of compressed nitrocellulose and forced through this layer by the upper piston at pressures of 50–100 kg/cm². The water, dilute alcohol and finally less dilute alcohol flow out through the conduits in the lower piston.

After the upper piston has touched the layer of nitrocellulose, i.e. after the alcohol has been forced through the dehydrated material, the upper piston rises, while the lower one moves down and the set of cylinders again turns through 90°, so that the cylinder which started from position (I) through (2) now takes position (3). Here the lower piston is again fitted with conduits to drain away the alcohol. The upper

piston at position (3) has the largest diameter and may develop pressures of 200–300 kg/cm². It reduces the alcohol content to 30–35%. After the upper piston has been raised and the lower one lowered, the set of cylinders once again moves through 90°. The cylinder passes from position (3) to position (4), where the upper piston pushes the cake of dehydrated nitrocellulose down. The brass mesh and linen disk are removed and the cake is broken up with a wooden mallet and quickly rubbed through a coarse (1–2 cm mesh) brass sieve. The screened nitrocellulose is weighed to determine its alcohol content. The mesh and linen disk are re-placed on the bottom of the cylinder at position (1), before starting the cycle again with another load of nitrocellulose.

Dehydration using this type of press precludes the recovery of dilute alcohol. Only 92–96% alcohol is used for dehydration. The waste alcohol below a certain concentration (usually 50%) is discarded. Any of a higher concentration is sent to rectification.

Ponchon [9] studied the course of dehydration of nitrocellulose in a Champigneul press, and drew the graphs indicating how water and alcohol are displaced in each position of the cylinder. The graphs in Fig. 203 denote the process of dehydration

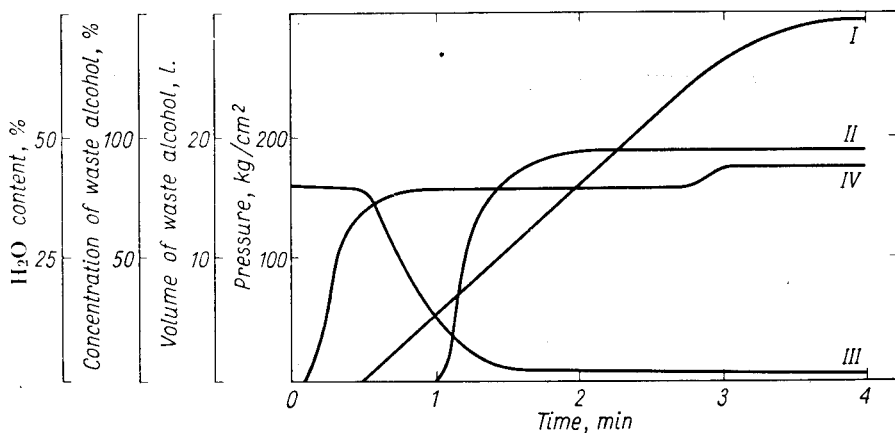

FIG. 203. Characteristics of the dehydration process of nitrocellulose in a Champigneul press (position (2) of the cylinder).

when the cylinder is at position (2). Curve *I* shows the change in volume, curve *II* the change in concentration of waste alcohol, curve *III* the change in water content of the nitrocellulose and curve *IV* the pressure indicated by the manometer. Changes in all these values are expressed as a function of time. A graph illustrating the process of dehydration when the cylinder is at position (3) (separation of alcohol) is shown in Fig. 204. The curves *I–IV* denote the same relationships as in Fig. 203 and in addition curve *V* shows the decrease in alcohol content of the nitrocellulose.

Ponchon also produced a graph (Fig. 205) showing the difference between the dehydration of CP₁ nitrocellulose (containing 1.5% of soluble in alcohol)

and CP₂ nitrocellulose (containing 5.2% of soluble in alcohol). The graph indicates for both forms of nitrocellulose the volume of waste alcohol (broken lines) and the pressure within the press (continuous lines) against time. The graph shows that the pressure necessary to displace the water is lower with guncotton (CP₁ nitrocellulose) than with collodion cotton (CP₂ nitrocellulose). In CP₁ the alcohol flows

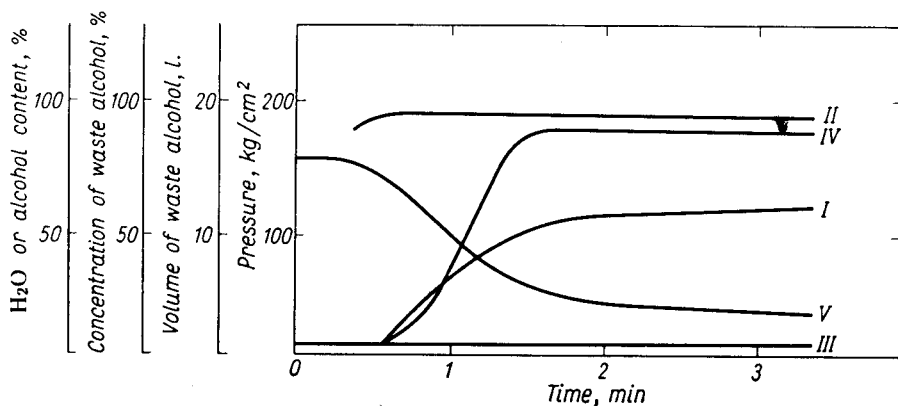

FIG. 204. Characteristics of the dehydration process of nitrocellulose in a Champigneul press (position (3) of the cylinder).

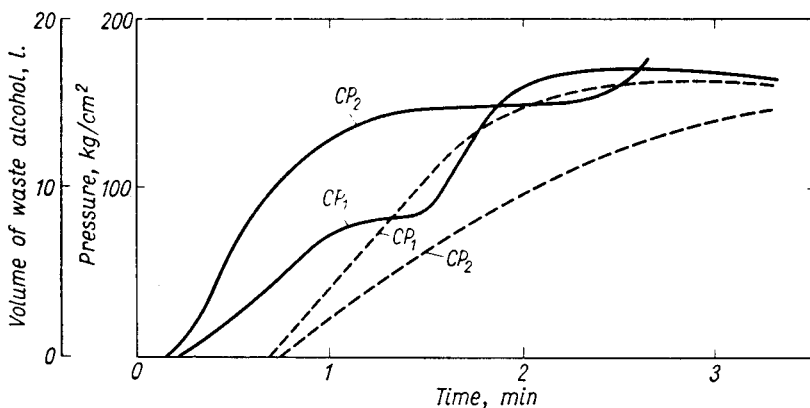

FIG. 205. Comparison of the course of dehydration of CP₁ and CP₂ nitrocelluloses.

out more rapidly. These findings show that CP₁ is dehydrated more readily than CP₂.

Ponchon's experiment led him to conclude that the most advantageous arrangement lies in placing the CP₂ layer on the bottom of the cylinder and the CP₁ layer in the upper part.

As shown in Ponchon's graphs the use of a hydraulic press leads to very distinct changes in the concentration of alcohol on dehydration and permits the collection

of alcohol of a definite concentration at a given time. Alcohol of approximately 50% concentration is usually collected and rectified.

Svetlov [10] quotes the following figures characteristic of the output of the Champagneul press. In one working cycle of the press 20 kg of nitrocellulose containing about 6 kg of absolute alcohol (23% of the total weight) and about 0.4 kg of water (1.5% of the total weight) are obtained. In the first stage of the operation (positions 1 and 2) 12–14 kg of dilute 40–50% alcohol flows out, and in the second stage (position 3) about 7 kg of 93% alcohol. One working cycle lasts up to 2 min. In one hour approximately 30 charges of nitrocellulose of 20 kg each are dehydrated, e.g. 600 kg/hr.

According to Ponchon 110 kg of 93% alcohol are used for the dehydration of 100 kg of nitrocellulose (dry weight). In French factories (1917) an average of 33 kg of 42–52% waste alcohol was recovered and returned for rectification.

The consumption of energy per 1000 kg of nitrocellulose (dry) is 13.5 kWh.

The Becker and van Hüllen (Krefeld) press is of another design. In this press the wet non-centrifuged nitrocellulose is first dehydrated by removal of up to 20–30% of its water content, and then subjected to further dehydration with alcohol. Partial dehydration of the nitrocellulose takes place in the feeding screw used with this press.

Rectification of alcohol from dehydration

Alcohol from dehydration contains a certain quantity of nitrocellulose, i.e. its soluble fractions, mostly degraded, and a certain amount in suspension. Experiments have shown that about 2.2 g of dissolved nitrocellulose and 1.3 g of nitrocellulose in suspension—a total 3.5 g—occur in 1 l. of 70% alcohol from centrifuges. Sometimes however, the content of nitrocellulose in the alcohol may reach 10–12 g/l.

The nitrocellulose present in suspension readily passes through filters, and should therefore be separated by decanting the alcohol out of the tank in which the waste alcohol is stored. In this manner the nitrocellulose content in the waste alcohol is reduced to 2–3 g/l. In some factories nitrocellulose is removed more completely by diluting the alcohol to about 40% with water (from washing the powder, and therefore containing a small amount of alcohol). By this means a certain quantity of the nitrocellulose is precipitated as sludge. After settling, the alcohol is decanted. This method, however, is troublesome and not commonly used, because the residual nitrocellulose in solution and traces of its suspension in alcohol are liable to decomposition in the course of prolonged heating during distillation. The decomposition of residual nitrocellulose in a distillation still (vat) has several times caused explosions. Moreover due to the decomposition of nitrocellulose there are traces of nitrites, nitrates and even nitric oxides in the distillate. To avoid this, it is advisable to add calcium oxide to the distillation vat, using 1 kg per 100 l. of alcohol. This causes hydrolysis of the nitrocellulose and neutralizes the products of hydrolysis. In addition the vat should be freed from solid residue as often as possible. Losses on rectification amount to approximately 1.5% alcohol.

THE PREPARATION OF NITROCELLULOSE MIXTURES

Nitrocellulose for the manufacture of powder must meet requirements of chemical stability, nitrogen content and solubility in a mixture of alcohol and ether according to the regulations discussed in the chapter on nitrocellulose.

For the manufacture of most kinds of semi-colloidal nitrocellulose powders with a volatile solvent, and recently also for the manufacture of solventless nitroglycerine powders, a mixture of two forms of guncotton is used: high nitrated guncotton, insoluble in a mixture of alcohol and ether, and low nitrated collodion cotton soluble in a mixture of alcohol and ether. In some countries (U.S.A. and U.S.S.R.) pyrocollodion cotton is used and for powders requiring a high nitrogen content, a mixture of pyrocollodion and guncotton.

Since nitrocellulose is stored and weighed in a wet condition (25–30% water), the moisture content should be determined accurately before batching. The powder plant usually receives nitrocellulose in semi-sealed containers. Since these are not uniformly tight the moisture content is liable to some variation. This makes batching more difficult, less accurate and even completely faulty. It is therefore advisable to equalize the moistness of the nitrocellulose by unloading it into concrete pits, holding 5000 to 20,000 kg of nitrocellulose (dry weight) hermetically closed with a sheet iron cover fitted with a rubber seal and storing it there for a few days. The nitrocellulose is then analysed for its water content, nitrogen content and its solubility (dry weight) in a mixture of alcohol and ether. Samples are taken from several places to make the analysis more reliable.

After analysis each form of nitrocellulose (guncotton, collodion cotton, pyrocollodion cotton) is batched separately into a linen bag which for convenience and safety is stored in an air-tight iron vessel (to protect the nitrocellulose from drying up and becoming dusty). Nitrocellulose is batched by charges, the size of which depends on the dimensions and the type of apparatus used. In France, for instance, a total charge of nitrocellulose (CP₁ and CP₂) is 20 kg when dehydrated in a hydraulic press or 30 kg when dehydrated in a centrifuge.

The more modern approach to the problem of mixing nitrocellulose consists of mixing defined types of nitrocellulose in the nitrocellulose factory itself. In this case the two forms of nitrocellulose are mixed under water in mixers as described in Vol. II, p. 374. The water is then centrifuged and the mixture dehydrated with alcohol. This method, however, creates certain inconvenience to the powder factory which loses the possibility of changing (within certain limits) the composition of the mixtures, i.e. nitrogen content and total solubility of nitrocellulose. The powder factory is therefore compelled to limit the number of factors which can be varied to obtain the powder of required ballistic properties.

When treating the nitrocellulose mixture with solvent, only collodion cotton is dissolved and converted into a colloidal state. Guncotton is incorporated into the colloidal mass in the form of fibres. Thus by the solubility of a mixture of nitrocelluloses in a mixture of alcohol and ether, we mean the total solubility of the mixture.

The batching of nitrocellulose consists of weighing the guncotton and collodion cotton in a ratio which gives a mixture of suitable nitrogen content with the required total solubility.

The following rule is helpful in calculating the composition of a mixture. Suppose that a mixture of 30% total solubility is needed consisting of guncotton (CP₁) of 10% solubility and collodion cotton (CP₂) of 95% solubility. To prepare it 65 parts by weight of CP₁ and 20 parts by weight of CP₂ have to be mixed.

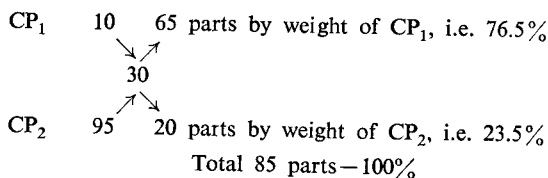

After the ingredients have been mixed the total nitrogen content in the mixture so obtained must be checked.

The nitrogen content and solubility of the nitrocellulose mixture must be maintained within the following limits according to its intended use (Table 177).

TABLE 177

	Total solubility	Nitrogen content
Rifle powder	18-25%	13.1-13.3%
Powder for smaller calibre cannon (below 90 mm)	25-35%	12.8-13.1%
Powder for heavier calibre cannon	35-45%	12.5-12.9%

The lower the nitrogen content and the higher the solubility of the nitrocellulose in a given solvent, the more slowly the powder made of it will burn. Thus in matching the composition of a mixture of guncotton and collodion cotton to obtain the required total solubility the burning rate of the powder can be regulated within certain limits. E.g. in France, for modern rifle powders, which are faster burning than cannon powders, the mixture of CP₁ and CP₂ is so balanced that the total solubility is 15-20% while for the earlier type of powder Bn₃F (Le Bel rifle) it is 25-30%. For small calibre field guns (75 mm) powder, a total solubility of 30-35% is chosen. For 105 mm field guns powder and for small calibre naval guns it is 40% and for heavy calibre guns 40-50%.

If the powder is made of pyrocellulose, only part of it dissolves in the solvent (usually 60-70%) while a certain amount of the substance remains in fibre form.

PARTIAL DISSOLUTION OF NITROCELLULOSE

For the manufacture of nitrocellulose powder a volatile solvent is used, i.e. a mixture of alcohol with ether in a weight ratio of about 2 : 1.

The alcohol (usually refined to 95–96%) must not be acid. To make a 100 cm³ sample of alcohol neutral towards phenolphthalein no more than 1.6 cm³ of 0.1 *N* NaOH is required. A larger quantity of acid is detrimental since it may adversely influence its stability and gives a dark powder. The alcohol should not contain nitrites. A nitrocellulose powder plant should be equipped with a plant for the distillation of alcohol.

Ether, in its common commercial form, is sufficiently pure to be used in admixture with alcohol. Its acid content should not exceed 40 mg (calculated as H₂SO₄) per litre, nor should it contain nitrites. A nitrocellulose powder plant must include a plant for the manufacture of ether.

In France, two types of an alcohol–ether mixtures are used for the manufacture of nitrocellulose powder specified in terms of Baumé degrees:

(1) 56° ether consisting of 64 parts by weight of ether and 36 parts by weight of alcohol.

(2) 54° ether consisting of 56 parts by weight of ether and 44 parts by weight of alcohol.

Nitrocellulose dissolves more readily in 56° ether which is therefore used more often than 54° ether. If, however, the nitrocellulose is very soluble and gives a powder with too slow a rate of burning, the use of 54° ether is recommended, i.e. a solvent which leaves more insoluble material, thus giving a more fibrous powder.

The volatile solvent (alcohol–ether mixture) is used in such an amount that the dough is fairly loose but sticks when pressed between the fingers. The actual amount depends to a great extent on the properties of the nitrocellulose, since some forms require more solvent than others. The amount of solvent is usually determined by experiment. It ranges from 70–150 parts per 100 parts by weight of a mixture of nitrocellulose (dry substance).

With wood nitrocellulose smaller amounts of solvent are used (70–90%). This is accounted for by the lower degree of polymerization of wood cellulose in comparison with that of cotton. With its lower degree of polymerization wood nitrocellulose swells and dissolves more readily, producing solutions of a relatively low viscosity.

With pyrocellulose which contains 60–70% of material soluble in an alcohol–ether mixture, the use of 70–80 parts by weight of solvent per 100 parts of nitrocellulose is sufficient.

A volatile solvent is not used for the manufacture of completely colloidal powders containing nitroglycerine, with the exception of British cordite. For this, acetone is used, which is a solvent well fitted for both high nitrated cellulose (guncotton of 13% N) and nitroglycerine. Small amounts of acetone are also sometimes employed as an auxiliary solvent for the manufacture of ballistite. During World War I, when there was a shortage of acetone an alcohol–ether mixture was adopted as a substitute for the manufacture of cordite. It then became necessary to use a lower nitrated cellulose soluble in this solvent (RDB cordite). This is discussed more fully in the chapter on nitroglycerine powders.

Nitrocellulose is gelatinized (dissolved) and the powder dough is prepared in kneaders so that the dough-like mass is thoroughly mixed. Werner-Pfleiderer type kneaders (Figs. 206, 207, 208 and 209) are most commonly used. They consist of a trough made of bronze (surrounded by a cooling jacket) in which two powerful bronze stirrers in the form of worm-shaped blades rotate in opposite directions, one twice as fast as the other. Effective kneading combined with simultaneous mixing is attained by the movement of the stirrers downwards in the centre and upwards by the walls. The angular speed of the slower stirrer is 20–30 r.p.m. and of the faster one 40–60 r.p.m. The trough is fitted with an outer cooling jacket.

The kneaders in use are of varying capacity, and usually hold a charge of 60 kg of dehydrated nitrocellulose (dry weight) containing alcohol. After the kneader has been loaded its lid is closed (until then the lid is slung on chains from a block attached to the ceiling) and screwed down to the trough as tightly as possible. The stirrers are then set in motion; the ether is fed through a conduit in the lid as is the additional quantity of alcohol. Simultaneously the stabilizer is introduced in such a manner that diphenylamine weighed out in a silk bag is placed into a small container attached to the lid. The latter is connected with the conduit feeding the ether so that the ether flowing down from the batcher to the kneader, on passing through the container with diphenylamine, dissolves it and thus introduces it into the powder dough. To facilitate checking whether or not diphenylamine is present in all the containers, it is advisable to fit an inspection window.

Kneading requires 2.5–3 hr, although in exceptional cases if rapid manufacture is necessary, this period may be shortened to 1–1.5 hr.

Since the mass is heated up during kneading, due to friction, cold water is fed to the cooling jacket during the whole time of kneading so that the temperature does not exceed 30°C, otherwise the ether evaporates. Dissolution may be incomplete and excess pressure may be produced within the kneader which may blow off the lid when it is unscrewed.

When the kneading is finished, the lid is unscrewed and lifted with the block, the stirrers are set to rotate in the opposite direction (upwards in the centre and downwards by the walls) and the trough is tilted up by a special mechanism driven manually or mechanically (Fig. 210) so that the dough falls from the trough into two containers previously placed below. To prevent spilling the dough the containers are covered with a protective hopper made of sheet brass or leather. As a container is filled, the dough is rammed with bronze rammers mounted on wooden handles. Ramming gives a more uniform dough and removes the air. This at a later stage, facilitates pressing.

The containers loaded with the dough are hermetically closed. When unloading, a sample is taken from each kneader to be sent to the testing laboratory to check the presence of diphenylamine. A drop of concentrated sulphuric acid on a sample of the dough gives a blue coloration if diphenylamine is present. If the test is negative the dough is returned for kneading once again with the addition of the required amount of diphenylamine.

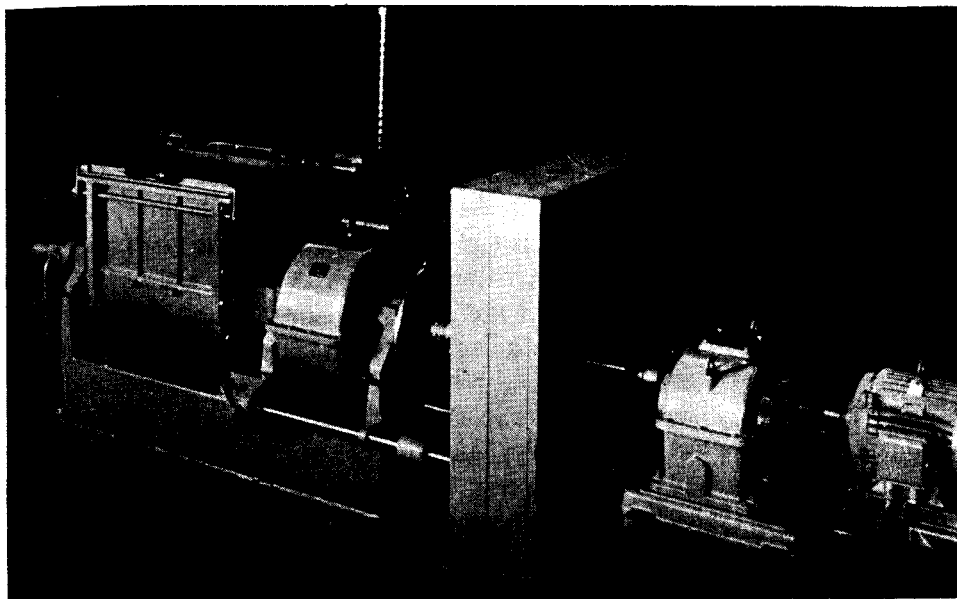

FIG. 206. Werner-Pfleiderer kneader with electric motor shown behind a wall (Courtesy Werner & Pfleiderer, Maschinenfabriken und Ofenbau, Stuttgart).

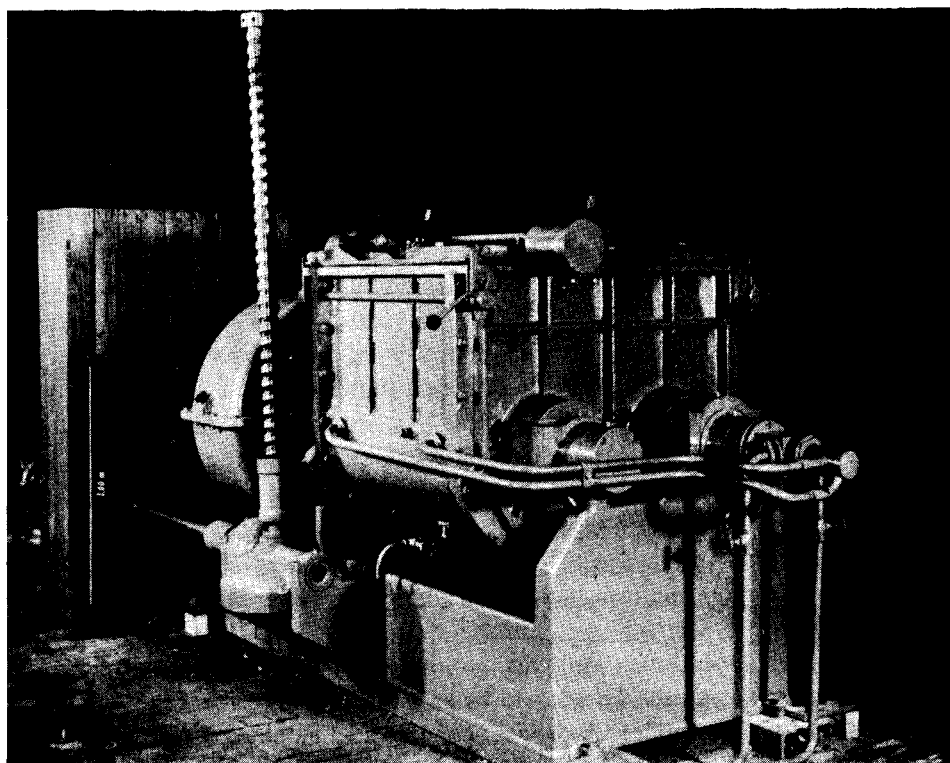

FIG. 207. Werner-Pfleiderer kneader at work (Courtesy Werner & Pfleiderer, Maschinenfabriken und Ofenbau, Stuttgart).

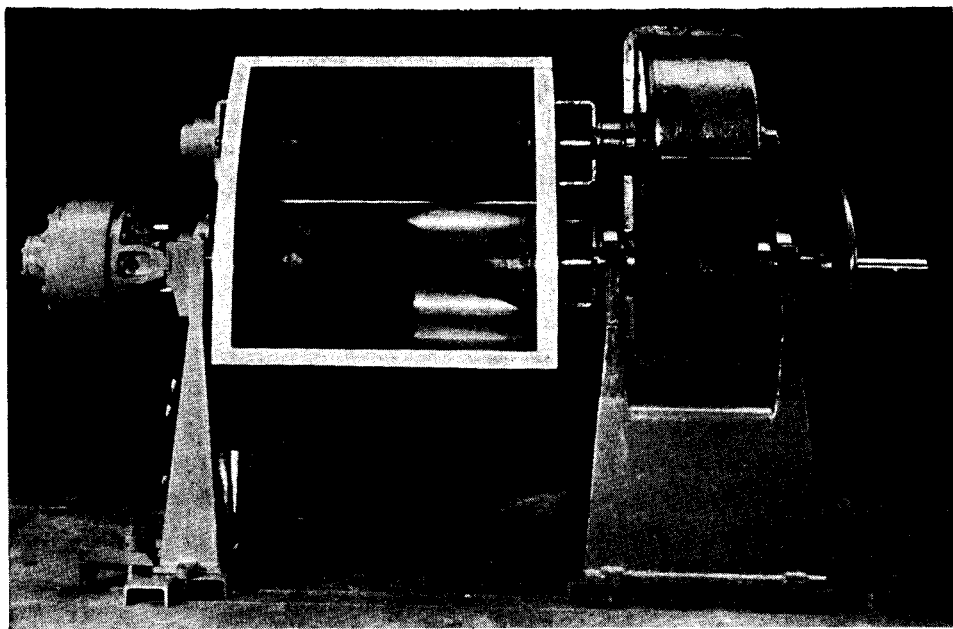

FIG. 208. Werner-Pfleiderer kneader in unloading position (open) (Courtesy Werner & Pfeleiderer, Maschinenfabriken und Ofenbau, Stuttgart).

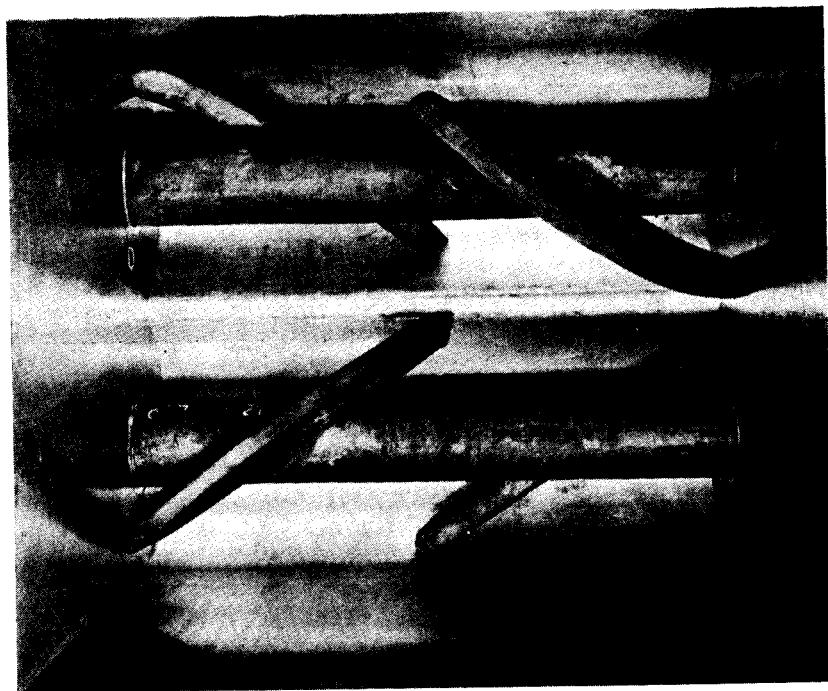

FIG. 209. View of paddles (Courtesy Werner & Pfeleiderer, Maschinenfabriken und Ofenbau, Stuttgart).

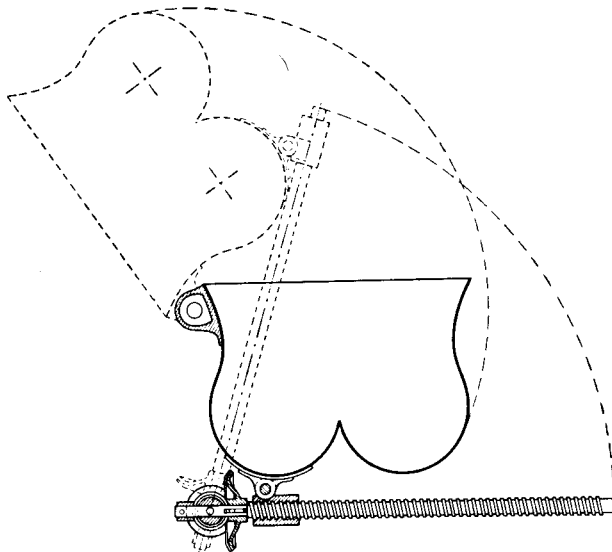

FIG. 210. Mechanism for tilting the kneader.

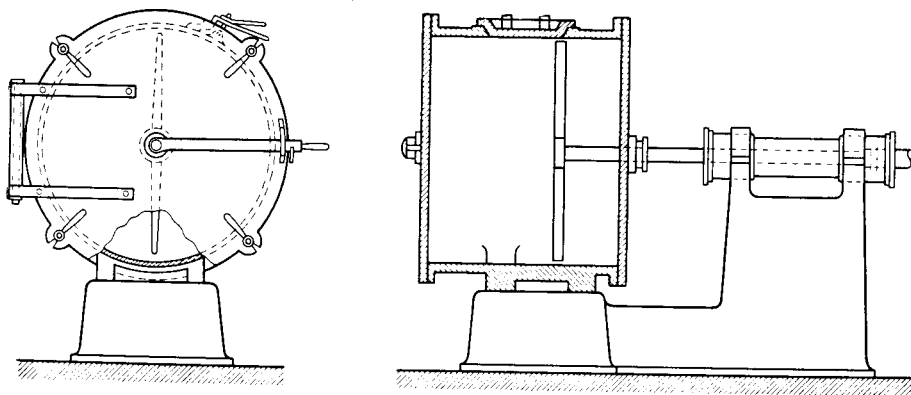

FIG. 211. A diagram of a Chaudel-Page kneader.

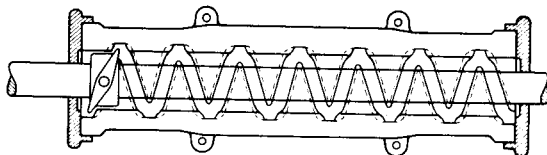

FIG. 212. A diagram of the mechanism for moving the stirrer of a Chaudel-Page kneader in translatory and angular motion, according to Yegorov [11].

In France Chaudel–Page kneaders (Fig. 211) are in general use. These take the form of an iron cylinder in which an iron bar rotates about a horizontal shaft [11]. The bar performs an angular-translatory motion, driven by the mechanism sketched in Fig. 212. A spur-gear rotates in a box with interior left-hand and right-hand threads. The spur-gear is fastened to the horizontal shaft. It turns forwards in the grooves of one of the threads with a translatory motion of the shaft in one direction (e.g. to the right). When the spur-gear reaches the end of the box further movement in this direction becomes impossible. As it turns it falls into the threads imparting a translatory motion to the shaft in the opposite direction. Thus it travels to and fro, and kneads and mixes the contents of the cylindrical kneader throughout its full length.

60 kg of dehydrated nitrocellulose containing alcohol is loaded into the kneader, through a manhole in the upper section of the cylinder. It is unloaded through the lateral cover. Kneading takes as long as that in a Werner–Pfleiderer kneader.

The advantage of kneaders of the Chaudel–Page type is that they take up considerably less space than Werner–Pfleiderer kneaders. Premises which provide accommodation for six kneaders of the Chaudel–Page type can hold at most three Werner–Pfleiderer type kneaders.

Safety in operating kneaders is, in general, fairly high. This stage of production is considered to be one of the safest in the manufacture of nitrocellulose powders, now that it is known how to avoid the danger created by electrification of the solvent, especially of ether. It was observed that numerous explosions and inflammations of ether were caused by discharges of static electricity, e.g. there were accidents caused by the ignition of ether when the valve feeding it to the kneader was opened. Such accidents ceased when all containers and pipes containing solvents were carefully earthed. The kneaders must also be earthed. The equipment driving them—engines, transmission gears etc.—should be situated in a separate room.

The moment of unloading is particularly dangerous since large quantities of ether vapours mix with the air to form an explosive mixture. At this moment any impact of metal against metal which may produce sparks is dangerous (e.g. allowing the heavy lid to strike against the rim of the kneader in the Werner–Pfleiderer system).

Dough containing a considerable amount of solvent is non-flammable and almost non-explosive. Only the solvent burns easily and only if there is an access of air. Indeed, the solvent strongly “phlegmatizes” the nitrocellulose, considerably reducing its explosiveness.

In some countries (e.g. the U.S.A.) the nitrocellulose–alcohol–ether dough is subjected to an additional treatment intended to improving its homogeneity.

This consists of “blocking” which involves pressing the mass for several minutes at a pressure of *ca.* 200 kg/cm² (3000 lb/in²). The block thus formed is transferred to another press of a type much similar to the extrusion press (Fig. 213). Here the dough is forced through a series of screens and perforated plates. This is referred to as “macaroni” pressing owing to the shape of the extruded threads.

The shredded, "macaronied" dough is introduced into the extrusion press, as described in the next paragraph.

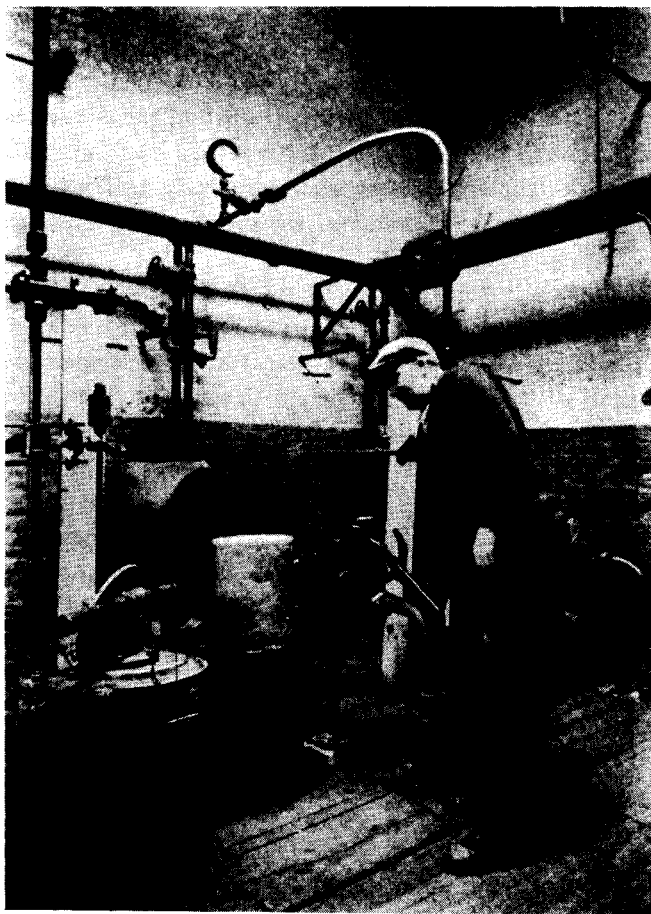

FIG. 213. Blocking press at E. I. du Pont de Nemours and Co. factory, according to Davis [12].

SHAPING THE DOUGH

The dough is usually pressed into the desired shape by extruding it from a hydraulic press. Formerly, the dough was rolled into sheets by passing it between rolls, predried and cut into flakes or strips. This method is retained for the manufacture of some types of nitrocellulose powder, i.e. very fine ones with a very high rate of burning ("coefficient of vivacity"*), used as sporting, pistol, and blank powders.

* According to French nomenclature "coefficient of vivacity" (coefficient de vivacité) is the rate of increase of pressure during the burning of the main part of the grain of smokeless powders in a closed vessel (p. 530).

Rolling is the most desirable method for obtaining flakes of very low web thickness since it is difficult to obtain strips of a thickness below 0.40 mm by pressing and there is much waste, due to the clogging of the die slots and the folding and tearing of the extruded strips (rolls are shown on Fig. 260).

For rolling the dough should contain a relatively small amount of solvent (should be "dry") otherwise it adheres to the surface of the rolls and is then difficult to remove. On an average, dough to be rolled should contain less solvent (about 50%) than that subjected to pressing. Rolls especially adapted for the manufacture of nitroglycerine powder are most widely used, but not heated.

The use of hydraulic presses makes it possible not only to shape the powders into flakes or strips but also into cords or tubes or even into more complicated profiles. The operation of the press consists of the filling the cylinder so that the highest possible density is obtained with all air spaces eliminated. The piston of the press forces the mass first through a sieve that removes mechanical impurities and then through the die giving it a required shape. It is particularly important to remove all impurities from the dough, otherwise they may interfere with pressing and may distort the shape of the product—troubles that obviously reduce the efficiency of operation and increase operating expenses. If the dough is "macaroni" pressed (see p. 589) it is already filtered and homogenized and extrusion to the final shape is much facilitated.

The extruded strips, cords or tubes are forced from the die directly on to a linen conveyer or other receptacle from which they are passed to the drying room.

The die of press is the most essential structural component of the system since it imparts a definite shape to the dough. If the powder is to be shaped into flakes or strips, a die with a mouth in the shape of a slot or several slots is used. E.g. German rifle powder was extruded in the form of strips 2 mm wide and 0.45–0.55 mm thick. The thickness of strips was modified by the change of die depending on the required time of burning of the powder. On changing the lot of nitrocellulose used for the manufacture of the powder, the experimental batch may indicate that it is more, or less, "vivacious" than the standard powder. To obtain a faster burning powder than that of the experimental batch made of strips, e.g. 0.50 mm thick, a die giving thinner strips, e.g. 0.45–0.47 mm thick is used. If, on the other hand, the experimental batch has too high a "coefficient of vivacity", the die should be replaced by one which gives thicker strips, e.g. 0.53–0.55 mm.

The influence of the web thickness on the ballistic properties of cannon powder is illustrated by the following example of strip powder used for 105–120 mm field guns. The total solubility of this powder is 35%.

Web thickness	Muzzle velocity obtained v_0	Pressure p
2.7 mm	733.5 m/sec	2563 kg/cm ²
2.8 mm	724.2 m/sec	2323 kg/cm ²
2.9 mm	719.0 m/sec	2282 kg/cm ²

With thinner powders the influence of changes in web thickness is greater. E.g. for the powder used for 75 mm field guns:

Web thickness	v_0	p
1.2 mm	547.5 m/sec	3015 kg/cm ²
1.3 mm	538 m/sec	2587 kg/cm ²

The final web thickness of flake and tubular powders, after the removal of solvent, amounts to 53–65% of the web thickness of the strip at the moment of extrusion. The extent of shrinkage depends on such factors as total solubility, the viscosity of nitrocellulose, the quantity of solvent and the composition of the dough at the moment of extrusion. A greater solubility and a higher content of solvent lead to greater shrinkage of the strip.

The die in which tubular powder is extruded is shown in Fig. 214 (according to Yegorov [11]). It consists of two sections (1) and (2) inserted one in the other. The

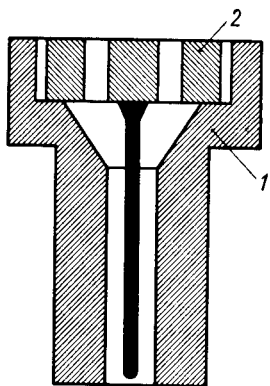

FIG. 214. Design for a die for shaping tubular powder.

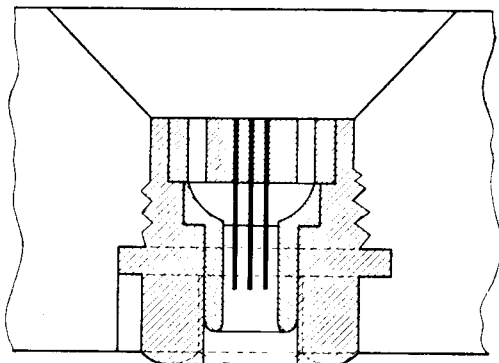

FIG. 215. Design for a die for shaping multi-tubular powder.

lower channel of section (1) of the die gives the outer diameter to the tube while section (2) of the die contains a centrally-fixed steel wire, the thickness of which determines the inner diameter of the single-perforated tube. Multiperforated dies are of similar design (Figs. 215 and 216, according to Yegorov).

The presses are usually operated with two cylinders working alternately. When the dough is extruded from one of them the other is loaded with material from the kneaders and vice versa (Fig. 217). The dough is loaded in batches, using a brass shovel, together with a ramming piston working under a pressure of about 50 kg/cm². A cylinder may hold 15–25 kg of dough (calculated as dry nitrocellulose) depending on the dimensions of the press. When the cylinder is loaded, a dried cake of dough and a leather disk are put over the charge as a seal to prevent the “leakage” of the mass through the gap near the pressing piston. As a cylinder is loaded it is turned through 180° to take up the position at which the piston, working under a pressure of 75–125 kg/cm², extrudes the mass through the die.

There are presses in which a cylinder fitted with a die and a system of filters is filled with the dough and turned through by 180°. In other presses, e.g. those of the Champigneul type, the bottom of the cylinder, when filled with the rammer, is formed by a separate piston. When, however, the cylinder takes up the position

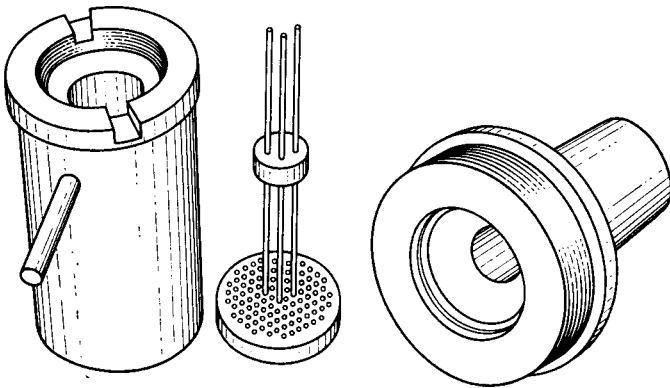

FIG. 216. A view of a multiperforated die.

for pressing the bottom section is formed of a set of filters together with the die. In turning the cylinder from the loading to the pressing position, only the cylinder is moved, while the bottom stays in position. A general view of a press of the Cham-

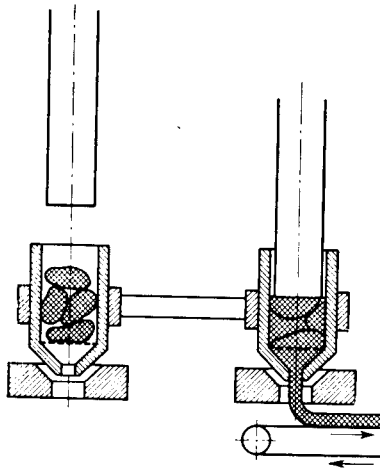

FIG. 217. Schematic view of the functioning of a press for extruding strips and tubes of powder.

pigneul type used in France and Werner-Pfleiderer used in Germany is shown in Figs. 218 and 219, respectively. Figure 220 shows a hydraulic press used in Sweden (Bofors Nobelkrut).

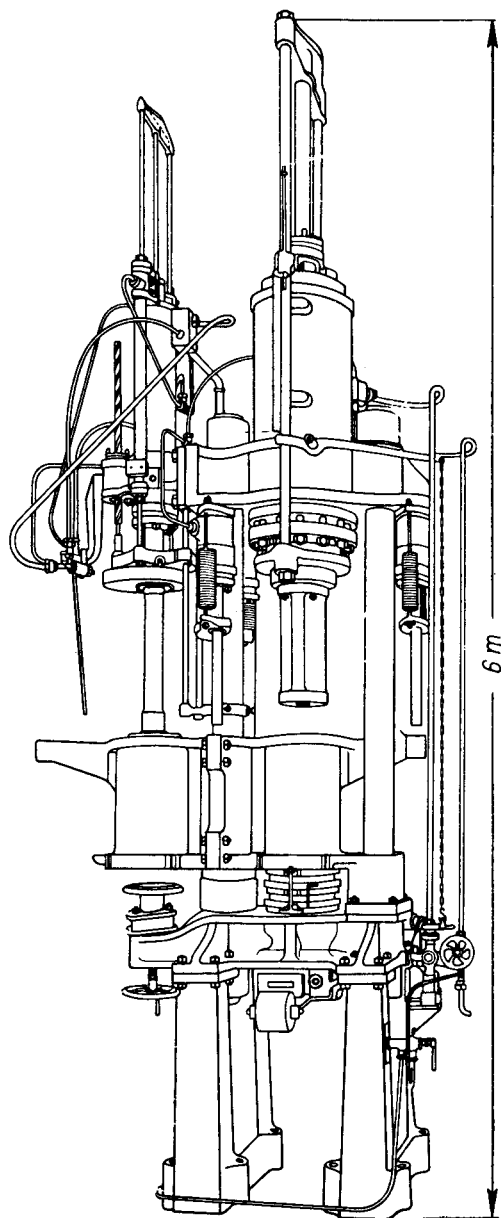

FIG. 218. General view of a Champigneul press used in France for extruding strips and tubes of powder, according to [13].

A horizontal extrusion press used in the U.S.A. is shown on Fig. 221.

The yield of a press depends not only on its design, applied pressure and the dimensions of the extruded strip or tube, but also on the plasticity of the dough. The effect of the dimensions of a strip or tube on the yield of the press is illustrated by the following examples. In a press of the Champigneul type, when pressing a strip 0.70 mm thick for rifle powder (total solubility 30%, amount of solvent 120%), the yield is 90 kg/hr. When pressing a strip 2.8 mm thick (total solubility 40%,

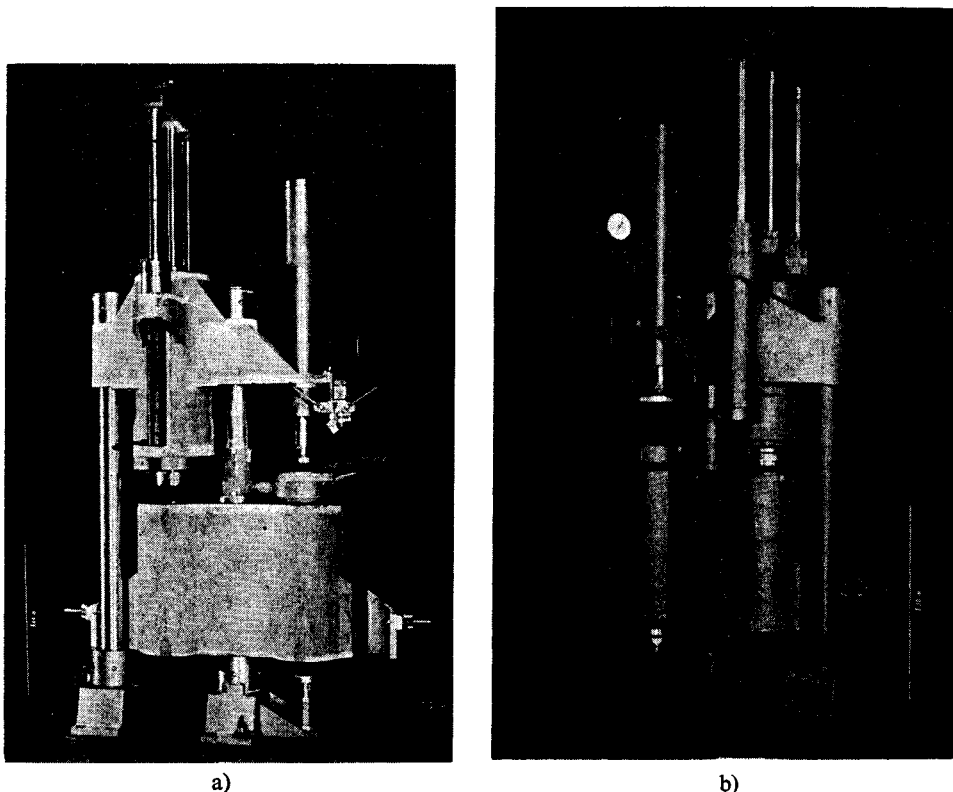

FIG. 219. General view of Werner-Pfleiderer powder press (Courtesy Werner & Pfleiderer, Maschinenfabriken und Ofenbau, Stuttgart).

amount of solvent 125%) the yield is 175 kg/hr (calculated as dry nitrocellulose). The same powder mass, when pressed into strips 5.0 mm thick, gives a yield of 200 kg/hr.

Pressing is not a particularly dangerous operation. Its safety is secured to a great extent by care in ramming the dough in the cylinder, so as not to leave free spaces filled with air. If this is not done an explosive mixture of solvent vapour in air is formed in these spaces and violent (adiabatic) compression of such a gaseous mixtures under the pressure of the piston may occur together, elevating the temperature above that of initiation. This could lead to an explosion. As previously stated, nitrocellulose containing solvent explodes with difficulty, thus there is no

danger that the explosion of a vapour-air mixture may bring about an explosion of the whole nitrocellulose mass. Nevertheless it does mean that there may be an explosion of a mixture of air with ether and alcohol present in the pressing room. This would have disastrous consequences.

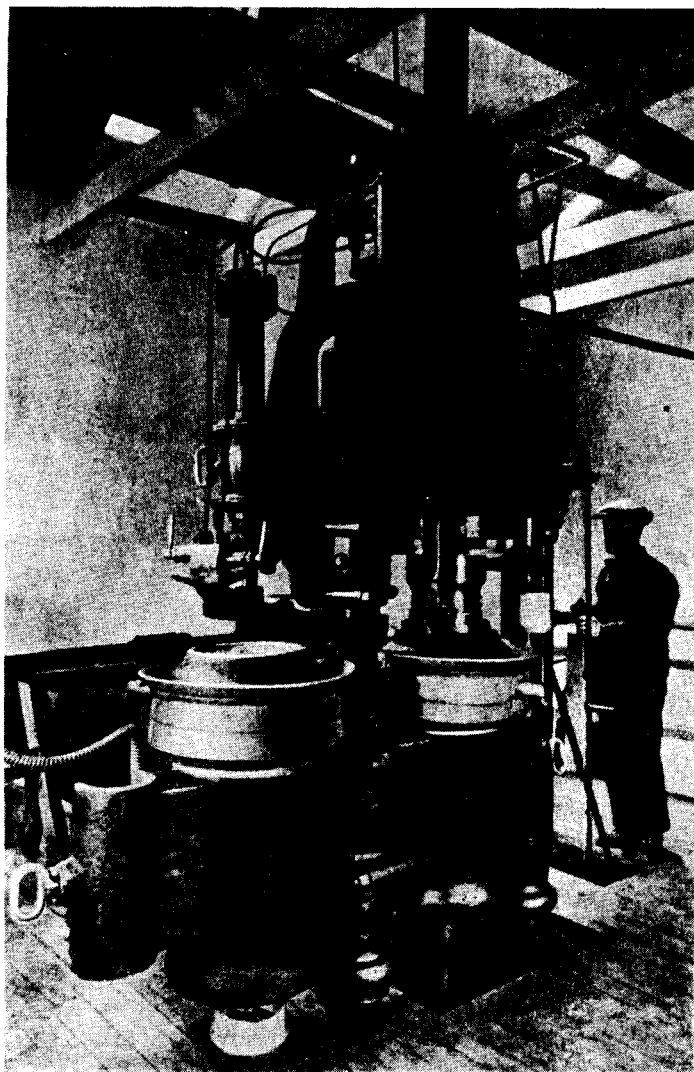

FIG. 220. Extrusion press used in Sweden (Bofors Nobelkrut).

Predrying

After the dough has been shaped, it is subjected to predrying which reduces the solvent content to 20–30%. The mass so dried becomes mechanically resistant and may therefore be cut without being deformed. Due to the presence of residual

solvent the mass also retains a certain plasticity and elasticity, preventing crumbling and dusting during cutting.

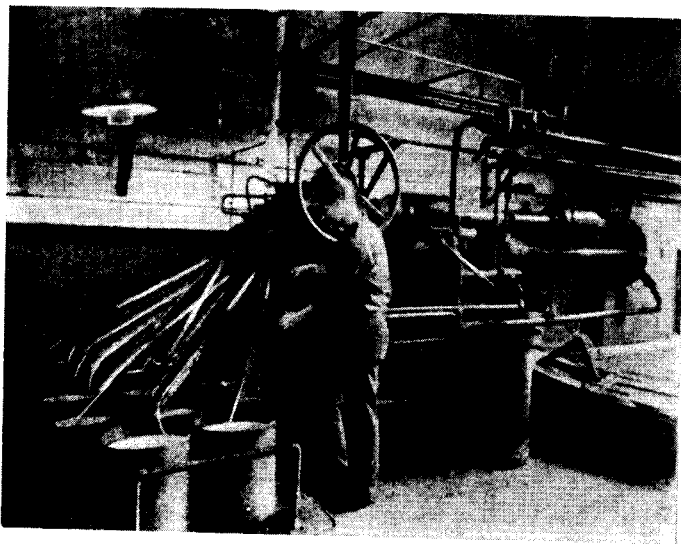

FIG. 221. Extrusion of powder in the form of perforated cylinders at E. I. du Pont de Nemours and Co. Factory, according to Davis [12].

Predrying should be conducted at temperatures as low as possible, i.e. within the range 15–25°C. Higher drying temperatures may cause the powder to swell or crack, due to intensive evaporation of solvent. It is therefore advisable, especially at the beginning, to maintain a low, but not too low temperature—in the latter case water vapour may condense on the powder, leading to the partial precipitation of nitrocellulose from the colloidal sol. This causes bright stains to appear on the surface of the powder. Since the heat of evaporation of the solvent is high, the temperature of the air coming into the drying room should be higher than the drying temperature. The composition of the residual solvent gradually changes. Ether, being more volatile, evaporates more quickly, so that the residual solvent is enriched in alcohol. A small quantity of ether remains in the alcohol, however, and is not removed by simple drying.

Since the rate of volatilization decreases as the ether is removed, the temperature should be raised gradually during drying.

An important factor influencing the dimensions of the predried powder is the viscosity of the nitrocellulose solution. The lower the viscosity of the nitrocellulose, the greater is the shrinkage of the nitrocellulose gel on drying. This produces flakes or tubes of considerably smaller size than those from nitrocellulose of higher viscosity.

Solvent recovery is extremely important from the economic point of view. The solvents are recovered by various methods, dealt with in a separate section (p. 599). From the time the strips or tubes are extruded until they are loaded into the predriers a certain period of time elapses depending upon the type of plant, the method of operation etc.

The amount of solvent escaping into the air depends on this period of time and on the season, the temperature of the air etc. Solvent losses range from 10–25%, calculated as the solvent introduced into the powder mass in the kneaders.

Originally, predrying was conducted in ordinary cabinet driers fitted with racks. Strips or tubes intended for drying were thrown over the racks. This type of drier

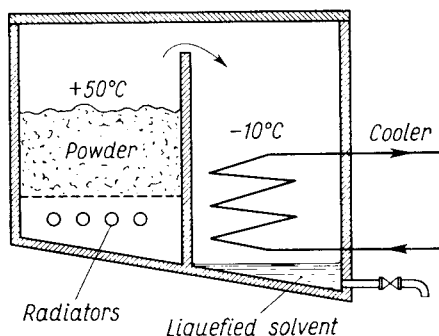

FIG. 222. A cabinet drier for predrying powder and solvent recovery.

is however unsuitable for the recovery of solvents since the relatively large surface of the door allows considerable solvent loss on loading and unloading. The cabinet drier used in the U.S.A. is shown in Fig. 222. Here the powder was placed in the

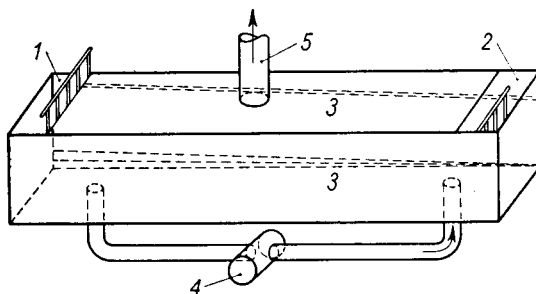

FIG. 223. A cabinet drier for predrying powder: 1—hole for loading, 2—hole for unloading the powder strips and tubes, 3—rails inclined towards the hole unloading, 4—air supply, 5—air exit.

drier already cut up since the method of manufacture required that thicker powder tubes must be cut up directly after pressing (before predrying). In some driers of more modern design used in France the surface of the loading and unloading holes is very small in comparison with the drier's capacity (Fig. 223). There are slightly

inclined rails inside the cabinet, on which the racks in the form of rods fitted with rolls, are moved. The powder strips, tubes or cords are suspended on the racks. Fresh air or air with a reduced content of solvent (depending on the recovery method) enters from the bottom, becomes saturated with the solvent, and escapes through the top. It is most important that the powder is dried as uniformly as possible. Driers of this design should not be too long as this prevents uniformity of drying. The best length is approximately 5 m.

Solvent recovery

Solvent escapes from nitrocellulose powder at various stages of its manufacture. The largest amount volatilizes during the predrying of the freshly shaped strips or tubes in cabinet driers specially constructed for this purpose. Installations for the recovery of this solvent have therefore long been in use in factories.

At other stages of the manufacture of the powder the solvent escapes into the atmosphere.

The losses of solvent in various stages of manufacture, for each 100 kg of nitrocellulose used (based on French findings from World War I) are tabulated below. Losses of alcohol and ether are calculated as alcohol (1 kg of ether equivalent to 1.4 kg of alcohol).

TABLE 178
LOSSES OF ALCOHOL AND ETHER IN THE MANUFACTURE OF NITROCELLULOSE
POWDER

No.	Stage of manufacture	Losses of alcohol kg
1	Dehydration	1
2	Kneading	5
3	Loading of presses	5
4	Pressing (for strips 1.8 mm thick on the average)	22
5	Loading and unloading of predriers	9
6	Cutting	7
7	Screening	10.8
8	Soaking	7
9	Refining of alcohol from dehydration	1
10	Refining of alcohol and ether recovered on predrying	7
11	Storing of alcohol and ether	1.2
	Total	76.0 kg

This summary gives the amounts of solvent that escape to the atmosphere of the factory premises at various stages of manufacture. This solvent is partly recovered by means of an additional installation which will be discussed later.

There are two essential methods for the recovery of solvent:

(1) Methods that rely on condensation of the solvent vapours by cooling (or compression).

(2) Methods relying on adsorption or absorption of the solvent.

Condensation methods are successful only when there is a high concentration of solvent vapours in the air. In practice, however, the concentration of the solvent in the air is usually not high enough, so that the efficiency of the installation is relatively low. When the vapours of solvent are considerably diluted in the air, the condensation method cannot be applied and the solvent should therefore be recovered by absorption.

Installations for the recovery of solvent usually consist of main and ancillary sections. The main installation comprises equipment for the recovery of the solvent which escapes from the powder on predrying. The ancillary installation recovers solvent from various production departments. Solvent recovery ducting is installed in rooms containing high solvent concentration. This improves the working conditions by removing ether-alcohol vapours from the atmosphere.

The main installation may be used for the recovery of solvent either by condensation or by absorption. The ancillary installation usually deals with considerably dilute solvent vapours so that the best results are attained by absorption.

Condensation or absorption methods may also be applied to the recovery of the solvent removed from the powder on drying under reduced pressure (p. 614).

The recovery of solvent from the water after soaking the powder and from the vapours evolved on soaking is a separate problem and will be dealt in a section on p. 620.

With more recent solvent recovery methods the consumption of alcohol and

TABLE 179
RECOVERY AND CONSUMPTION OF SOLVENT PER 100 kg OF
POWDER READY FOR USE

No.		Solvent (kg)	
		Used	Recovered
1	<i>Ether</i>	92-116	—
	Recovered in installations for predrying	—	44-63
	2 Recovered after the soaking of powder	—	—
	3 Recovered with cresol or activated coal	—	1-9
4	Consumption	39-56	
1	<i>Alcohol</i>	97-148	—
	Dehydration	—	26-75
	2 Recovered in installations for predrying	—	29-35
	3 Recovered after the soaking of powder	—	15
	4 Recovered with cresol or activated coal	—	1-3
5	Consumption	18-40	

ether in powder manufacture is considerably reduced. In Table 179 figures based on statistical data from various French factories during World War I are summarized.

The consumption of alcohol (1 kg of ether equivalent to 1.4 kg of alcohol) for the production of 100 kg of powder is 72–117 kg.

In choosing a method for the recovery of solvent operational safety is a primary factor to be taken into account. While the machinery is in operation the greatest danger is associated with the mixture of air and alcohol-ether vapour which flows through the pipelines and appears in various parts of the plant.

As moderate concentrations of solvent in the air, i.e. 4–9% are the most dangerous, danger is minimized either by very high concentrations (over 9%) or by very low ones (under 4%). Very high concentrations are only likely to occur in the main installation. There is always a danger, however, that with the predrying of the powder and the condensation of the solvent, the concentration of solvent vapours may fall to a limit at which the gaseous mixture becomes dangerous. The mixture of solvent vapours may also become diluted to the danger limit due to a plant leakage. For these reasons installations which require high concentrations should be considered relatively dangerous. Those which can work on low concentrations of solvent vapours, i.e. considerably below the lower limit of dangerous concentrations (i.e. installations for the recovery of solvent by absorption) permit a greater margin of safety.

Installations for the additional recovery of solvent are an additional hazard in a powder factory, because separate buildings, often some distant apart, are connected by pipelines through which a mixture of air and alcohol-ether vapour flows. This contradicts the basic rule that all buildings in a powder factory should be separate and at a safe distance from each other. There are devices for breaking a flame moving along a pipeline, but their effectiveness is limited, e.g. when weak explosions occur in the gaseous mixture (the design of these fire breakers is discussed on p. 607).

Instances are known of the destruction of nearly whole factories simply due to the fact that the separate buildings were connected with a net of solvent recovery pipelines, e.g. the large explosion at Hasloch, Germany, in 1926.

A method which might ensure safety in the recovery system is based on a partial or total replacement of the air within the pipelines by a gas containing no oxygen that does not form explosive mixtures with alcohol-ether, e.g. by nitrogen or carbon dioxide from exhaust gases. This method, however, proved too expensive, and was not carried beyond small scale tests.

Recovery of solvent by the condensation of vapours. This is one of the oldest methods which once was widely used in many countries (France, U.S.A.) and well checked in practice.

The recovery devices used in France (Fig. 224) function in the following way. Fan (2) forces the air, heated in heater (1), into the predrying chamber (3). The air in the chamber is saturated with the solvent up to a content of approximately 700 g/m³ (in percentage by volume this amounts to about 30% for alcohol and to

about 20% for ether). From there it passes through heat exchanger (4) into cooling chamber (5), where a temperature of -5°C is maintained. Here part of the solvent is condensed and flows down along the sloping bottom of the chamber. The air leaving the chamber contains about 300 g/m^3 of solvent. It then passes through the heat exchanger in which it is preheated to a temperature of $15\text{--}30^{\circ}\text{C}$ (depending on the method used for predrying the powder) and returned to the predrying chamber. Thus the air circulation cycle is a closed one.

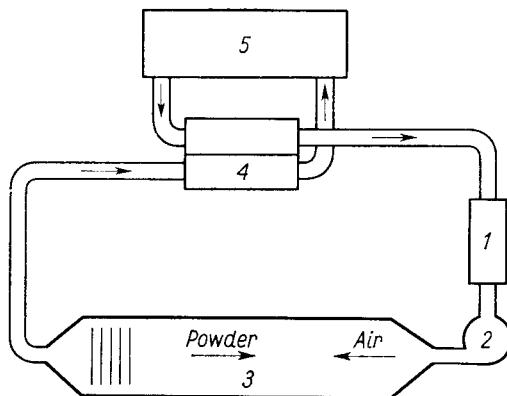

FIG. 224. Schematic view of an installation for predrying powder and solvent recovery, according to [13].

Recovery stops when the content of solvent in the air in the predrying chamber drops to 10%.

In the installation described above 80–85 kg of liquid solvent is recovered per 100 kg of powder (calculated as dry nitrocellulose). Accepting that before predrying the powder contains 110–115% of solvent and after it, 15–25%, the amount of recovered liquid represents 80–90% of the solvent lost by the powder on predrying. This accounts for 60–70% of the solvent used for the manufacture of the powder. Since the recovered liquid contains about 5% of water, its amount is somewhat lower.

The average composition of the recovered liquid is:

Ether	62%
Alcohol	33%
Water	5%

The composition of the liquid varies depending on the temperature inside the predrier (at the beginning it is 10° , by the end 30°C). At a high temperature (e.g. 50°C) the content of water in the liquid is less than 3%.

The composition of the recovered liquid also varies in time. At the beginning the liquid is rich in ether (60–70%) and relatively poor in alcohol (about 30%). By the end alcohol predominates (about 70%), and the content of ether falls to about 25%. The content of water remains almost constant.

The operational safety of this recovery installation is far from perfect. Explosions in driers caused by the impact of steel or even brass tools against iron, by the friction of powder strips against the iron edge of driers or by the electrification of powder strips, are well known.

Recovery of solvent by isothermal compression. This method was proposed by Claude [14]. It was applied to the recovery of alcohol containing camphor which escapes during the manufacture of celluloid. With alcohol and ether this process entails compressing the vapours to 7 atm, thus causing the condensation of the alcohol and after that rapidly expanding them. Ether is condensed by intensive cooling. The necessary plant was very expensive and there was risk of explosion when the mixture of the air with alcohol and ether was compressed too rapidly. It never attained wide application.

Absorption of solvent with sulphuric acid. This is another of the oldest methods for the recovery of solvent. It was first used for the recovery of alcohol and ether in the manufacture of artificial silk by the old Chardonnet process and was then widely applied in the manufacture of powder in Germany and Austria before and during World War I. The air containing alcohol and ether entered the tanks filled with sulphuric acid. The tanks were cooled from outside by spraying with water.

At the Troisdorf powder factory near Cologne, lead towers sprayed inside with sulphuric acid were used for the absorption of the solvent. Air containing alcohol and ether entered from below in counter-current to the sulphuric acid.

The solvents were distilled from the sulphuric acid by heating to 120°C. Alcohol is then partly converted into ether. The yield was low: only 10–12% of solvent used for the manufacture of the powder was recovered. The disadvantages of this method were numerous and the method is no more in use.

Absorption of solvent with cresol. During World War I Brégeat [15] in France suggested the recovery of alcohol and ether with cresol. After successful tests in 1917, installations for solvent recovery by this method were erected in all the powder factories in France. The installations for ducting the air containing solvent were so arranged that they were in operation during unloading of the kneaders, loading of the presses, extrusion of the powder strips in the presses, and the loading and unloading of predriers.

The method is based on the fact that with alcohol and ether cresol forms a molecular compound which may then be decomposed by heating to a temperature of 130–135°C. The absorption is conducted in towers sprayed with cresol. The air and solvent vapour enters the towers from below. The towers are filled with ceramic rings. A diagrammatic view of the installation is shown in Fig. 225. Air plus solvent is introduced from below into tower (1), sprayed with cresol containing alcohol and ether. Partly freed from solvent, the air enters tower (2), sprayed with fresh cresol pumped from container (4). Tower (3) serves for recovering the drops of cresol entrained by the air. Cresol containing alcohol and ether flowing down from tower (2) is pumped by pump (5) into tower (1), from which, through pump (6) and container (7), it is passed to the heat exchanger (8) and the retort (9), in which

alcohol and ether are distilled off. When free from solvent it flows down through the heat exchanger (8) and is returned to container (4).

Solvent absorption using cresol gives a good recovery yield, but large quantities of cresol are required. This is a drawback, and so is the costly installation required.

The recovery of alcohol and ether by the Brégeat method was used in Great Britain at Gretna during World War I, and was later adopted in Belgium at Caulilles and in Germany at Hasloch.

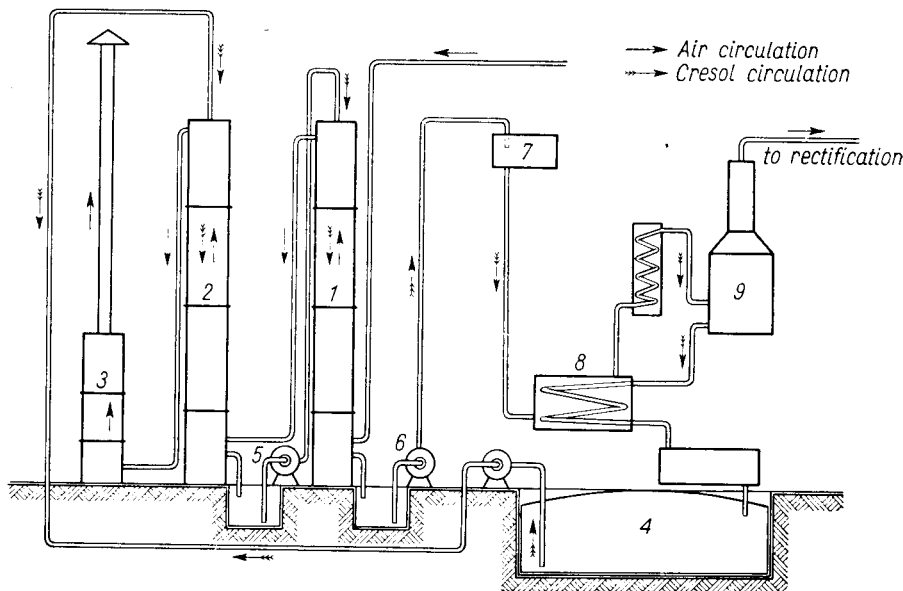

FIG. 225. Schematic view of an installation for the absorption of solvent with cresol (Brégeat method).

Absorption of solvent using water and aqueous solutions. This method, though of no value for alcohol and ether, was used for the recovery of acetone in cordite manufacture in Great Britain. Acetone was also recovered by using a solution of sodium hydrogen sulphite.

Adsorption of solvent on silica gel. Attempts to use this adsorbent failed since activated silica adsorbs moisture from air more strongly than alcohol and ether vapour.

Adsorption of solvent with activated charcoal. This is the most modern method of solvent recovery. It was introduced after World War I and immediately attracted attention by the exceptionally high recovery obtained, amounting to approximately 98% of the solvent entering the plant. The first plants using activated charcoal were used extensively in the oil industry for separating methane from heavier fractions in natural gas.

Initially, adsorption with charcoal was not efficient when used as a main installation in nitrocellulose powder factories. With the high concentration of alcohol and

ether in the air the charcoal became very hot during adsorption, and this often led to an outbreak of fire in the adsorber. However, the safety of the operation was considerably higher when this method was applied to ancillary recovery. When working with dilute mixtures of alcohol and ether in air, there was less risk of fire and the yield of solvent recovered was increased. A concentration of solvent of less than 15 g/m^3 of the air (below 1%) is now common.

This method is applicable both for ancillary and main recovery. For the latter, however, a closed cycle is avoided by introducing large amounts of fresh air into the driers, as a diluent.

The simplest device for the adsorption of solvent on charcoal is shown in Fig. 226. The air containing alcohol and ether is introduced from below through valve (1) into a cylindrical container (adsorber) filled with activated charcoal. Alcohol and ether are adsorbed on the charcoal and the solvent-free air escapes through

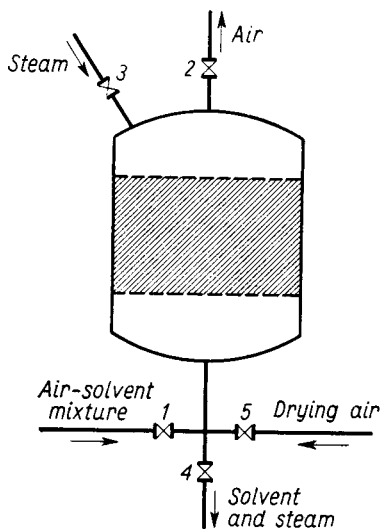

FIG. 226. Schematic view of an activated charcoal adsorber.

valve (2). The heat of adsorption raises the temperature of the charcoal by $30\text{--}40^\circ\text{C}$ above ambient temperature. When the activated charcoal approaches saturation, the air-solvent mixture is directed to another adsorber. (It takes 5-7 hr to saturate an adsorber, depending on the concentration of solvent in the air.) Valves (1) and (2) are then closed, valve (4) is opened, and steam is introduced through valve (3) to remove the adsorbed solvent. Solvent and steam escape from the container through aperture (4). After the solvent has been removed, the inflow of steam is stopped, valve (4) is closed and hot air (110°C) is introduced through valve (5). This desiccates the layer of charcoal and air charged with water vapour escapes through valve (2). The evaporation of water from the charcoal during drying leads to a drop in temperature of the charcoal to 100°C or lower. The end of drying is indicated by

a sudden rise of temperature to 110°C. This is a moment of great danger when the charcoal may ignite. To prevent this, carbon dioxide or nitrogen may be introduced into the container towards the end of drying, which may take 6–8 hr (the time is variable and depends on the operating conditions). When drying is completed the inflow of hot air is replaced by one of cold air. Cooling is completed when the temperature falls to 15–20°C, which takes 1–2 hr depending on the season. After the adsorbent has been dried and cooled, the container is ready for the next adsorption cycle.

One adsorber holds a charge of charcoal ranging from 500 to 2000 kg, depending on the dimensions of the charcoal grains. A complete adsorption cycle comprising adsorption, distillation, drying and cooling lasts 14–18 hr.

3000 kg of steam, 0.08 m³ of water and 0.2 kWh of current are required per 100 kg of solvent recovered. The consumption of activated charcoal (to replace losses due to collapse of the grains or loss of activity) is calculated at 0.05 kg per 100 kg of the solvent recovered.

The large steam consumption acted as an incentive to the development of another and more economic process. In the "Acticarbone" method developed in France between 1925–1926, the heater-cooler was located inside the adsorber, so that heating and cooling the charge was much more economical. In this installation 300 kg of steam was consumed for each 100 kg of the solvent recovered.

However, this system was abandoned because location of the steam heater inside the adsorber was not sufficiently safe. The modified system now most widely used is described below.

Efficiency and safety were improved by changes in design. A schematic view of a more modern "Acticarbone" installation is shown in Fig. 227. The time for each operation in this installation is considerably less than in earlier designs, i.e.:

Adsorption	2 hr
Steam distillation of solvent	$\frac{3}{4}$ hr
Drying the charcoal with hot air	$\frac{3}{4}$ hr
Cooling	$\frac{1}{2}$ hr

In addition to the charge of activated charcoal *A*, a "thermal" layer *T* of broken rock is laid in the adsorber to absorb heat should the charcoal layer ignite. The air plus solvent passes through fan *V*, valve (1), layers *T*, *A* and valve (2). When the charcoal is saturated with solvent both valves are closed, the steam is introduced through valve (3), valve (4) is opened and the alcohol and ether are distilled off and passed to the condenser (5). The condensed solvent and water is collected in the lower section (6), and from there conveyed by pump (7) for rectification. After the solvent has been distilled the inflow of steam is stopped and hot air is passed through the adsorber, with valves (1) and (2) open. When the charcoal is dry the air heater is shut off (it is not shown in the figure) and the charge is cooled by means of cold water, after which the adsorber is ready for another adsorption cycle.

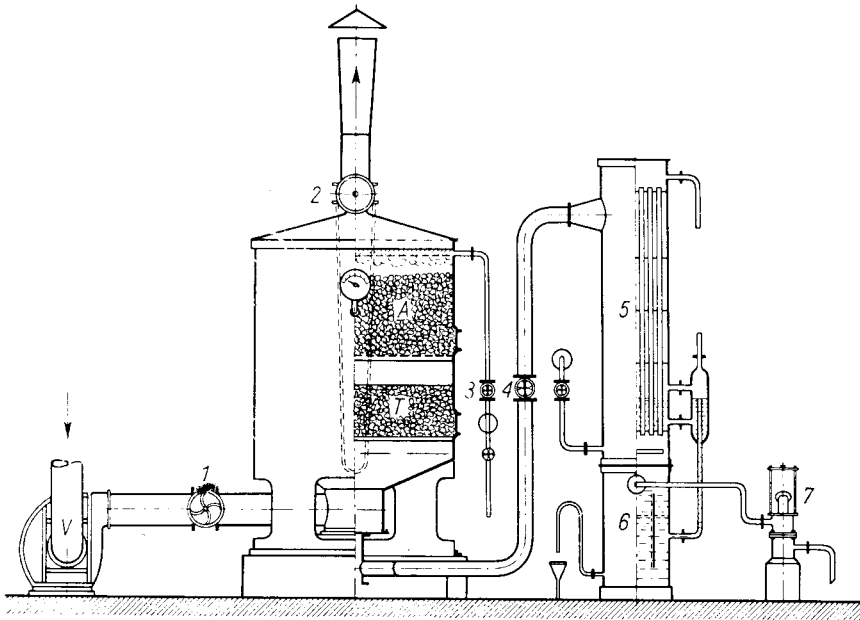

FIG. 227. Schematic view of an installation for the adsorption of solvent vapours (alcohol and ether) with activated charcoal by the "Acticarbone" method.

Fire breakers are used to protect the installation against flame that may arise in the pipelines carrying an inflammable mixture of air and ether-alcohol vapour and to cut off the drier from the pipelines that serve it. Breakers of the Sudlitz [16] type (Fig. 228) have proved the most efficient. In Sudlitz's opinion, the efficiency of the breaker is high if there is a partition in box (1), permitting easy passage of

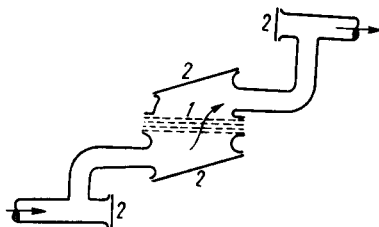

FIG. 228. Schematic view of a Sudlitz fire breaker.

the gas and filled with heat-conducting metal. Copper mesh is used to form the partition and spirals, rings or copper shot are used as the filling. The box and pipeline outlets are closed with lids of thin sheet (2) so that they break if an explosion occurs in the pipeline. Any excess pressure leading to detonation of the gaseous mixture is thus avoided.

Cutting

In some countries (e.g. in the U.S.S.R. and in the U.S.A.) thick strips (for cannon powders) may be cut immediately after the extrusion of the tubes. This is possible only when pyrocollodion cotton is used for the manufacture of the powder since it is easily soluble and requires only a small amount of solvent (about 80% by weight of nitrocellulose). After cutting the powder is subjected to predrying. When

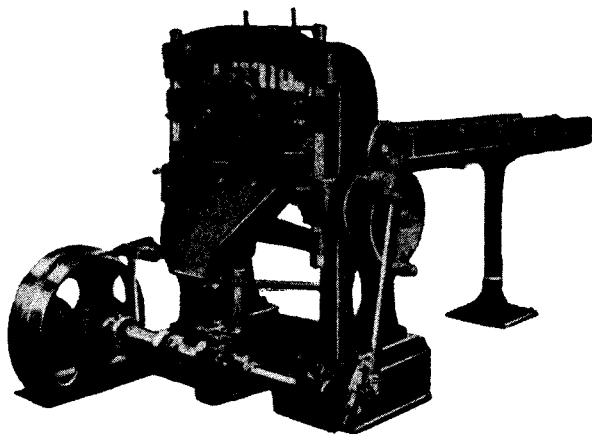

FIG. 229. A guillotine for cutting powder strips into flakes [7].

dried to a solvent content of 15–30%, the powder strips or tubes are usually sufficiently plastic and elastic to be cut without breaking or crumbling, caking or deforming.

The cutters are designed according to the required shape of the powder. For cutting the powder strips into square flakes “guillotines” are often used (Fig. 229), in which a bundle of strips is moved forward intermittently, driven by a mechanism synchronized with the knife of the guillotine. The length of the stroke of the driving mechanism can be varied within certain limits. The knives must be very sharp, and are therefore changed frequently (every 0.5 hr). This greatly influences the uniformity of the dimensions of the flakes which, in turn, affects the uniformity of the ballistic properties of the powder.

Similar guillotines are used for cutting powder tubes. For short tubes a guillotine of the design described above is used. Slightly different ones are used for cutting of long tubes which are usually moved under the knife by hand.

Cutters for cutting wide powder strips into square or rectangular flakes are of quite different design, the principle of which is shown in Fig. 230. They consist of two systems of knives. The first is composed of two rollers with rectangular knives of a width corresponding to the required width of the powder flakes. The strip is thus cut lengthwise into ribbons (Fig. 231).

The second system cuts the strips crosswise, i.e., at right angles to the first one, and consists of a fixed knife-edge against which two knife blades rotate.

In this system, which is used extensively in France, a frequent change of knife blades and repeated sharpening are indispensable in order to ensure uniform properties in the powder.

In some factories cutting is combined with rolling (smoothing) the powder strips, if the powder is to be shaped in strips or flakes. Special cutters are used for

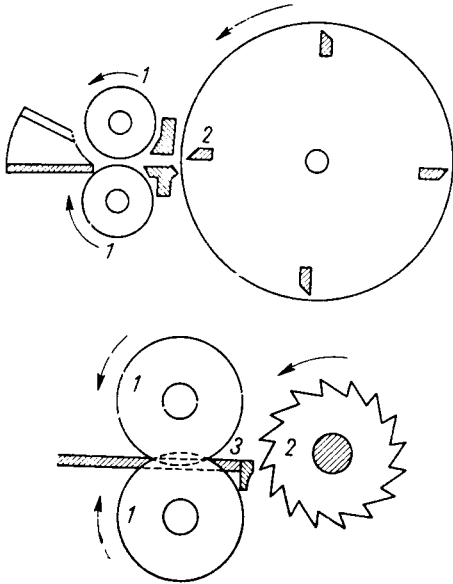

FIG. 230. A French design for cutters for wide powder strip, according to Vennin *et al.* [13]; 1—rollers cutting lengthwise; 2—rotational knife cutting crosswise; 3—fixed knife.

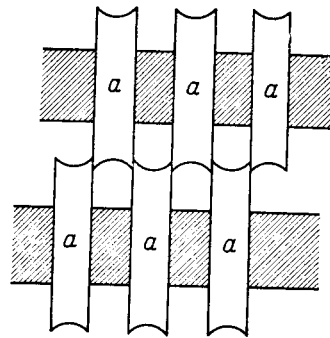

FIG. 231. A design for rollers cutting lengthwise, according to Vennin *et al.* [13]; a—cutting knives.

this purpose (Fig. 232). They are fitted with smoothing rollers (1) and cutting rollers (2). The rollers are clamped with screws (3). Smoothing considerably reduces the quantity of waste resulting from deformation of the powder strips on predrying.

Cutting is a fairly safe operation if the cutters are carefully earthed to prevent them from building up static electricity, which has been a frequent cause of accidents. Care also should be taken to prevent overheating of the cutter component, including the knives. If overheating occurs the cutter must be stopped for some time until the knives are cool.

Grading

After being cut the powder should be graded to remove irregularly-shaped flakes, strips or tubes. The quantity of waste depends on the shape of the powder, its dimensions and on the condition of the cutters. With flake rifle powders, for instance, the

smaller the dimensions of the powder flakes, the larger is the quantity of waste. The thicker the strips or tubes, as extruded from the press, the smaller the quantity of waste discarded during grading.

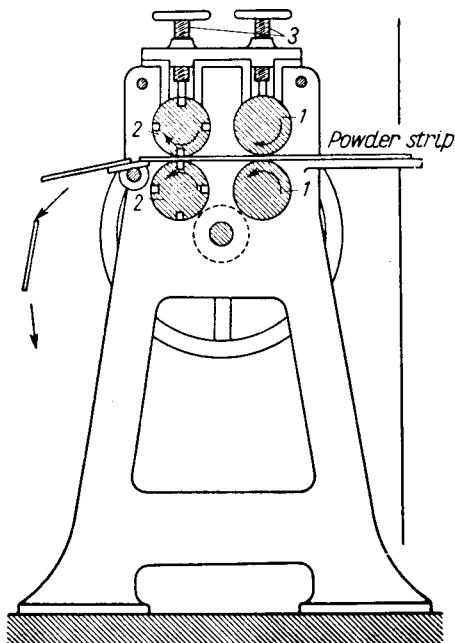

FIG. 232. A cutter for powder strips with smoothing and cutting rollers, according to Yegorov [11].

The method of grading depends on whether a fine-grained powder is to be dealt with or whether it is in the form of strips or long tubes. The former is graded mechanically, the latter manually.

Mechanical grading of fine-grained powder is carried out using vibrating or rotary screens of various designs (Figs. 233 and 234). Dust and oversized or irregular grains are collected in separate receivers together with undersized grains. The screen dimensions (usually made of brass gauze) are chosen in accordance with the type of powder being graded and the required dimensions of the grains. Waste and dust are recycled for processing (this will be discussed in the section devoted to the processing of waste—p. 631).

Manual grading consists of inspecting the strips or tubes and discarding those which are ill-shaped or discoloured (dark-blue stains). Grading is usually carried out on tables from which dust and waste are discarded into special boxes. It is advisable to use tables made of clouded glass lighted from below by electric light. This facilitates the recognition of defects in the powder (stains, wrong colour, etc.). Powder with dark stains is rejected into a separate box so as not to mix it with powder discarded because of faulty shape. The latter is recycled. Dark coloured powder is

considered unstable and is either destroyed or made into training or sporting powders which can be used without delay.

The output of manual grading depends on the dimensions of the strips and tubes, i.e. it is higher for larger dimensions of powder. When grading one of the finest

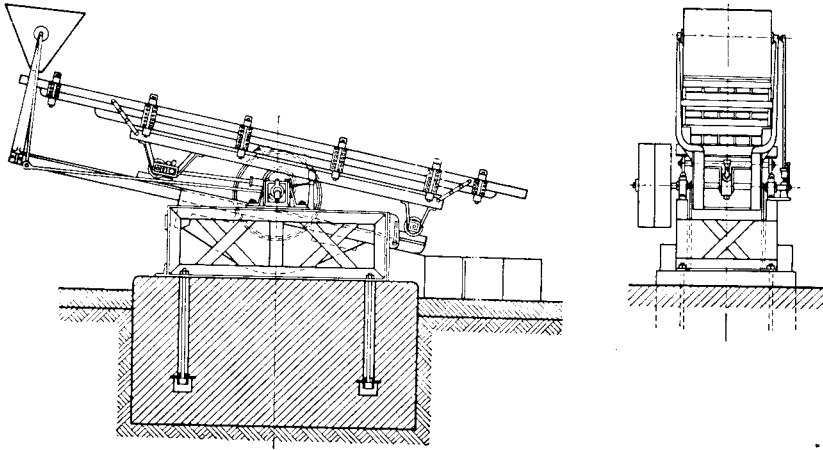

FIG. 233. Schematic view of an installation for the mechanical grading of fine-grain powder (vibrating screen), according to Yegorov [11].

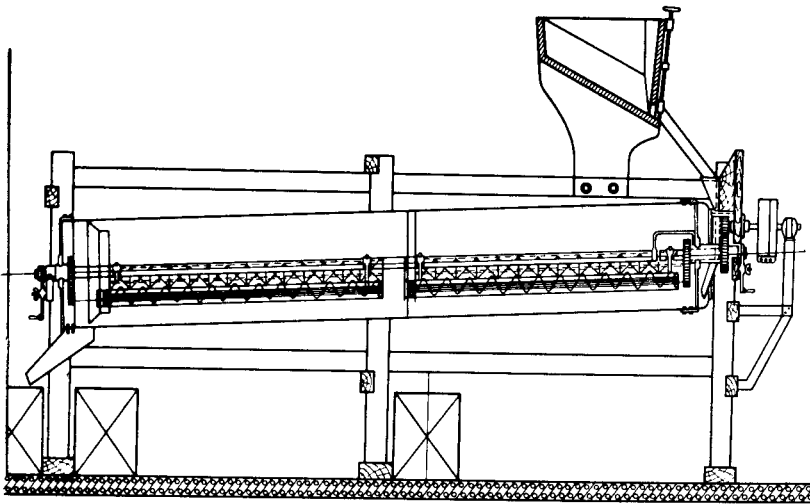

FIG. 234. Schematic view of a Marot installation for grading fine-grain powder (rotary screen), according to Yegorov [11].

types of strip powders (powder for 75 mm field gun), of dimensions $0.7 \times 20 \times 144$ mm, output is approximately 10 kg/hr per one worker.

Powder which is cut but neither air- nor water-dried is known as "green" powder.

Final removal of solvent

A predried powder burns very slowly since the residual solvent acts as an inhibitor. It is not until the content of residual solvent is reduced below a certain limit that the powder attains a usable rate of burning. It also acquires ballistic stability, so that its ballistic properties are unchanged during storage, since it contains no volatile constituents capable of volatilizing spontaneously and thus of modifying the ballistic properties.

The final removal of solvent from nitrocellulose powder may be carried out by two methods:

(1) By drying at reduced pressure at a temperature of 80°C or at atmospheric pressure at a temperature of 50–60°C.

(2) By soaking the powder in cold or hot water followed by drying.

Drying at reduced pressure. It was widely practised in Germany and often made it possible to avoid the soaking of powder. Driers used for this purpose (Fig. 235)

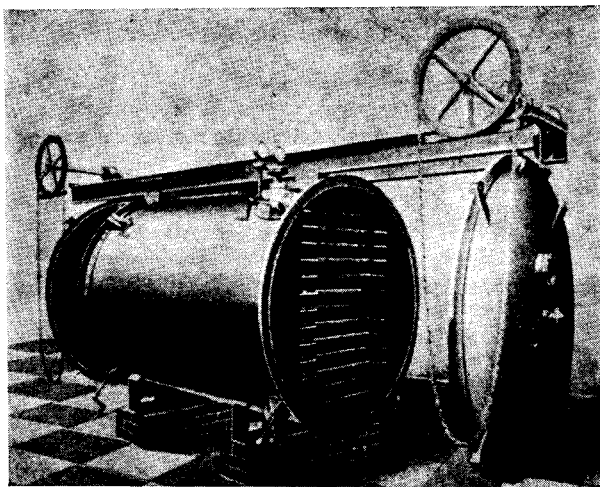

FIG. 235. A drier for drying nitrocellulose powder [7].

consist of a cylinder made of boiler iron and shelves heated with hot water to a temperature of 60–80°C. The cylinder is tightly closed on both sides with lids clamped down by means of screws.

The powder is spread on cotton muslin stretched over wooden frames and placed on the shelves. The drier is then closed and the vacuum pump set in motion. The pump usually operates at a pressure of 100–150 mm Hg. When the pressure becomes steady, the screws clamping the lids are released, but the lids continue to adhere hermetically to the drier, owing to the reduced pressure created inside. As a safety precaution the driers work in this manner until drying has been completed. Thus should ignition occur the lids are freely detached. This prevents the powder from burning in a confined space, and exploding, and so destroying the drier. The capacity of the

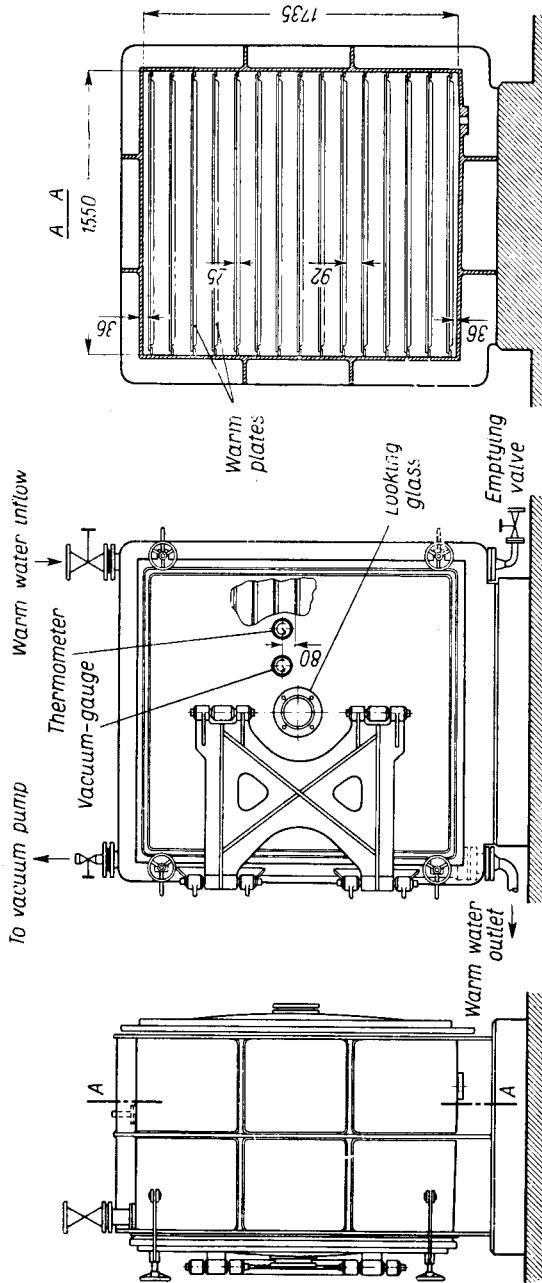

FIG. 236. View of a drying room with an installation for the recovery of solvent at reduced pressure.

drier is 1000–1200 kg of powder (calculated as the weight of dry nitrocellulose). Driers of this type are commonly used for the manufacture of fine-grained powder (e.g. rifle flake powder). Such a powder takes about 24 hr to dry at a temperature of 80°C. Powder dried at a reduced pressure has the advantage of being less porous than that from which the solvent is removed chiefly by soaking. After drying at reduced pressure, the powder may be subjected to soaking to remove residual solvent and then dried again. This treatment does not lead to the formation of additional pores in the grain. A more modern design of vacuum-drier is shown on Fig. 236.

An installation for the recovery of solvent (chiefly alcohol) by condensation is connected with a drier operating at a reduced pressure. The installation works at atmospheric pressure. It consists of two condensers cooled with cold water in which ether and alcohol (containing some water and ether) are condensed. From 10 to 25 kg of 95% alcohol is recovered per 100 kg of powder according to the season (more in winter).

Drying at atmospheric pressure. Various types of driers are used to dry powder at atmospheric pressure. In France drying houses with natural air circulation were often used (Fig. 237). They are reinforced concrete buildings with three stout walls and one—the blow-out wall—made of wood. The building is divided into several compartments each of which holds 600–1000 kg of powder for drying. The partition walls should be thick enough to withstand a high pressure in the event of ignition of the powder, so that only the light blow-out wall is wrecked. A door in the light wall is fitted with a reinforced concrete canopy to protect the drying house from rain and to direct the flame in the required direction should ignition of the powder occur. The canopy walls are of double thickness. There are openings with brass grids in the lower section of the light wall, above the canopy and in the door of the drying house. Air enters through the lower openings and escapes through the upper ones. The air is circulated as indicated by arrows through radiators heated with hot water [17]. They are located under iron shelves on which the trays of powder are set. The trays are made of wire netting stretched over wooden frames. When fine-grained powder is dried they are also covered with muslin. A separate chamber contains an automatic system for keeping the temperature of the water which feeds the radiators constant. This should be higher by 5°C than that inside the drying house and is usually 60°C (inside it is 55°C).

Drying at a temperature of 55°C requires at least 24 hr, but the actual duration depends primarily on the web thickness of the powder. As a guide the following interrelations may be assumed between the time of the drying of strip powder at 55°C and its web thickness:

Web thickness	Approximate time of drying
mm	hr
0.8–1.5	24
2.3–2.5	36
3.2–7.5	48

When drying has been completed the inflow of hot water to the radiators is stopped and the door is opened for 3 hr to cool the powder before unloading.

The drying house described above is very economical since it does not consume any mechanical energy. Its disadvantage lies in its rather poor air circulation which prolongs the drying process and therefore exposes the powder to the action of a high temperature for a relatively long period of time.

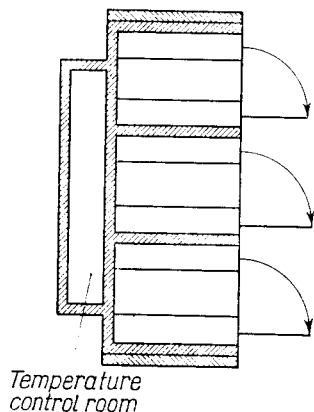
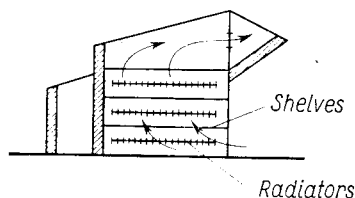

FIG. 237. Schematic view of a standard drying house for nitrocellulose powder used in France.

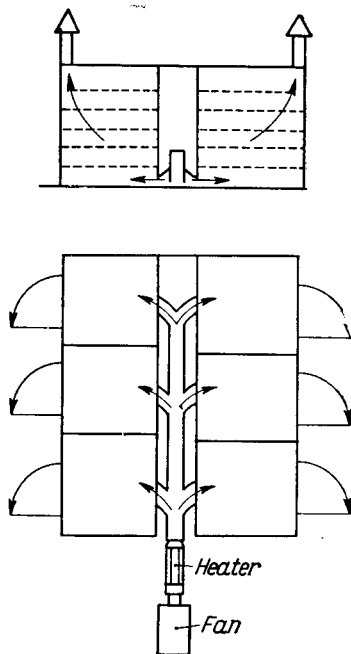

FIG. 238. Schematic view of a drying house with mechanical ventilation.

There exist a wide variety of drying houses with mechanical ventilation. Cabinet driers (Fig. 238) are one of the simplest types. In these the powder is spread on shelves through which there is a free passage of air. The air forced by means of a fan passes through a heater and is then supplied from below by pipelines to each partition of the drying house. The door opens from outside. The outer corridors (not shown in the figure) should be wide enough to allow for the passage of the trucks bringing the powder to be dried or removing it after drying.

There is another method (de Quinan method, Fig. 239) in which the powder is placed in shallow cylindrical (or otherwise shaped) tubs of brass sheet, lined internally with cloth. The bottom of the tubs are perforated. A fan forces heated air through the bottom; the air passes and escapes through an outlet in the roof of the building. When dry, the powder is cooled by cold compressed air. Drying in drying houses with mechanical ventilation takes approximately half the time needed when a natural

air stream is used. Drying with mechanical ventilation has the disadvantage that a strong stream of air favours the oxidation of the diphenylamine present in the powder, and thus may easily lead to dark coloration (dark-blue or dark-green).

The drying of powder was formerly one of the most hazardous operations, but since the causes of danger have been eliminated by new methods it is now no more dangerous than any other of the processes for manufacturing nitrocellulose powder. The following rules must always be observed:

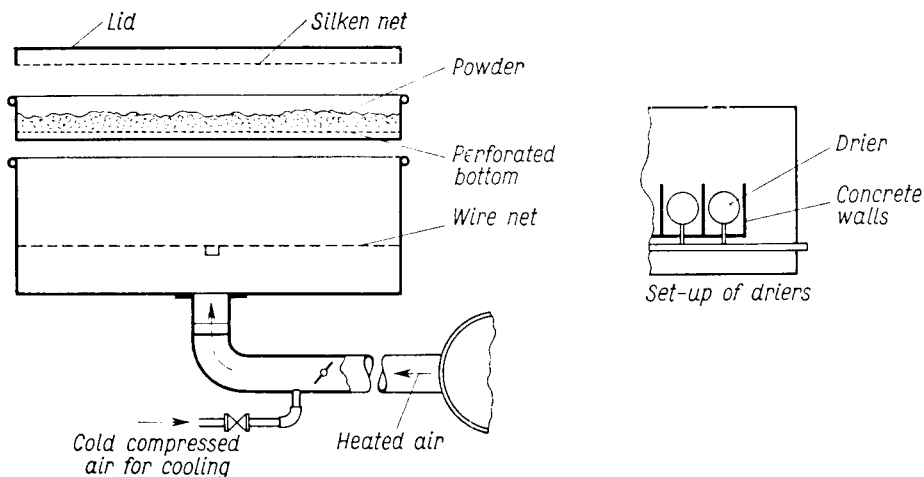

FIG. 239. Schematic view of a de Quinan drier.

- (1) All shelves and other metallic parts of drying houses should be earthed.
- (2) Doors in drying houses should be shut with clamps made of wood or of non-sparking metal.

(3) The premises must be kept clean with particular attention to the removal of spilt powder. Powder lying scattered on shelves or the floor for long periods undergoes spontaneous decomposition with the passage of years and has often been the cause of the ignition of powder in drying houses. Keeping the radiators clean is particularly important.

(4) The powder must not be removed from the drier until it has been cooled to a temperature of about 30°C.

Drying with infra-red radiation. The studies of Brun and Ratouis [18] show that drying with infra-red rays may reduce the time necessary for the removal of solvent by 20 or even 100 times, although for two reasons it is more expensive:

- (1) The heat supplied by infra-red radiation is more expensive (at least three times) than steam heating.
- (2) Only thin layers of powder may be dried since in thick layers the surface may acquire a dry skin, leaving a damp layer underneath. This may upset the uniformity of burning.

For the latter reason infra-red radiation is not used for drying nitrocellulose powder.

The design of an infra-red drier will be discussed later in the text (p. 636 and Figs. 254 and 255).

Soaking the powder. It appears that the final removal of solvent by soaking ("bathing") was first applied by Sukhinskii [19] in Russia, in 1892. By this method the solvent is removed from the powder much more rapidly than by any other. Soaking was widely practised in the manufacture of nitrocellulose powders during World War I, since it considerably accelerated production. The soaking temperature was then 80 or even 90°C which was inadvisable for three reasons:

(1) Due to the high temperature of the water some of the diphenylamine dissolves, thus reducing the content of stabilizer in the powder; in addition, the high temperature leads to more vigorous oxidation reactions of the diphenylamine.

(2) Due to the high temperature of the water the nitrocellulose partly coagulates from the colloidal state particularly on the surface.

(3) Powders become porous which is not always desirable.

A soaked powder may be easily distinguished from a non-soaked one. The latter retains a certain transparency while the former is dull, opaque (due to partial coagulation) and usually dark, of a grey-greenish colour, on account of the reactions undergone by the diphenylamine at a high temperature in the presence of water.

Soaking is most efficient if the powder has been only predried, but not dried at an elevated temperature. On drying at an elevated temperature (50–80°C) a dry skin forms on the surface of the powder, and this prevents the solvent inside from diffusing into the water. For these reasons it is most desirable to soak the predried powder at a low temperature (15–30°C) which is then gradually elevated to 50–60°C.

Vigorous prolonged soaking at a high temperature, like drying for a long period, may reduce the stability of the powder. It is believed that the decrease of stability is particularly pronounced when a non-dried powder, which contains a large amount of solvent, is subject to soaking. This may be attributed partly to the fact that on soaking a non-dried powder loses more diphenylamine than a dried powder containing little solvent.

Long detailed investigations have shown that if the powder is predried immediately after extrusion in a damp atmosphere facilitating moisture penetration its stability is impaired. If however drying takes place in a confined space by the action of a stream of dry air, without access of moisture, the stability is not reduced. In the latter case it makes no difference whether or not the powder is soaked after drying. With modern predrying equipment there is no fear of decreasing stability on soaking unless this is done too vigorously (soaking at a temperature of 90°C and over should be considered harmful, at a temperature of 80°C soaking should not exceed 72 hr).

Sometimes, when a highly porous powder is wanted (e.g. a sporting or training powder of high vivacity) the powder strips or cords are soaked in hot water immediately after extrusion from the press. A violent evaporation of solvent then ensues, the strips or cords swell, and holes are formed inside (Bazylewicz-Kniażykowski and

Partyka's method [20]). Powder may also be made porous by the previous introduction into the powder mass of salts soluble in water which are extracted by soaking. Potassium nitrate is generally used for this purpose so that a certain amount of it remains in the powder and enhances its vivacity.

The soaking of nitrocellulose powder in which alcohol and ether were used as a solvent should be carried out so that the solvent (chiefly alcohol) which passes into aqueous solution may be recovered. Nitroglycerine powder manufactured with a volatile solvent such as acetone should never be soaked since water would remove some of the nitroglycerine from the powder.

Soaking may often be replaced by drying at a reduced pressure, as previously discussed (Passburg [21]). This, however, requires expensive installations and is therefore relatively rarely used or only on a small scale.

Soaking is carried out either in cold, non-heated water at room temperature (15–30°C) or at an elevated temperature (50–80°C).

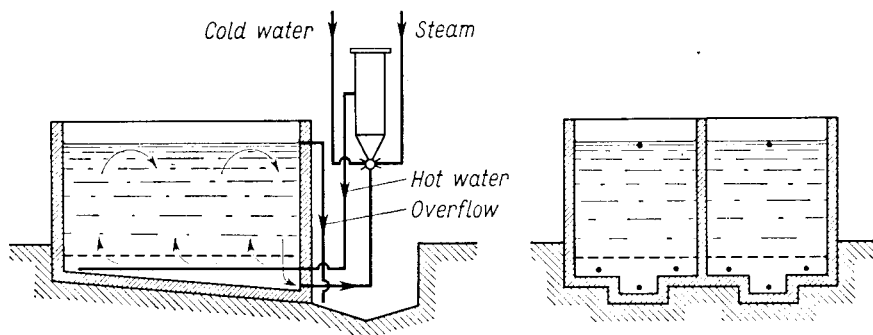

FIG. 240. A concrete basin for soaking tubular powders.

In the first case large concrete basins are used. It is advisable to line them with glazed wall tiles. Fine-grained powder is packed in cloth sacks, although this has the disadvantage that it hinders the circulation of water between the powder grains. Strip and tubular powders may be soaked either in baskets made of brass mesh, perforated brass sheets or in wooden boxes with openings through which the water circulates immersed in a vat. To increase the water circulation and thus accelerate the soaking process, pumps may be installed to circulate the water. The pump delivery must be adapted to the capacity of the vats (e.g. in vats with a capacity of about 3.5 m³, water is circulated at about 300 l./hr). To facilitate the loading and unloading of the powder an electric lift with a non-spark mechanism may be installed.

Soaking in hot water is carried out in a very similar manner, although it is more convenient to use vats of a smaller capacity. The device for heating the water should also serve for the circulation of the water in the tub.

A powder soaking vat of the type used in France is shown in Fig. 240. It is made of concrete and divided by a partition into two parts, each 2.3 m long, 1.0 m wide

and 1.4 m deep. The outer walls are 10 cm thick and it takes a charge of 300–700 kg. At some distance from the bottom a tough perforated sheet of brass is laid. Under the sheet there are pipes that supply hot water and drain the water to be heated from the lower section. Each vat has a heating system of its own with a steam injector and is fitted with an overflow for draining the excess water into a special container. It is advisable to use large containers for heating the water to a temperature of 50°C and to draw it from these containers for soaking the powder. The consumption of steam in the vats described above is:

for heating the water from 50 to 80°C—*ca.* 580 kg/hr
for maintaining a temperature of 80°C—650–850 kg/hr

The soaking time depends on the temperature and the type of the powder, i.e. the lower the temperature of the water and the larger the web thickness of powder, the longer the soaking time. In some factories, as a guide it is assumed that decrease of the soaking temperature for coarse-grained powders (a thickness of *ca.* 7 mm) by 10°C requires a threefold longer soaking time, e.g.: at a temperature of 80°C soaking lasts for 32 hr, at a temperature of 70°C it lasts for 96 hr, and at a temperature of 60°C it lasts 288 hr.

Other data show that finer powders (of a thickness of 0.5–2 mm) require an increase in processing time by 50% if the soaking temperature is decreased by 10%.

The soaking time also depends on whether the powder has been previously dried (to 1.5–2% of volatile matter) or only predried (to 10–15% of volatile matter). In the latter case soaking is much more effective although there is a danger that stability may be reduced.

Soaking greatly increases the vivacity of powder to an extent which depends on the method applied. The following example may illustrate the efficacy of soaking preceded or not by drying. One sample of powder was first subjected to drying for 24 hr at a temperature of 55°C, then to soaking for 12 hr at a temperature of 80°C and finally to drying for 24 hr at a temperature of 55°C. Another portion of the same powder was first soaked for 8 hr at a temperature of 50°C, then for 10 hr at a temperature of 80°C and finally dried for 24 hr at a temperature of 55°C.

It was found that the powder soaked without previous drying was faster burning and in the 75 mm gun gave a muzzle velocity higher by 9 m/sec and a pressure higher by 37 kg/cm² than the powder that was dried before soaking.

Table 180 gives data showing the effect of additional soaking (after polishing—see p. 627) on the increase of vivacity of rifle flake powder.

Vigorous soaking may distort the powder strips or tubes, especially thick ones. This is a further reason for recommending that soaking should be conducted at a gradually rising temperature, e.g.: 12 hr at a temperature of 30°C, 24 hr at a temperature of 45°C and 48 hr at a temperature of 60°C. To prevent distortion on soaking, especially at higher temperatures, the strips or tubes can be clipped into bunches with brass collars fitted with brass springs.

After soaking the powder is dried to remove moisture together with some of the residual solvent. Drying at a temperature of 55° requires 4–160 hr depending upon the web thickness of the powder (the duration of drying is given for a drying house with natural air circulation).

TABLE 180

Additional soaking		Increase by a value of	
Time hr	Temperature °C	Δv	Δp
		m/sec	kg/cm ²
24	80	36–44	300–450
24	85	45–60	350–550
24	90	60–70	500–600

After drying, cannon powders, i.e. strips or tubes, are subjected to a second grading as they may have been distorted or discoloured on soaking.

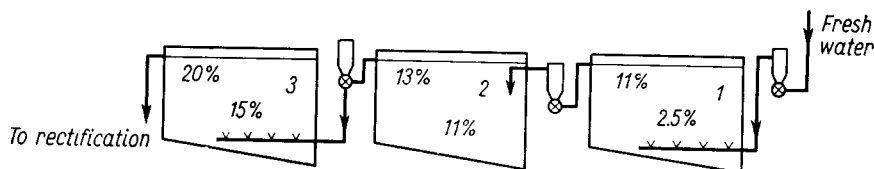

Fig. 241. A battery of powder soaking vats (the content of alcohol in various parts of the vat is indicated).

The recovery of solvent from the water after soaking

The soaking of nitrocellulose powder involves recovery of the solvent (chiefly alcohol) which passes into the water. It is worth while recovering this solvent if the content of alcohol in the soaking water is not less than 5%. By applying the battery counter-current soaking system the alcohol content in the water may be increased to 15–20% and the recovery of solvent thus made more profitable.

Soaking together with solvent recovery was adopted in France during World War I. A battery consisting of three vats was used (Fig. 241). Fresh water heated by steam injection was introduced into vat (1). From there it passed through an overflow and injector to the upper section of vat (2) and then, to the lower section of vat (3). The un-soaked powder was loaded in reverse order: first into vat (3), from there after soaking into vat (2), and, finally, into vat (1). By soaking at a temperature of 50°C, the following concentrations of alcohol were obtained in the vats:

Vat 1 2.5% in lower section
 11% in upper section

Vat 2	11% in lower section 13% in upper section
Vat 3	15% in lower section 20% in upper section

The water from the vat containing an average of 18.5% alcohol was recycled for rectification.

It was thought that this method might lead to much greater losses of diphenylamine than with single stage soaking in water (when the concentration of alcohol is less than 6% by the end of bathing). This however was not so. The losses of diphenylamine on soaking by the battery method are less than 0.01%.

Besides recovering alcohol from the water after soaking it is also necessary to recover the ether and alcohol escaping from the vat as vapour, together with steam, when soaking with hot water. E.g. a powder containing 25% volatile matter (thus only predried and not dried) gives the following composition for the liquid formed by the condensation of vapours evolved from the soaking vat (according to Bonneaud [22], Table 181).

TABLE 181

Components of gaseous phase	Soaking at 50°C		Soaking at 80°C	
	Start	End	Start	End
Ether (%)	92	85	82	52
Alcohol (%)	5	10	13	32
Water (%)	3	5	5	16

In these experiments the quantity of liquids condensed from the vapours evolved during soaking at a temperature of 80°C amounted to 2-3%, calculated on the quantity of powder used.

To recover the solvent vapours evolved during soaking in the hot, the vat is fitted with an air-tight lid and a pipe through which vapours for condensation are conducted. 30 kg of liquid containing 96% of ether were obtained per 700 kg of powder in the vat.

At another plant 4 kg of liquid containing 71% ether and 16% alcohol per 100 kg of the powder soaked at temperatures of 60 and 80°C were obtained by condensation of the solvent vapours.

The content of residual solvent and moisture in the powder

Powder produced with a volatile solvent should be freed from it as thoroughly as possible since too large a content of residual solvent is detrimental to the ballistic stability of the powder. In nitrocellulose powders the content of residual solvent should be lower than 1%; in coarser powders (thicker flakes, strips or tubes) its content may be relatively higher, while it is relatively lower in finer ones. Powders

gelatinized on the surface with camphor also contain a certain amount of camphor unbound with nitrocellulose which may volatilize on heating or storing.

Apart from residual solvent, nitrocellulose powder contains a certain quantity of water, either in the form of residual moisture, incompletely removed by drying, or in the form of moisture introduced to the powder.

Nitrocellulose powder is slightly hygroscopic since it partly consists of non-colloidal fibrous nitrocellulose which is hygroscopic. The colloidal part of the powder is less hygroscopic but retains a certain amount of residual solvent, chiefly alcohol, which as a hydrophilic substance increases the hygroscopicity of the whole mass. The hygroscopicity of nitrocellulose powder mainly depends on the total nitrogen content in the nitrocellulose, the latter being less hygroscopic the higher its nitrogen content (Vol. II, p. 283). Powder made of nitrocellulose with a total nitrogen content of 13% absorbs 1.0–1.5% of moisture. With a nitrogen content of 12.5–13.0% the moisture content of the powder may increase to 1.5–2.0%. These figures are characteristic for the climate of Central Europe. They are lower in a dry climate and higher in a humid one. According to Hansen [23] for a flake or tubular powder of web thickness over 0.8 mm the hygroscopicity may be expressed by the formula:

$$y = \frac{a}{x}$$

where a is a constant, x is the web thickness of the powder flake or tube, and y the moisture content as determined by drying at a temperature of 80°C for 3 hr.

Nitrocellulose powders gelatinized on the surface with centralite, camphor or nitro compounds are less hygroscopic since the layer of gel on the surface constitutes a non-hygroscopic coating which prevents the powder inside from attracting moisture. Nitrocellulose powders containing aromatic nitro compounds, e.g. dinitrotoluene (DNT) or dinitroxylyene (DNX) are less hygroscopic.

Davis [12] reports the following figures characteristic of the hygroscopicity of pyrocollodion cotton containing various substances:

Pyrocollodion cotton with	Hygroscopicity
5% hydrocellulose	2.79%
10% crystalline DNX	2.09%
10% DNX oil	1.99%
10% crystalline DNT	1.92%
20% crystalline DNT	1.23%
25% crystalline DNT	1.06%

Nitroglycerine and nitrodiglycol powders are the least hygroscopic (practically non-hygroscopic) since nitroglycerine–nitrocellulose or nitrodiglycol–nitrocellulose gels are virtually non-hygroscopic. For this reason even those nitroglycerine and nitrodiglycol powders which contain highly nitrated nitrocellulose, partly in a fibrous state, are non-hygroscopic.

Analytical methods for the determination of moisture content and residual solvent content are of the utmost importance in view of the effect exerted by these pro-

erties on the ballistic properties of the powder. Various methods are used in different countries. During World War I the moisture content in nitrocellulose powder was determined as follows:

in Russia	6 hr of drying at 100°C
in France	4 hr of drying at 60°C
in the U.S.A.	6 hr of drying at 60°C, under reduced pressure.

Vieille investigated the loss in the weight of nitrocellulose powder on heating at temperatures from 40 to 130°C. He obtained a typical curve (Fig. 242) which

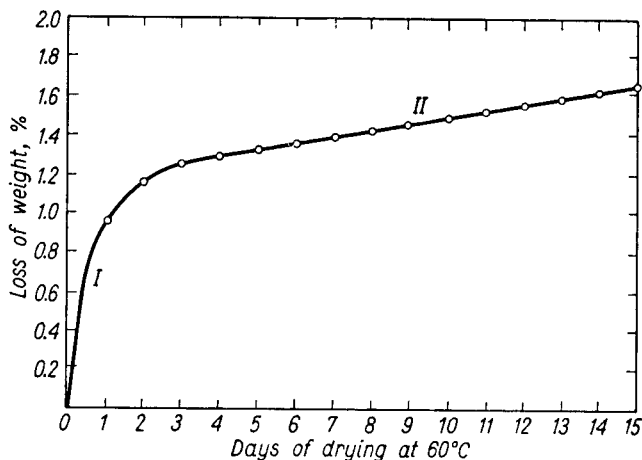

FIG. 242. Loss of weight of nitrocellulose powder at a temperature of 60°C: *I*—evolution of moisture (“elimination”), *II*—evolution of solvent (“coefficient of emission”) [24].

consists of two parts: *I* is very steep and *II* is gently inclined. Part *I* of the curve corresponds mainly to the evolution of moisture and part *II* to that of the residual solvent.

By comparing the losses of residual solvent at temperatures of 110, 75 and 40°C Vieille found that identical losses are obtained on heating the powder for an identical number of

hours	at 110°C
days	at 75°C
months	at 40°C

In France Vieille's experiments provided a basis for the determination of the loss of weight during the first 4 hr of drying at a temperature of 110°C, i.e. the so-called “elimination” (period *I*) and of the loss of weight during the next 16 hr, i.e. the so-called “coefficient of emission” (period *II*).

The coefficient of emission is a function of the content of residual solvent in a powder. It usually amounts to 0.3–1.00%, while the content of residual solvent ranges from 1.5 to 3.5%. The determination of the coefficient of emission is a convenient and rapid method for acquiring an idea of the content of residual solvent.

The total content of residual solvent is determined by partially dissolving a weighed sample of the powder in a solvent (a mixture of alcohol and ether) and adding water so as to precipitate the nitrocellulose from the solution in flocculant form. The weight of this nitrocellulose is determined by evaporation to dryness, repeated dissolution and precipitation with water, and by final drying. The difference between the weight of the powder sample and that of the nitrocellulose is the weight of the residual solvent.

Davis [25] distinguishes:

- (1) Total volatile content (TV)
- (2) External moisture (EM) (determined by drying at 100°C, for 1 hr)
- (3) Residual solvent (RS) (calculated from the difference of $RS = TV - EM$)

Increase in the moisture content leads to a decrease in the vivacity of the powder. According to Vieille the coefficient of the vivacity of powder (p. 530) decreases by 13% when the moisture content increases by 1%.

In small arms and small calibre cannon increase of the moisture content by 0.1% reduces the muzzle velocity by 4–5 m/sec and the pressure by 50–70 kg/cm².

In the climate of Central Europe the moisture content, as determined by drying at a temperature of 60°C for 4 hr, should be constant within the limits of 1–2%. If the moisture content is determined under more drastic conditions the figure is correspondingly higher.

Surface gelatinization

Attempts have been made to improve the ballistic properties of fine-grained (flake or tubular) powders for rifles by coating the grains with a layer which would burn more slowly than the inner part of a grain. Such grains would give a better ballistic effect (would be more “progressive”) since after a certain time of burning the surface of the flakes would decrease and the higher rate of burning would thus facilitate maintaining a steady pressure.

At first, attempts were made to coat the powder grains with gum arabic or gelatine. An aqueous solution of these substances left a layer of phlegmatizing substance on drying. In practice, powders of this kind gave a somewhat better ballistic effect (were more “progressive”) although the most favourable results were obtained by the gelatinization of the surface of the grains with centralite, camphor or DNT. Since nitrocellulose powder contains a considerable quantity of fibrous, non-gelatinized guncotton, coating the grains with a non-volatile solvent gives a totally gelatinized slow burning surface layer. The concentration of the solvent gradually decreases towards the inside of the grains, so that the rate of burning of the powder increases with the combustion of the outer layers.

Surface gelatinization is almost always accompanied by polishing the grains with a small amount of graphite. The duration and temperature of gelatinization depends to a great extent on the type of gelatinizing agent. With a strongly gelatinizing agent the process is shortened and the temperature may be lower. E.g. when using camphor (the strongest employed gelatinizing agent) the temperature may be kept at 30–35°C, while with centralite it should be 50–55°C and with DNT (the weakest gelatinizing agent used) 80–90°C.

The polishing of rifle powder

Flake or tubular rifle powder should be subjected to surface gelatinization and coating with graphite. This is usually called “polishing” and constitutes the most delicate operation in the manufacture of rifle powder (for calibres from 7.6–20 mm).

Polishing is usually carried out in copper or brass drums. These may be cylindrical, with a horizontal axle, and fitted with an opening for loading and unloading and with another for supplying the solutions and predrying the powder (Fig. 243). Drums for

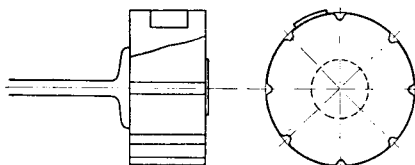

FIG. 243. Schematic view of a design for a drum for polishing fine-grained nitrocellulose powder.

the manufacture of dragées used in the confectionery and pharmaceutical industries (“sweet barrels”) may also be adopted (Fig. 244). Some designs of dragée apparatus provide for heating jackets which surround the polishing vessel, thus making it possible to obtain a higher temperature (50–80°C) inside. The inside of the drums is ribbed which enhances the polishing effect by making the powder rise higher as the drum rotates. The capacity of the drum ranges from 100–300 kg of powder. The rotational speed is approximately 30 r.p.m.

Polishing is usually carried out as follows: the soaked and dried powder is placed into the drum together with the graphite (0.01% by weight of powder). The presence of the graphite from the beginning of the operation increases the conductivity of the powder and prevents it accumulating static electricity, thus reducing the possibility of accidents during polishing.

After a preliminary “dry” polishing for several minutes, an alcoholic solution of a gelatinizing substance—centralite (p. 645) (3% in relation to the weight of powder) or camphor (1.5–2%)—is introduced through an opening in the side wall of the drum. These substances are usually injected in the form of a 10–20% solution sprayed with compressed air. The solution should have a temperature of about 50°C when centralite

is used, or 30–35°C when camphor is used. With centralite the temperature of the powder in the drum should not exceed 40–50°C and with camphor 25–30°C. These temperatures may be attained by maintaining a sufficiently high temperature in the premises where the polishing takes place. The latter temperature should be lower by some degrees than that which is required within the drum since the temperature of the drum contents is somewhat higher than ambient temperature.

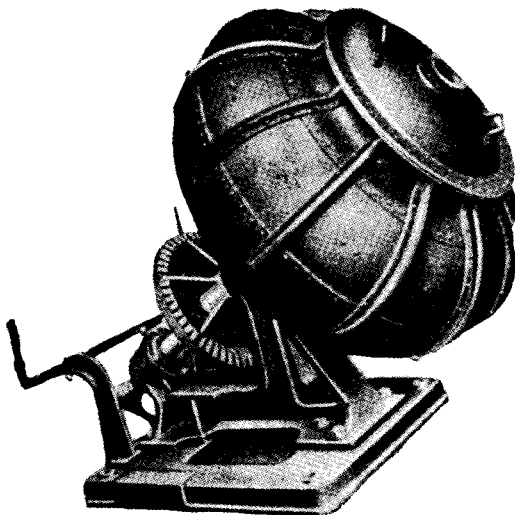

FIG. 244. A dragée apparatus ("sweetic barrel") for polishing fine-grained nitrocellulose powder [7].

The solution is introduced into the drum, which is then closed with a lid and set in motion for one or more hours. A side lid is then opened permitting alcohol to evaporate thereby gradually predrying the powder. During the latter operation a small amount of graphite is added so that its total content amounts to 0.25–0.3%. The evaporation of alcohol from the drum may be combined with the recovery of this solvent. For this purpose the lid is not removed but connected with a duct producing a reduced pressure within the drum. The solvent thus drawn off is then recovered either by condensation or adsorption.

The whole polishing operation lasts for 4–20 hr depending on the method employed. The efficiency of polishing may be checked by measuring the apparent density, which amounts to about 0.700 before polishing and to 0.800–0.900 afterwards. In some factories a charge of wooden balls equal to $\frac{1}{3}$ of the charge of the powder is added when polishing flake powder. The balls hasten the surface smoothing of the powder flakes and their acquisition of the required apparent density. They also prevent caking of the powder grains by the gelatinized solution.

There are various modifications of the polishing process, e.g. the introduction of centralite or camphor without a solvent or in the form of a hot (e.g. 80°C) aqueous

emulsion. This is the last stage of polishing, based on the volatilization of the water. The use of a tilting drum with a heating jacket hastens evaporation of the water or solvent.

After polishing, the powder is soaked for a short period (4–8 hr) at temperatures from 50–80°C, and then dried. This is an operation of great importance designed to remove from the powder any excess of gelatinizing agent unbonded with nitrocellulose. The content of the gelatinizing agent in the powder is thus stabilized. If the powder is not soaked after polishing, but only dried, it may change its ballistic properties on storage. In particular there may be a decrease of muzzle velocity and an increase of pressure, i.e. the powder becomes less progressive, because the excess of the gelatinizer unbonded with nitrocellulose present in the non-soaked powder penetrates into the deeper layers of the powder on storage.

In some countries (U.S.A.) DNT is used for the surface coating of tubular rifle powder, instead of centralite or camphor. The polishing is carried out in the presence of water at a temperature of 80°C, i.e. above the melting point of DNT. As the polishing proceeds, the water is removed by evaporation under reduced pressure, the DNT remaining on the surface of the powder tubes.

Polishing was a hazardous operation until the drums and all the pipelines supplying alcoholic solutions were carefully earthed. Before such precautionary measures were taken there were frequent serious accidents of ignition during polishing.

The polished powder, bathed and dried, should undergo final screening to separate dust and powder grains.

Finishing the powder

In the finishing of powder there are two operations: blending and damping.

Blending. This operation aims at obtaining a large, uniform lot of the product, amounting to 5000–50,000 kg. Powder is produced in small batches (in a kneader 60 kg; from a press still smaller quantities are extruded), so that it is difficult to obtain an identical product each time, due to slight deviations in weighing CP_1 and CP_2 , in adding the solvent, diphenylamine etc. At later stages of processing, uniform batches increase in size and reach a quantity corresponding to the capacity of the soaking vat or the drier. Lots amounting to 1000 kg are obtained in this way. In rifle powders a polishing drum charge, which amounts to about 300 kg of powder, is considered to be acceptably uniform.

For powders which require a high precision in manufacture (polished rifle powders) the ballistic properties are determined for the contents of each polishing drum charge and the contents of all the drums are blended on the principle that powders of various ballistic properties give a mixture with properties corresponding to the arithmetic mean.

The ballistic properties of ordinary cannon powders are more easily controlled, therefore those of individual batches intended for blending are not examined. Exceptions are made when manufacture is restarted after a long interruption or is commen-

ced with a new type of nitrocellulose, or when there are doubts as to the quality of production for some reason or other. In these cases every manufactured batch (e.g. the charge of every drier) is subjected to ballistic tests and then blended according to the rule expounded below.

The blending method depends on whether the powder is a grain (flake or short-tube) or a strip powder (or long-tube).

In the first case (cannon or rifle grain powder) blending is easy and simple funnel equipment, similar to that for blackpowder blending (p. 359) may be used. In the U.S.A. a continuously operating plant, consisting of towers, is used for blending. The towers contain a series of funnels placed one above the other (Fig. 245). The

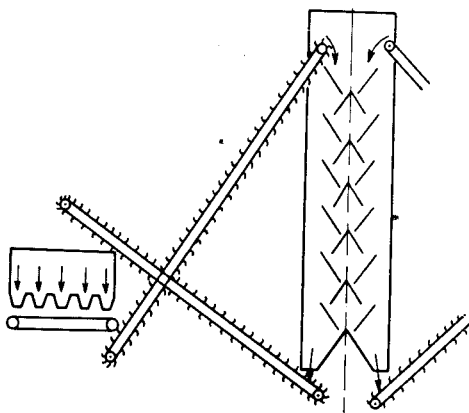

FIG. 245. Schematic view of equipment for blending powder by continuous working.

powder from several drying houses is conveyed to the upper funnel. It flows successively through all the funnels, is partially blended, and falls onto a conveyer which carries it to the upper section of another system of funnels, where the procedure is repeated. Again the powder flows down, is further blended, falls onto the conveyer and is carried to the upper section of the first system of funnels and so on. After several passages the powder is sufficiently blended. A general view of a mixing house is given in Figs. 246 and 247.

Strip powder or long tubular powder can be blended by hand, in the following manner. Sacks with powder from different drying houses are placed around a cloth onto which the workers pour out the strips or tubes and blend them by holding the four corners of the cloth. The powder so blended is poured back into the sacks and the whole process is repeated.

Figure 248 shows an arrangement for blending operations that permits them to be carried out meticulously. Diagram *I* represents the order in which the sacks from 6 units (driers) are placed for blending. Diagram *II* shows the final position of the

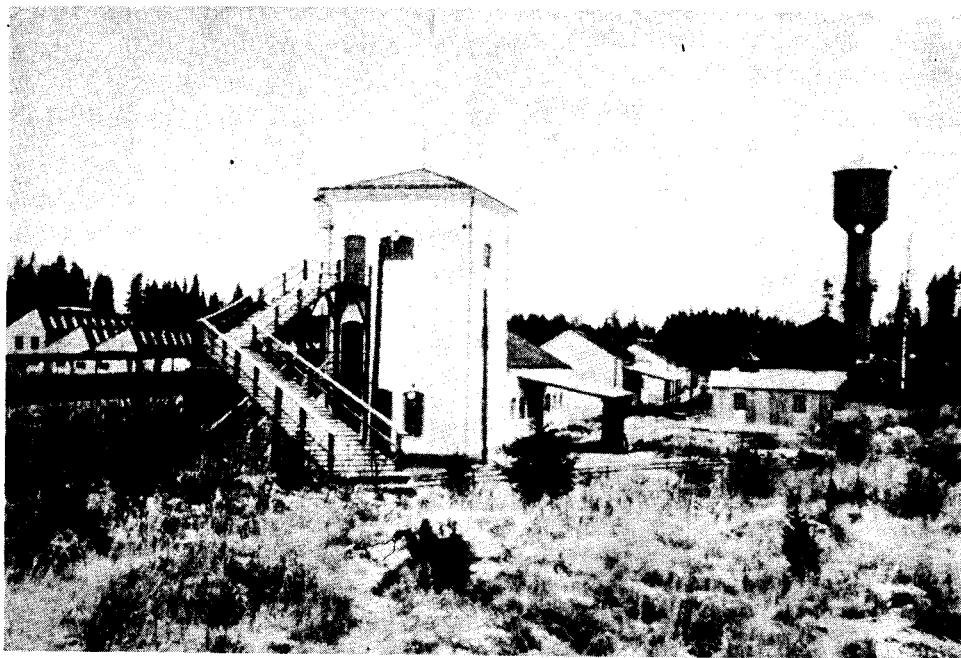

FIG. 246. Mixing house for nitrocellulose powder. Each day's output is hoisted to the upper floor where it passes through a mixing apparatus to form uniform batches of 10-50 tons (Bofors Nobelkrut Factory).

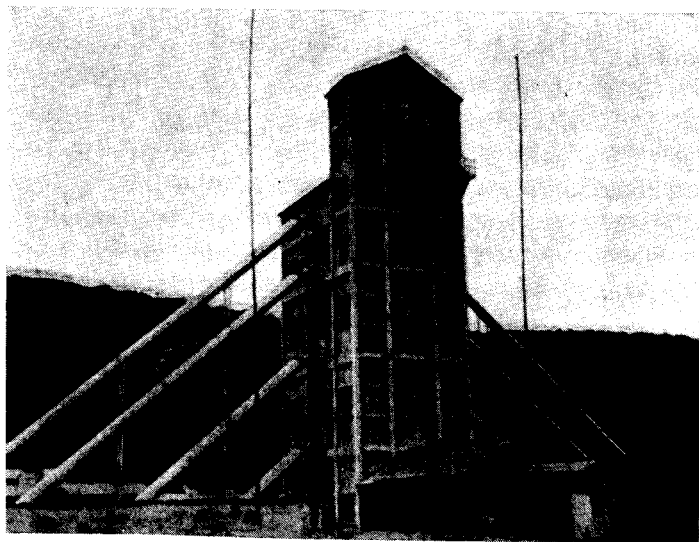

FIG. 247. Smokeless powder blending tower, according to Zaehring [26].

sacks. A worker walks along each side of the rectangle, as indicated by arrows and empties out the sacks of tubes in turn. After blending on the cloth the contents are dumped into the sacks denoted by letter *A* in the figure. The next stage of blending on the cloth gives a new, more or less uniform batch denoted by letter *B*. After the contents of all the sacks placed around the cloth have been blended, the blending operation with sacks *A*, *B* etc. is repeated several times until a sufficiently uniform product is obtained.

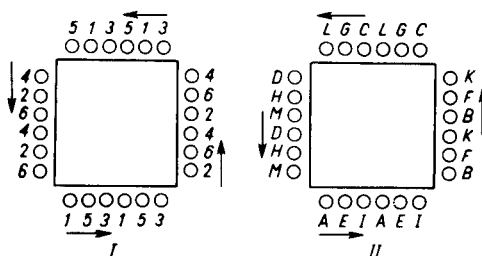

FIG. 248. An arrangement for blending larger grains of powder.

Damping. After soaking and drying the powder usually contains less moisture than that required by standard specifications and should therefore be damped. Methods of damping, like those of blending, depend on whether the powder is in grains, strips or long tubes.

The simplest method of damping granular powder consists of loading it in a rotary drum and injecting the calculated amount of water into it, in accordance with an analytical determination of the powder's moisture content. After rotating the drum with the lid closed for about 30 min the moisture content in the powder becomes uniform.

Strip or tubular powder is usually damped by placing it in a room, either on shelves or on grids standing on the floor, on which vessels of water are placed or water is spilled. A sample of powder is taken every few hours and its moisture content is determined. After one or more days, when the moisture content reaches the standard specification, the powder is taken out of the damping machine and poured into sealed boxes.

The standard specifications permit the moisture content to range within certain limits. This enables the producer to regulate the moisture content to obtain the required ballistic properties. If the powder is too vivacious it should be moistened to the upper limit, while if it is less vivacious, the lower limit is preferable. In determining the moisture content the following practical rule should be observed. In rifle powder an increase of the moisture content by 0.01% lowers the muzzle velocity v_0 by 4–5 m/sec and the pressure by 50–70 kg/cm². In cannon powder the variations of ballistic properties are smaller and depend on the type of powder and on the calibre of the gun.

The processing of waste products

There are two principal types of waste products:

- A. The waste products of non-soaked powder,
- B. The waste products of soaked powder.

The utilization of these waste materials differs in principle. The former are returned to the kneaders to be reworked while, as a rule, the latter are never recycled in the normal manufacture of powder. It is generally recognized that a soaked powder must not be added to the powder dough since it reduces the chemical stability of the powder, except when it is intended for immediate use.

Waste products A derive from various stages in the manufacture of the powder, prior to soaking. They are:

- (1) Scrap comprising remnants of dough from the kneaders and conveyers.
- (2) Shapeless strips or tubes extruded from the press.
- (3) Cakes remaining in the press between the bottom of the press piston and the die.
- (4) Flakes, strips or tubes with non-standard dimensions or shapes, graded after cutting, non-dried or sometimes dried (when graded after drying).

More of materials (2) and (4) is produced from powder of smaller dimensions.

These products are processed by dissolving them in a mixture of alcohol and ether, kneading into a dough, filtering in a hydraulic press to remove mechanical impurities and adding to the fresh powder mass in the kneaders.

Since products (1) and (2) contain a considerable amount of solvent (60–100%), they are loaded directly into the kneader together with the solvent, kneaded for 1–2 hr and filtered in a press in which the die is replaced by a steel plate with circular openings, approximately 1 mm dia. Since there is less ether in the residual solvent in the powder than is primarily used for its manufacture, the solvent added to the waste products should be richer in ether (approximately 70% by weight of ether and 30% by weight of alcohol).

Waste products (4) take longer to dissolve since they contain less residual solvent (20–30%). They are poured into hermetically closed tins (in batches of 30–35 kg) and flooded with solvent, so that its total amount ranges from 100–150%. The solvent should be rich in ether (70–75% by weight of ether and 25–30% by weight of alcohol) as for waste products (1) and (2). After the solvent has been poured in, the tins are sealed, and tumbled through 90° every 15 or 30 min for 2–4 hr. The thicker the powder strips or tubes, the longer they take to dissolve. The tins are then turned upside down and a few hours later returned to the normal position.

With fine-grained powders (web thickness of 0.5–1.5 mm) the contents of the tins may be transferred after a few hours to the kneaders to produce a uniform mass. With coarse-grained powders the dissolution of the waste material requires from four to ten days or more; e.g., with a web thickness of 3 mm the time is 4 days, while with a web thickness of 7 mm it increases to twenty days. After being mixed in the kneaders the dough is filtered and added to the normal dough in the kneaders.

In principle waste products (3) are processed in the same way as waste products (4), although they contain a large amount of solvent. The reason for this is that the cakes are thick and therefore dissolve slowly. To hasten the process the cakes may be cut into several pieces before being placed in the tins.

The quantity of waste products added to the fresh dough in the kneaders varies depending on the amount of factory waste arising during manufacture. From 20 to 90 kg of waste products may be added per 100 kg of fresh nitrocellulose. Naturally the waste products added to fresh powder should have a suitable nitrogen content and total solubility.

Waste materials from soaked powder are used chiefly for preliminary ballistic tests. They can also be converted into less valuable types of powder, earmarked for rapid consumption (practice or sporting powders). Such powders are treated with solvent in the same way as waste products (4), although they require a longer time to dissolve. Thus, during the World Wars, when powders were consumed rapidly, soaked waste products were utilized for this purpose.

THE STABILIZATION OF AN UNSTABLE POWDER

If the stability of the powder does not deviate greatly from the required standard, it may be improved by soaking it in an alcoholic solution of diphenylamine.

For this purpose the powder is put into cylinders, filled with a diphenylamine solution, sealed and left to stand for several days. The concentration of diphenylamine must be such that its total amount is no higher than 0.5–1.0% of the weight of the powder.

Some methods recommend the use of an alcoholic solution with a small addition of ether, e.g. one part of ether per five parts of alcohol. The ether causes part of the nitrocellulose to swell and facilitates the penetration of the diphenylamine solution into the strips or tubes. It should not be used in such an amount as to cause the nitrocellulose to dissolve.

BALL-GRAIN POWDER

Between 1936 and 1940 Olsen *et al.* [27] designed a process for the manufacture of nitrocellulose powder in the form of uniformly shaped balls (Fig. 250). The manufacturing process at Western Cartridge Co., Division of Olin Industries, Inc. at East Alton, Illinois, U.S.A. has been described by Olive [28].

A diagrammatic presentation of the process is shown in Fig. 249. The nitrocellulose containing about 13.45% N is stabilized in kiers, cut in beaters and introduced under water into still (I) fitted with a stirrer, containing ethyl acetate with a small amount of diphenylamine (Fig. 251). Calcium carbonate is also added. The presence of water is not harmful when dissolving nitrocellulose in ethyl acetate. Diphenylamine remains in the organic solvent phase (ethyl acetate), thus neutralizing the acid products dissolved in the ethyl acetate, while the calcium carbonate remains suspended in the

aqueous phase and neutralizes the acid derived from nitrocellulose and passing from the organic to the aqueous phase. The neutralization of the acid products in the nitrocellulose and the final stabilization of the nitrocellulose are thus completed, Olsen claims that for this reason there is no need to use a completely stabilized nitrocellulose since the same process may be performed more quickly and equally successfully with a nitrocellulose which has not been stabilized in boilers and poachers.

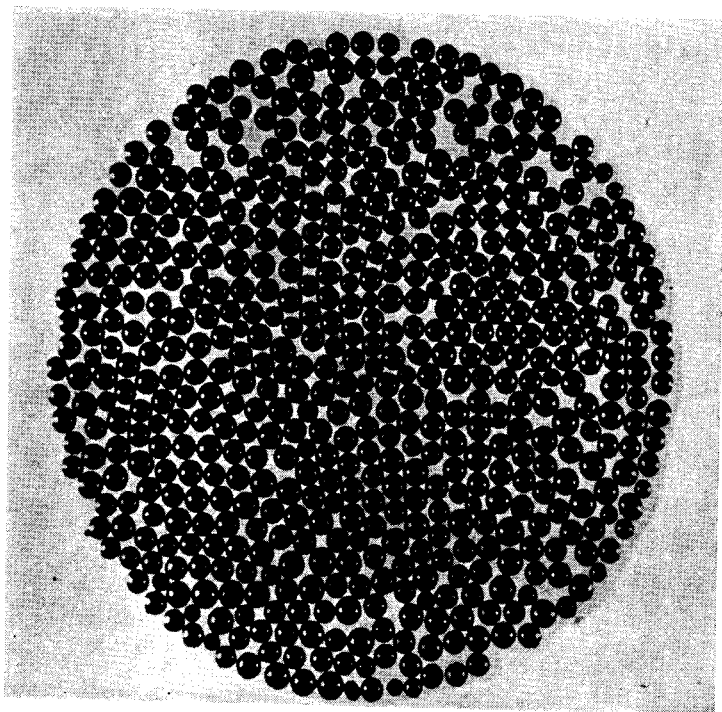

FIG. 250. Ball-grain powder, according to Olin Industries, Inc. [29].

After the contents have been mixed for 0.5 hr a solution of a protective colloid (gum arabic or starch) is added to secure uniformity of the suspension. The material is then stirred vigorously until small balls are formed. From that moment the procedure varies depending on whether porous, fast burning or dense, slow burning balls are required. In the first case ethyl acetate is distilled off rapidly by reducing the pressure in the still. During distillation the balls harden, but should retain their shape. If the solvent is distilled too quickly, the grains become elongated. The distillation rate should be such that the solvent is evaporated from the surface of the grains no faster than it moves from the interior to the surface. The distillation should therefore be slow at first and more rapid towards the end when the hard surface of the balls is already shaped. Since they contain much water, drying, which is the next operation after grading, makes them porous.

If, however, the balls are dehydrated before hardening, i.e. before distillation of the solvent, they have a high density. To dehydrate them some sodium sulphate is

introduced into the apparatus. Due to the high osmotic pressure of the aqueous solution surrounding the balls water moves from them to the solution, so that they are dehydrated. The degree of dehydration is controlled by altering the time, the temperature and the concentration of the sodium sulphate.

The distillation of ethyl acetate is carried out either by reducing the pressure in the apparatus or by raising the temperature to 77°C (the boiling point of ethyl acetate under atmospheric pressure).

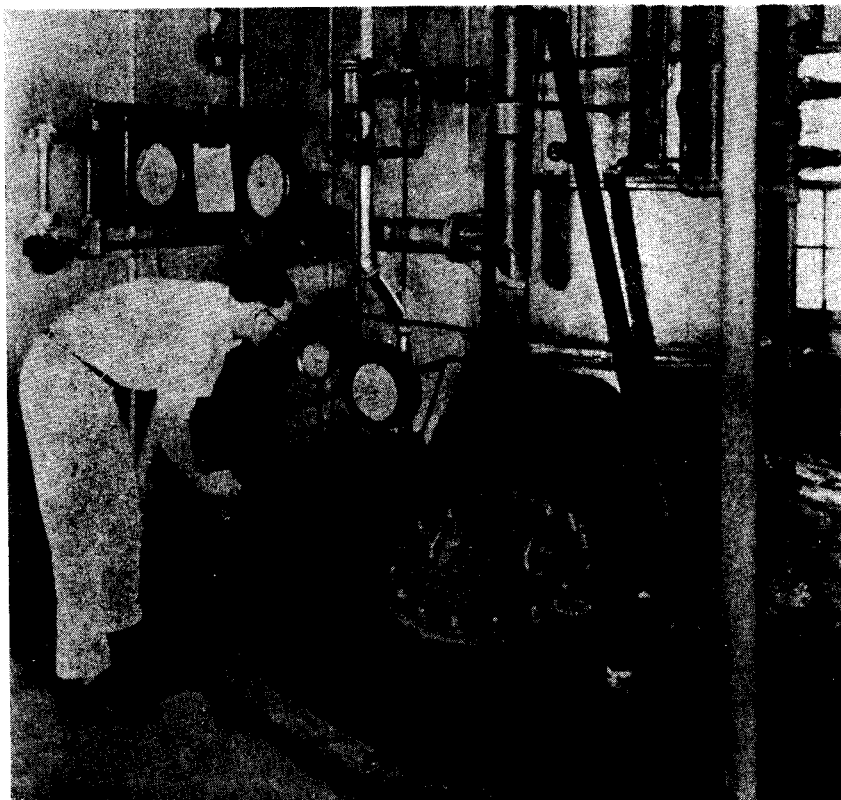

FIG. 251. General view of the large still (Courtesy Olin Industries, Inc.) [29].

The distillate (in receptacle (2)) consists of a layer of ethyl acetate plus water and a layer of water in which 8% ethyl acetate is dissolved. The aqueous layer is rectified to recover the solvent. In all, 95% of the ethyl acetate used is recovered from the distillate and recycled for manufacture.

After the balls have cooled in the slurry they may be coated with nitroglycerine. For this purpose they are treated with an aqueous emulsion of nitroglycerine dissolved in toluene, using nitroglycerine up to 15% of the weight of the powder. By heating at a reduced pressure the toluene is distilled off, leaving a solid solution of nitrocellulose in the nitroglycerine deposited as a layer on the surface of the balls. This surface may then be coated with centralite, applied in a similar manner, i.e. in the form of

an emulsion dissolved in a solvent immiscible with water, in which the nitrocellulose is insoluble, i.e. in toluene.

If the ball-grain powder is to be a true double base powder with a relatively high content of nitroglycerine, the nitroglycerine is usually introduced at the first stage of manufacture, together with the ethyl acetate solvent. This forms a solution of nitrocellulose and diphenylamine in nitroglycerine and ethyl acetate. Subsequent procedure is similar to that described above, i.e. ethyl acetate is rapidly mixed in, the balls are dehydrated and solvent distilled off. The whole operation, from dissolving to the end of graining, takes approximately 16 hr for a batch of 3000 kg.

The aqueous slurry of grains produced in this way is conveyed to storage tank (3) and held there pending a laboratory report on the suitability of the product. If this shows that balls have incorrect dimensions, they are separated from the water and returned to be re-dissolved in ethyl acetate and recycled.

If the laboratory report is satisfactory, the balls in the slurry are graded by pumping the slurry over a succession of water-sprayed, rotating, drum-type screens. Fig. 252 gives an idea of their design. The graded balls are directed to storage tanks

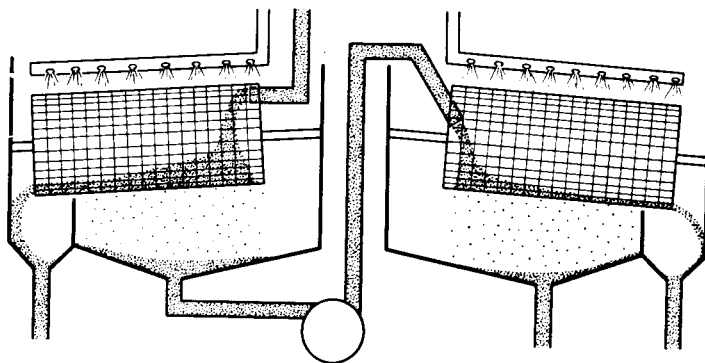

FIG. 252. Diagrammatic presentation of rotating drum screens, according to P. Brown [30].

(5), from which the slurry is pumped over into a still (6) in which the balls are coated with a gelatinizing agent—usually dibutyl or diphenyl phthalate, with or without the addition of carbamite (centralite). Formerly centralite alone was used for coating.

The gelatinizer is introduced into the still as an emulsion. The proportion of water to powder in the still is 3 l. of water per 1 kg of powder. Steam is introduced into the heating jacket and the charge is slowly agitated until the gelatinizer has penetrated to the desired depth. To coat a batch of 5000 kg takes 4–5 hr, after which the coated grains are separated from the water on a vacuum filter (7). A cross-section of a coated grain is given in Fig. 253. After filtering about 8% of water remains in the powder. The damp powder is dried on a conveyer in a tunnel drier equipped with infra-red lamps (8). The conveyer is a travelling belt of rubber and canvas 48 in. wide

and 80 ft long (Figs. 254 and 255). The tunnel walls consist of light metal panels, insulated and hinged to serve as explosion hatches. One hundred and forty infra-red lamps, each of 250 W, are arranged in twenty-eight rows of five lamps each, more closely

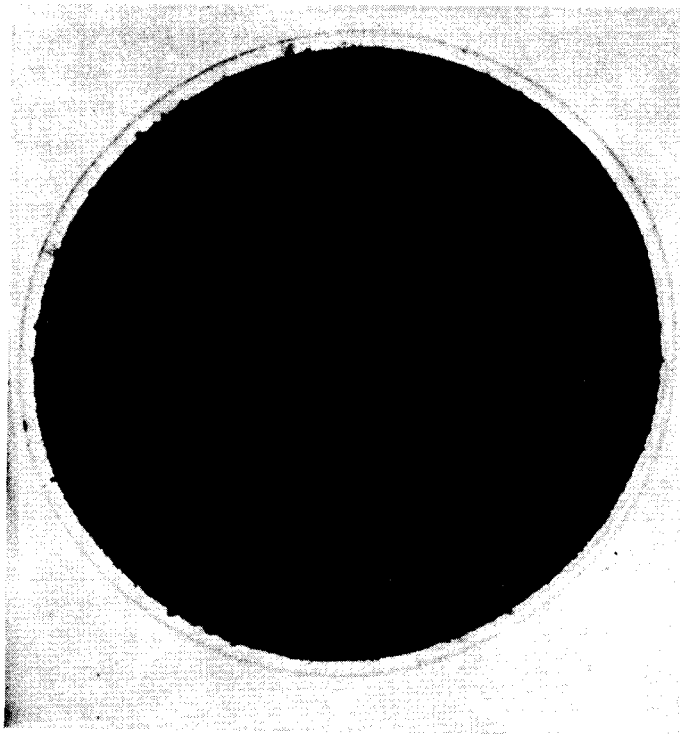

FIG. 253. Cross-section of a ball powder grain magnified 300 times. The light ring on the outside indicates the location of the gelatinizer (phlegmatizer). (Courtesy Olin Industries, Inc. [29].)

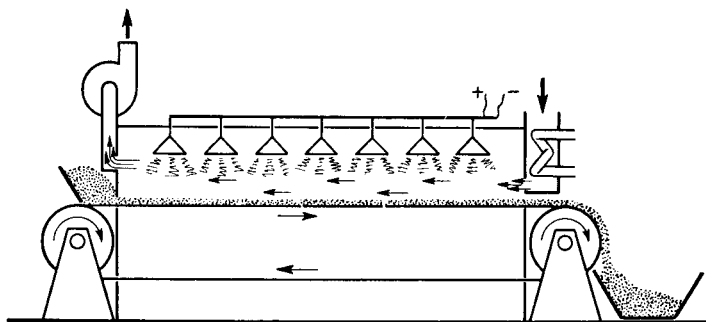

FIG. 254. Diagrammatic presentation of infra-red drier, according to P. Brown [30].

spaced at the wet than at the dry end. They are placed about 18 in. above the bed of powder. A relatively weak current of air flows counter to the direction of movement of the powder.

The damp powder is fed directly to the belt from a hopper containing an agitator, and drying is accomplished at a rate of 140 lb (53 kg) per drier per hour, at a temperature of 72°C. The air supplied is heated to about 50°C by steam coils, and the temperature in the tunnel rises due to the heat from the lamps.

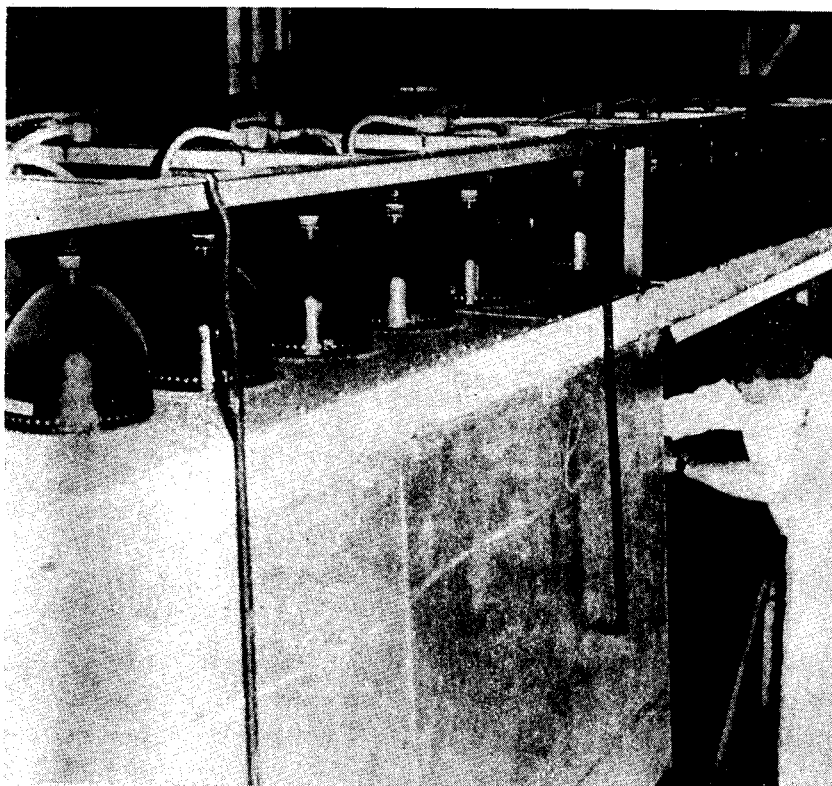

FIG. 255. General view of infra-red drier (Courtesy Olin Industries, Inc. [28]).

The temperature of the powder is controlled by thermocouples on the surface of the moving bed from which three banks of lamps are automatically controlled. In addition six other thermocouples per drier actuate recorders but do not control.

Power consumption of the driers averages 0.196 kWh per pound of dry powder and drying time is approximately 60 min. The operation is safe. The only fire which occurred between 1942 and 1946 was one that was started deliberately to see what the result would be. It was brought under control so quickly that production was resumed in less than two hours, with no damage to the lamps, belt or housing (Olive [28]).

Since the shape of the balls is ballistically unfavourable, they may be flattened between rolls before the final drying so that they acquire a more favourable form.

The balls are conveyed to the rolls in a slurry from apparatus (6) and pass through a feed tank, and then between the rolls (9). A general view of the rolls is given in

Fig. 256. Larger balls may be flattened to reduce their dimensions and burning time. E.g. U.S. 0.45 ammunition requires balls of 0.006–0.010 in. dia. They may be produced by rolling balls to a web (minimum) thickness of 0.004 in. Rolled powder grains are shown in Fig. 257.

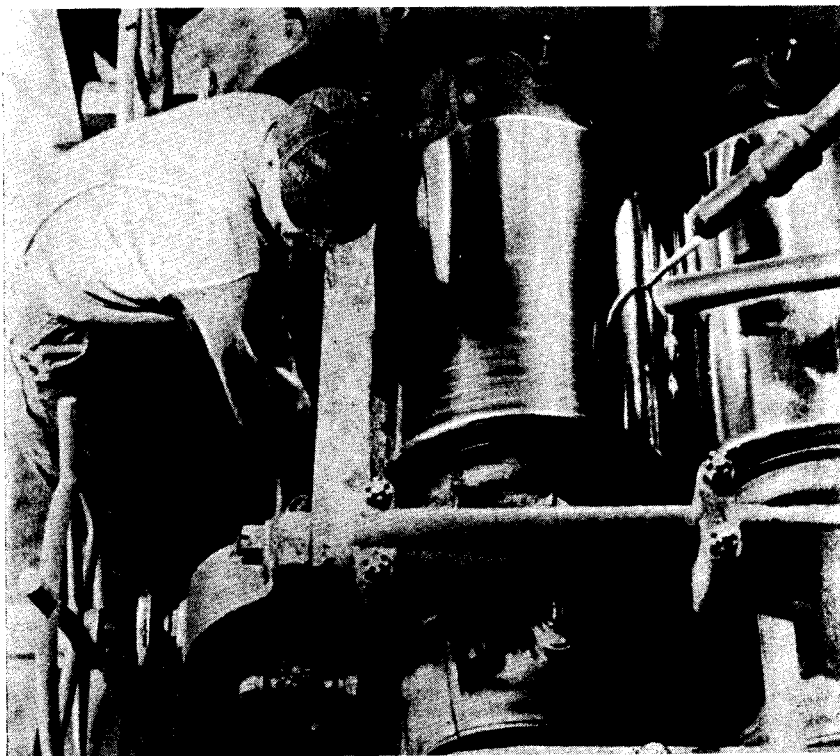

FIG. 256. General view of rolling operations (Courtesy Olin Industries, Inc. [29]).

After flattening, the slurry passes to the centrifuge (10) (Fig. 249) for dehydration and then to the drier (8), as described above.

The ball-grain powder is then processed in the conventional manner, i.e. being weighed (11), polished and coated with graphite (12), blended in towers (13), similar to those described above (pp. 628–629), and stored (14).

The gravimetric density of ball-grain powder varies from 0.400 to 0.975.

Olsen suggested using old nitrocellulose powder, withdrawn from use due to insufficient chemical stability, for the manufacture of ball-grain powder, instead of nitrocellulose. The powder is milled in disintegrators under water containing a suspension of calcium carbonate to neutralize the acid decomposition products. Coarse grains are thus formed which after the excess water has been removed in a centrifuge are introduced into ethyl acetate containing diphenylamine. The substance is then stabilized and traces of acid are removed. Further processing is as described above.

The advantage of this method of powder manufacture is that it is quicker and

much safer than the usual methods, since kneading, pressing and cutting are eliminated and all operations are carried out under water.

Olin Industries [29] report that the safety is further enhanced by the fact that at any moment a relatively small amount of material is being processed.

A third important safety feature is the continuous drying by infra-red radiation. No "drying" to remove solvent is required and so no dangerous mixtures of organic

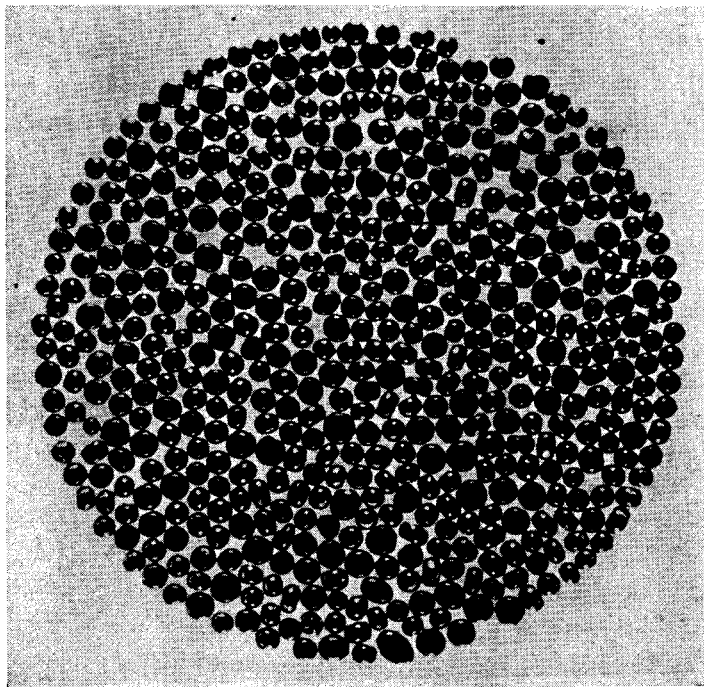

FIG. 257. Powder rolled from 0.020–0.025" dia. to a thickness of 0.018" (Courtesy Olin Industries, Inc. [29]).

vapours in air are formed as in the conventional process. Approximately 100 lb of powder is dried at a time. This amount is within the safety limits for this type of equipment.

Olin Industries report that no fatal accident attributable to ball powder has occurred in twelve years of manufacture, during which time more than 60,000,000 lb of ball powder have been produced. Labour requirements are low: ball powder can be manufactured by using fifty man hours per 1000 lb of finished powder as compared with 125–200 man hours per 1000 lb required by the conventional process for making extruded powder.

NITROCELLULOSE BULK POWDER (SCHULTZE POWDER)

These propellants containing mainly fibrous non-colloidal nitrocellulose are usually referred to as Schultze powder, after the inventor—see p. 528.

In Great Britain they are frequently referred to as E.C. powder (this stands for Explosives Company, one of the early manufacturers in England). In the U.S.A. they are usually referred to as bulk powder, probably because they were loaded in bulk, volume for volume, with blackpowder.

The production of nitrocellulose bulk powder is based on the same principle as that of blackpowder. Nitrocellulose together with water, potassium or barium nitrate and a binding substance (e.g. gum arabic, gelatine, agar-agar, starch) is mixed in edge runners, granulated, screened and dried. On drying the grains harden like those of blackpowder. The mixture may also include vaseline, which facilitates the adhesion of the grains, or camphor, acting as a binder by gelatinizing the nitrocellulose. Powders of this kind are extremely fast burning and are used in sporting or practice ammunition. The composition of some of them is tabulated below (Table 182).

TABLE 182
COMPOSITION OF SOME SCHULTZE SPORTING POWDERS

Ingredients	EC	Amberite	Schultze	Kynoch	Chasse M
CP ₁ (guncotton)	40	13	63	—	56
CP ₂ (collodion cotton)	40	59	—	53	15
KNO ₃	4.5	1.5	2	1.5	5
Ba(NO ₃) ₂	7.5	19	26	22.5	20
Vaseline	—	6	5	—	—
Starch	—	—	4	—	—
Woodmeal	4	1.5	—	3	—
Agar-agar	—	—	—	—	1
DNT	—	—	—	20	—
Camphor	4	—	—	—	3
Heat of explosion (kcal/kg)	762	745	786	807	—

According to the method adopted in France the manufacturing process consists of the following operations:

(1) Mixing the ingredients in an edge runner with the addition of about 10% water which takes approximately 1 hr. Sometimes, in addition to water a certain amount of alcohol-ether mixture is added (e.g. 50–60% of the weight of nitrocellulose). Mixing should then be commenced in a hermetically sealed kneader to avoid losing ether and alcohol. After mixing and the partial dissolution of nitrocellulose the mass is reloaded into edge runners, and after kneading again is further processed.

(2) Rubbing the mass through a 1.5–2 mm mesh sieve to form grains.

(3) Granulating, which is carried out by placing the grains in a rotating wooden drum, in which they are rounded off, forming granules of different sizes.

(4) **Drying.** The granules obtained in the wooden drums are dried at a temperature of 45°C. Volatilization of the water makes the grains harden.

(5) **Grading.** The dried grains are graded by passing them through 0.5–1.5 mm mesh sieves.

(6) **Polishing.** The graded grains are placed in small rotating drums made of brass. An alcoholic solution of camphor, or acetone with alcohol, or an alcohol-ether mixture is injected into the powder charge in the drums. The introduction of solvent causes the formation of a coating on the grains which makes them harder and makes the powder burn more progressively, i.e. the outer layer burns more slowly than the interior of the grain. The gravimetric density of the grains increases slightly on polishing. E.g., with Poudre Chasse M it increases from 0.380 to 0.400–0.430.

(7) **Drying and final grading** are the same as (4) and (5).

There are designs which make it possible to carry out operations (3), (4) and (5) in one apparatus comprising a drum that acts as a granulator, a drier and a grading machine. This is a long, inclined rotating drum with a system of screens inside. Warm, drying air is passed through the drum. As the drum rotates the grains are polished, dried in the air stream and graded between the screens.

According to U.S. Army Specification No. 50-13-8B E.C. powder should pass two tests [31].

When the powder is to be used in blank ammunition the wad from the round loaded with a specified weight of powder when fired in a 0.30 calibre rifle shall not penetrate a craft screen placed at a specified distance in front of the muzzle of the rifle. Only 1% of variation is permitted.

The same powder can be used as a high explosive to fill hand grenades. On detonation it should give 40 ± 10 fragments large enough to be held on a 2-mm mesh screen.

DOUBLE BASE POWDERS

As with nitrocellulose powders the manufacturing processes of nitroglycerine powders described below should be regarded as examples of typical methods which may vary from one country to another. As before, the author has endeavoured, as far as possible, to draw attention to the differences in methods adopted in various countries.

Smokeless powders containing nitroglycerine are classified into two types: those produced with the use of a volatile solvent and those produced without such a solvent. In both types nitrocellulose is in a completely colloidal form.

Powders with a volatile solvent are becoming obsolete and are now produced in only a few countries (Great Britain) whereas those without a volatile solvent are being used increasingly. Nitroglycerine powders are designated as follows: France—SD; Germany—RPC; Great Britain—Cordite SC (solventless cordite); Poland—BR; the U.S.S.R.—letter H (Russian “N”) following the figures showing the dimen-

sions of tubes. In the U.S.A. nitroglycerine powders are called "double base powders" i.e. those composed of two explosive ingredients: nitroglycerine and nitrocellulose.

Double base powders, i.e. nitroglycerine powders without a volatile solvent also include modern flashless powders containing nitroguanidine.

NITROGLYCERINE POWDERS WITH A VOLATILE SOLVENT

Cordite Mk I and Cordite MD

British cordite is a typical powder of this kind. There are two types: the obsolete Mark I and the more modern modified cordite MD. They differ in composition (Table 183).

TABLE 183
COMPOSITION OF CORDITES (%)

Ingredient	Mark I (abbr. Mk I)	MD
Nitrocellulose (12.9-13.1% N)	37	65
Nitroglycerine	58	30
Vaseline	5	5

Cordite MD is an improved powder. It contains less nitroglycerine than Mk I and is, therefore, less erosive. Cordite owes its name to the fact that it is made of cords, the size (diameter) of which is denoted by a figure giving the diameter of the die in hundredths of an inch. Thus, for instance, Cordite 50 denotes a powder in the form of a cord extruded from a die of $\frac{1}{2}$ in. (50/100 in.) dia.

Cordite MD is manufactured by a method very similar to that used for the manufacture of nitrocellulose powder.

Drying the nitrocellulose. Dehydration with alcohol is not possible in this case since in powders of this kind there is no alcohol in the solvent. To improve operational safety in the drying house, and especially to prevent the formation of dust, the damp nitrocellulose is pressed into cylindrical blocks. Natural draught drying houses are used. Drying takes several days at a temperature of 43°C. The operation is dangerous because of the sensitiveness to friction of dry nitrocellulose and its inflammability. Precautionary measures should therefore be taken, especially when unloading the nitrocellulose from the drying house. It should be unloaded only after cooling, with great care to avoid friction. The regular removal of nitrocellulose dust by sweeping the floor and dusting the radiators, shelves etc. is also of great importance.

Premixing nitrocellulose with nitroglycerine and incorporation. For this purpose a special lead table in the form of a trough is used. One of its ends is slightly raised and perforated with holes 1-1.5 mm dia. which form a kind of screen. Blocks of nitrocellulose are placed in the trough and a weighed amount of nitroglycerine is poured into it. A worker wearing rubber gloves first mixes the ingredients, and then

rubbs the mixture carefully through the lead screen, from which it falls into a bag attached below.

The cordite paste so obtained is next loaded into Werner-Pfleiderer kneaders where it is incorporated with vaseline and acetone. The quantity of acetone in relation to the nitrocellulose is 50–60%. Kneading lasts for 2.5–3.5 hr.

Next the dough is formed into cords by pressing it in hydraulic presses with suitably shaped dies.

The pressing of nitroglycerine powder is quite a hazardous operation. The cordite extruded from the press often ignites although this is not dangerous since the presses are small with a cylinder of low capacity. The presses should be arranged so that the workers operating them have a speedy exit from the building if a fire breaks out.

Drying. The solvent is removed from the cordite by drying at temperatures of 38–43°C for several days to a volatile matter content of 0.4–0.6%. The drying time depends on the thickness of the powder cords. Cordite MD loses its solvent more easily than cordite Mk I and therefore dries more quickly.

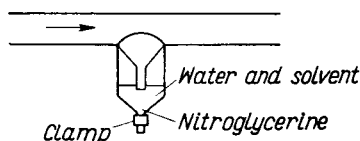

FIG. 258. A device for trapping nitroglycerine in pipelines.

The drying houses employed for cordite consist of rooms with shelves heated from beneath by radiators. Natural draught or forced circulation may be used. Air containing acetone from the drying houses is passed into recovery towers where it is sprayed with water. A dilute aqueous solution of acetone is thus recovered and then rectified. There is better recovery of acetone if the towers are sprayed with sodium hydrogen sulphite which reacts with the acetone (R. Robertson and Rintoul method [32]). The solution is then concentrated and after acidification the acetone is distilled off. The air exhaust ducting (especially with forced air circulation) should be fitted with equipment for trapping the entrained nitroglycerine (Fig. 258) so as to prevent the penetration of nitroglycerine to the machinery (e.g. to the fan).

Blending and packaging. Individual lots of cordite are blended to obtain a uniform product by the usual methods. It is then packed into wooden semi-hermetic boxes since it is non-hygroscopic (p. 532).

Cordite RDB

Since there was a great shortage of acetone for the manufacture of cordite in Great Britain during World War I, a solvent composed of alcohol and ether in a weight ratio of 2 : 3 was used. Since the nitrocellulose usually employed for the manu-

facture of cordite is insoluble in this mixture, nitrocellulose containing 12.9–13.2% N was replaced by a much lower nitrated one which contained 12.2% N and was soluble in the alcohol–ether mixture. The composition of cordite RDB was:

Nitrocellulose (12.2% N)	52%
Nitroglycerine	42%
Vaseline	6%

About 90% solvent was used, consisting of 58% ether and 42% alcohol.

In principle the manufacture of cordite RDB was similar to that of ordinary cordite with the difference that instead of drying the damp nitrocellulose it was dehydrated with alcohol and the required amount of ether and additional alcohol were introduced in the kneader. The manufacture of cordite RDB was discontinued after the war since its ballistic properties were inferior to those of common cordite.

Powders of the cordite type were never widely used outside Great Britain. For a certain time before World War I cordite was in use in the U.S.A. Navy. Before and during World War I a tubular nitroglycerine powder, similar to cordite in its composition, was manufactured in Austria–Hungary. It contained 30–40% nitroglycerine and 60–70% nitrocellulose (13.2–13.4% N). Acetone was used as a solvent. In Germany a similar powder containing 25–30% nitroglycerine was manufactured up to 1912.

SOLVENTLESS NITROGLYCERINE POWDERS

In completely colloidal nitroglycerine and nitrodiglycol powders these nitric esters are non-volatile, explosively active solvents. Similarly, triethylene glycol dinitrate (nitrotriethylene glycol) is used as an ingredient in some powders without a volatile solvent.

Aromatic nitro compounds may also be used as active solvents. During World War I they were adopted to compensate for the shortage of nitroglycerine. They have also been used more recently to reduce the heat of explosion and flash. In World War II they were used partly for this purpose and partly to make up for the lack of such non-volatile, explosively inert solvents as carbamite (centralite), acardite and urethanes. When they are included in nitroglycerine and nitrodiglycol powders, it is possible to reduce the content of these nitric esters by increasing the content of nitrocellulose. This gives a powder of a lower calorific value and erosiveness. Non-volatile solvents are also used in the surface gelatinization of semi-colloidal nitrocellulose rifle powder (see above, p. 625). They produce an outer layer that is completely colloidal, which burns more slowly and thus improves the progressiveness of the powder.

Camphor was also used for the same purpose. It has the advantage over centralite of being a better solvent for nitrocellulose so that it can be used in smaller quantities and can be gelatinized at lower temperatures.

Centralite (called in Great Britain carbamite) is *sym*-diethyldiphenylurea. It was obtained by Zentralstelle für wissenschaftlich-technische Untersuchungen in Neu-

babelsberg and first used in powder manufacture in 1906. Shortly afterwards a homologue of this substance—*sym*-dimethyldiphenylurea—was prepared and put to use. The diethyl derivative was named Centralite I and the dimethyl derivative Centralite II. Other urea derivatives have also been developed and used, e.g. Acardite—*unsym*-diphenylurea.

During World War II N-arylurethanes were extensively used for the manufacture of nitroglycerine powder, e.g. ethylphenylurethane, diphenylurethane, *o*-tolylurethane, also, to a lesser extent, N-arylsubstituted amides of aliphatic acids, e.g. formyldiphenylamine were used. The latter was used in Japan [33] as gelatinizer and stabilizer.

The formulae of the most important non-volatile solvents are given below. All of them are characterized by the presence of carbonyl groups and with the exception of camphor by the presence of the amido group $-\text{CO}-\text{N}\langle$.

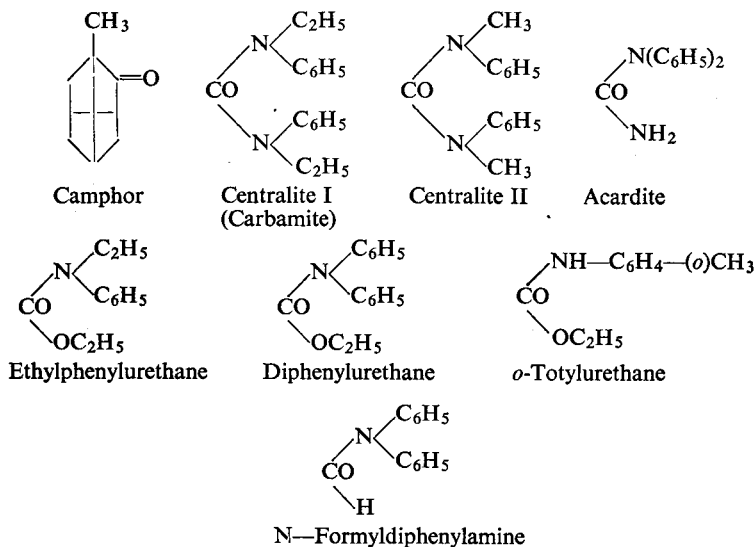

Non-volatile phthalic esters, (e.g. butyl phthalate) are also used for the manufacture of some nitrocellulose and nitroglycerine powders.

Individual non-volatile solvents vary in their capacity for dissolving nitrocellulose. The type of nitrocellulose dissolved is also a factor to be considered. Marquayrol and Florentin [34] report the following figures which denote the amount of solvent required to obtain a uniform gelatinous film (Table 184).

TABLE 184

Solvent	CP ₁	CP ₂
Dimethylphenyl- <i>o</i> -tolylurea	260	65
Dimethyldiphenylurea	—	80
Diethyl sebacate	320	65
Diethyl phthalate	360	95

Davis [25] found that non-volatile solvents vary in their capacity for gelatinizing nitrocellulose, depending on the liquid in which they are dissolved. The following data show the gelatinizing power of pyrocollodion cotton (Table 185). The figures indicate the parts of non-volatile solvent required for the complete gelatinization of 100 parts of pyrocollodion cotton.

TABLE 185

ABILITY TO COMPLETELY GELATINIZE PYROCOLLODION COTTON
OF VARIOUS NON-VOLATILE SOLVENTS, ACCORDING TO DAVIS [25]

Solvent	In alcohol	In benzene
Methylurea	100	100
Ethylurea	100	100
<i>Sym</i> -dimethylurea	60	70
<i>Sym</i> -diethylurea	50	50
<i>Asym</i> -dimethylurea	100	100
Tetramethylurea	80	—
<i>Sym</i> -diphenylurea	100	100
<i>Asym</i> -diphenylurea	100	100
Triphenylurea	—	35
Tetraphenylurea	160	30
Centralite II	70	25
Centralite I	70	30
<i>Asym</i> -dimethyldiphenylurea	60	—
Carbamic acid ethyl ester	140	80
Methylcarbamic acid ethyl ester	90	60
Ethylcarbamic acid ethyl ester	90	60
Phenylcarbamic acid ethyl ester	20	90
Phenylcarbamic acid phenyl ester	200	200
Diphenylcarbamic acid phenyl ester	80	70
Methyl phthalate	95	70
Ethyl phthalate	95	50
Isoamyl phthalate	95	50
DNX oil	120	130
TNT	—	300

Symmetrically substituted, especially tetra-substituted, urea derivatives have particularly good gelatinizing properties.

The manufacture of solventless nitroglycerine (also nitrodiglycol) powders (i.e. powders without a volatile solvent) differs from that of powders with a volatile solvent at the stage when the nitrocellulose is converted into a colloidal state. This highly important stage is not accomplished in a kneader, but between rolls heated to a high temperature (80–90°C). An elevated temperature is needed during pressing to obtain the required plasticity.

Nitroglycerine powders are produced in the form of flake powder, which is easy to manufacture (ballistite). They are also produced as tubular powders.

Huffington's [35] investigations showed that nitroglycerine powder manufactured without a solvent is not completely uniform, the nitroglycerine being present in the form of small drops. This means that nitroglycerine powder burns rather irregularly at relatively low pressures (e.g. 27 atm) common in rockets. The irregularity manifests itself as successive periods of slow- and fast-burning due to the explosions of the nitroglycerine drops.

Huffington carried out his experiment with a powder containing 29% of nitroglycerine and 10% of dinitrotoluene, as mentioned before (pp. 644, 650 and 653).

Ballistites

Ballistites initially consisted of equal amounts by weight of nitroglycerine and soluble nitrocellulose CP₂ with the addition of aniline or diphenylamine as stabilizers. It was found, however, that the presence of aniline and diphenylamine is detrimental to the stability of the powder, and they were therefore omitted. The valuable properties of centralite as a solvent of low basicity were then recognized and it was used both for its ability to dissolve the nitrocellulose and for its stabilizing action.

This led to the development of ballistite 50/50 which is still in use. It consists of:

Collodion cotton	49-49.5%
Nitroglycerine	49-49.5%
Centralite	1-2%

Ballistite 40/60 has a reduced content of nitroglycerine. It consists of 60% collodion cotton and 40% nitroglycerine. To this mass 1-2% centralite is added.

The manufacture of ballistite is divided into the following stages.

The incorporation of nitroglycerine and nitrocellulose. The two ingredients and carbamate are simply mixed in hot water by stirring with compressed air. Water is heated to a temperature of 60°C. Nitrocellulose is suspended and nitroglycerine poured into the slurry of nitrocellulose. The required amount of centralite may be dissolved in nitroglycerine. On mixing, the nitrocellulose absorbs the nitroglycerine. After 15-30 min, when the nitrocellulose is uniformly mixed with the nitroglycerine, the contents of the vat are poured into a cloth filter. The vat was usually emptied either by tilting (convertor principle) or by lowering a flap clamped with a lever to an outlet in the bottom.

The water may be removed from the nitrocellulose-nitroglycerine "paste" by centrifuging. The system described is primitive and virtually obsolete, but it is quite adequate for the manufacture of ballistite and is therefore still in use. A more modern system, giving a uniform paste with more evenly incorporated nitroglycerine is based upon the use of an aqueous emulsion of nitroglycerine (see Fig. 268).

Rolling (for drying). The damp mass is passed between rolls heated to a temperature of 50-60°C. Most of the water is removed and at the same time dissolution

of the nitrocellulose in the nitroglycerine is promoted. This causes the mass to form into lumps which are here and there transparent. For this operation horizontal rolls are commonly used. (Fig. 259). Under the roll there is a tin tray to catch the water pressed out of the mass, and the pieces of paste that drop during rolling.

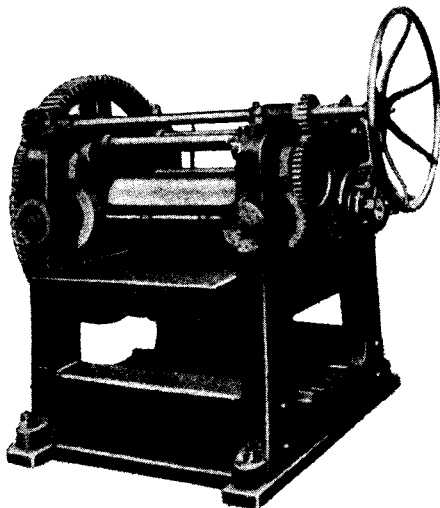

FIG. 259. Horizontal drying rolls [7].

Drying is complete when no more water is squeezed out of the paste. The amount of moisture is reduced to *ca.* 5%.

Very often the "differential rolling mills" are used here: two horizontal cylindrical rolls rotate at different circumferential speeds (the ratio of the speeds being 1.5–2 to 1). This uneven rotation produces a shearing action which facilitates mixing. The further processes of manufacture may vary. Usually the paste is subjected to a final rolling.

Final rolling. This operation aims at obtaining a uniform translucent, completely colloidal mass in the form of a flat sheet. It is conducted at an elevated temperature (70–95°C), and consists of repeatedly passing a sheet folded in various directions between the rolls. Calanders are usually used for the final rolling (Fig. 260). They have a highly polished surface and the spacing between them may be regulated with a high accuracy (to 0.05 mm).

Rolling is considered to be complete when the sheet is quite uniform to the eye, translucent and without streaks or stains. In some factories during the final rolling a weighed amount of centralite is added, spread over the sheets during rolling.

Both cylinders should run at the same speed. This increases the safety of the process by minimizing the friction. In spite of this the operation of final rolling is considered relatively dangerous (see p. 651).

Cutting. Warm sheets (at about 50°C) are cut on a guillotine into squares, by first cutting the sheet into strips and afterwards, crosswise, into squares. The sheets

must be warm in order to keep them plastic, so that they are easy to cut. Cold sheets, which are hard and brittle, soon blunt the knives, the cut flakes are not sufficiently regular in shape, and more dust is produced.

Ballistite is usually cut into "squares" with sides ten times larger than their web thickness (e.g. flakes of $1 \times 10 \times 10$ mm or $3 \times 30 \times 30$ mm are obtained). The

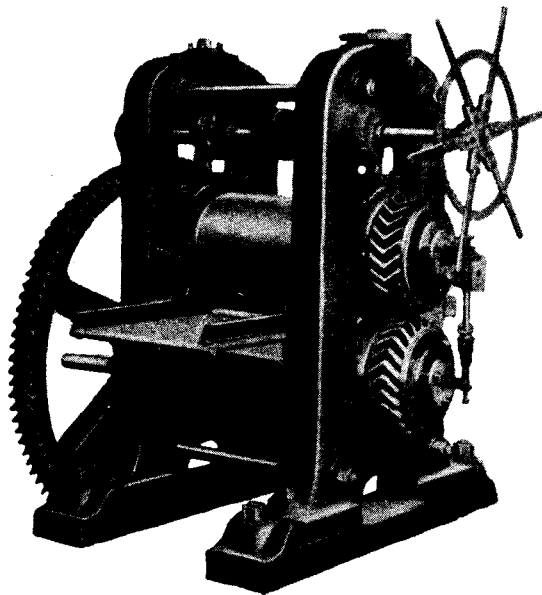

FIG. 260. Finishing rolls (calanders) [7].

dimension ratio may, however, be varied, e.g. for sporting ballistite, requiring a high vivacity, the dimensions are $0.1 \times 1.5 \times 1.5$ mm.

Grading. After they are cut, the powder flakes are graded on vibrating screens to separate out flakes of the right size from dust and coarse or irregularly shaped flakes. The waste material is returned to the dried mass prior to final rolling.

Graphite glazing. The ballistite flakes are glazed with graphite in drums. For this purpose 0.1% graphite is added to the powder and the drum is rotated for 15–30 min. The powder is then regraded, mainly to remove any graphite adhering to the surface of the flakes and the dust formed when the sharp edges of the flakes are rounded off, and is then ready for use. Its ballistic properties are tested and the mass is blended in hoppers or drums.

The method for the manufacture of ballistite outlined above gives good results only when totally soluble nitrocellulose is used, the solutions of which are not too viscous. A high viscosity hampers gelatinization while a low viscosity gives solid solutions that are too brittle. This makes the sheets brittle, causes a larger amount of wastage on cutting and impairs the strength of the flakes, which may be damaged

during transport. It is of great importance, therefore, that a plant manufacturing ballistite should always use nitrocellulose of the same properties, especially as far as solubility and viscosity are concerned.

Some factories (e.g. in Austria) which before and during World War I encountered many difficulties in manufacturing ballistite by the method described above modified the process: after the mass had been rolled to dry it, it was transferred to kneaders and a small amount (2-8%) of acetone was added. This greatly facilitated the next, final rolling which could be then conducted at a lower temperature (70°C).

The powder so obtained contained some acetone which did not volatilize on final rolling. After cutting, grading, glazing and final grading, therefore, it had to be dried at a temperature of 40-43°C, which took up to two days.

Ballistite is virtually non-hygroscopic and is therefore transported and stored in tightly closed wooden boxes, lined with cloth or waxed paper with a lid fixed with brass screws.

Attenuated ballistites

In some countries, especially during World War I when nitroglycerine was in short supply, it was partly replaced by aromatic nitro compounds, e.g. liquid DNT (a liquid mixture of DNT and TNT isomers). Partial replacement of nitroglycerine by nitro compounds also reduced the erosive effect of the powder by lowering the heat of explosion and the flame temperature during explosive decomposition.

The composition of such flake ballistite WP (Würfelpulver) was:

Collodion cotton	61%
Nitroglycerine	20%
TNT	15.25%
DNT	3.50%
Centralite	0.25%

Another type of attenuated ballistite (WP) containing less nitroglycerine and an increased content of nitrocellulose was also produced in Germany. It consisted of:

Nitrocellulose (12.6-12.7% N and 50-70% solubility)	60%
Nitroglycerine	40%

To this mass 0.5-1.0% centralite was added.

During World War I and later attenuated ballistite (Ballistite ATT) in which the nitroglycerine was partly replaced by DNT was used in France. To prevent excessive attenuation the collodion cotton was partly replaced by high nitrated nitrocellulose (CP₁):

Nitrocellulose (CP ₁)	30%
Collodion cotton (CP ₂)	30%
Nitroglycerine	25%
DNT	15%

In this case DNT also acted as a stabilizer.

Progressive ballistite

To obtain ballistite with a more progressive rate of burning, attempts were made to produce laminated flakes, with the two outer layers made of attenuated ballistite and an inner one, sandwiched between, made of ordinary ballistite. In the attenuated ballistite DNT was substituted for part of the nitroglycerine. However a powder of this type retained its ballistic characteristics for only a few months, since, due to diffusion, the composition of all three layers gradually became equal.

Safety in the manufacture of ballistites

Final rolling is a dangerous stage of the manufacture, since the powder may ignite, especially when it is rolled to a low web thickness (below 1 mm). Ignition may be caused in various ways. Sometimes a foreign body (e.g. a grain of sand) can increase friction, or a pocket of air confined in a fold of the sheet may be violently compressed when the latter is introduced between rolls.

A hot sheet of powder burns very fast. Special automatic installations are used to extinguish fire as soon as possible with a strong jet of water. The simplest system consists of suspending above the rolls a vessel filled with water which is balanced with a strip of smokeless powder. The strip is burned out at once, by the flame that shoots upwards when a sheet ignites, and the vessel immediately falls over and pours its contents onto the fire.

This equipment, however, may not apply the water quickly enough if the sheet does not burst into flame immediately below the strip of powder.

A more modern installation comprises a system in which a photoelectric cell detects the first flash of flame emitted by the sheet of powder. The electric current generated by the photoelectric cell passes through an amplifier and ignites a charge of 2 g of smokeless powder which a quarter of a second after the accident opens a 9 in. dia. water release valve. This method has proved reliable and very useful in industrial practice [36].

All workers must wear special clothes of heavy wool, leather or asbestos to protect them from brief but very hot flame. Hands must be protected with gloves that leave the fingertips bare so that the workers retain the sense of touch in the fingers, otherwise the hand may be drawn between the rolls.

In the course of their work the staff are exposed to the risk of inhaling nitroglycerine vapours but most people grow accustomed to this without detriment. The centralite vapours present in the air also exert an irritating effect upon the upper respiratory tract and it is advisable, therefore, to provide the staff with light respirators containing cotton wool or an adsorptive layer.

SOLVENTLESS POWDERS WITH A LOW CONTENT OF NITROGLYCERINE

Powder with a low content of nitroglycerine is simply called solventless powder to distinguish it from ballistite.

Solventless powder is usually tubular. It was first produced at the Düneberg factory, in 1912, under the name of RPC/12 (Rohrenpulver mit Centralit 1912). Initially the manufacture of this powder was based upon the use of easily soluble nitrocellulose (11% N), plus guncotton to bring the total nitrogen content up to 11.7%. About 25% nitroglycerine was used plus a large quantity of centralite (4-5%) as a non-volatile solvent.

The manufacturing process was divided into the following stages:

- (1) Preparation of the mixture of ingredients;
- (2) Rolling, to promote drying and gelatinizing;
- (3) Hot pressing (at 90°C) into tubes.

Since the powder contains no volatile solvent it does not require long drying (cf. the manufacture of cordite). Drying lasts only a few hours and its purpose is solely to equalize the moisture content in the powder tubes.

The rapid manufacture of RPC/12 powder was one of reasons for the protracted resistance of the Central Powers during World War I. The lack of acetone suffered by the Central Powers at that time had no effect on the production capacity of this powder in German factories.

Another of its advantages was that various substances, e.g. flash-reducing compounds, could be introduced into the powder mass. During World War I potassium oxalate or potassium tartrate were used to reduce or suppress flash. These salts cannot be introduced into nitrocellulose powder since they would be washed out with the water during soaking.

Potassium hydrogen carbonate and vaseline were also tested as flash reducing agents and stabilizers.

Powder of the RPC/12 type proved not very erosive, no more so than common nitrocellulose powders. The only disadvantage of this powder is that it is hazardous to manufacture. Rolling and hot pressing often leads to ignition. This has caused a large number of explosions. The manufacture of this powder was kept secret and not disclosed until after World War I, when the essential features of its production were revealed. The type of nitrocellulose used for the manufacture of the powder is of great importance. Mixed nitrocellulose is required since more uniform tubes are then obtained, and the presence of non-gelatinized guncotton facilitates ignition and increases vivacity. A powder made from one type of nitrocellulose containing 11.7% N is irregular, less vivacious and ignites with greater difficulty, hence its ballistics are less uniform. The uniform ballistic properties of RPC/12 powder were achieved by accuracy in production and particularly by strict production control in terms of the heat of explosion. This property was therefore kept within narrow limits.

After World War I the manufacture of solventless powder was started in other countries: France under the name of powder SD (sans dissolvent), Great Britain as Cordite SC (solventless cordite) and the U.S.S.R.

According to Wheeler, Whittaker and Pike [37] British solventless powder consisted of:

Nitroglycerine	41%
Nitrocellulose	50%
Diethyldiphenylurea	9%

At that time the composition was improved by the addition of a small amount of graphite which acts as a lubricant and so facilitates extrusion. In many cases centralite was replaced either by Acardite or by phenylethylurethane or diphenylurethane. In Japan formyldiphenylamine was applied.

In the U.S.S.R. a type of solventless powder was introduced in which organic nitro compounds, e.g. DNT, partly replaced the nitroglycerine. DNT acts as a non-volatile solvent and as a stabilizer. Since it also reduces the heat of explosion these powders are either flashless or partly so.

During World War II large quantities of flashless powder containing nitro-diethyleneglycol and nitroguanidine were produced. Nitroguanidine has the advantage of considerably reducing the heat of explosion, although it cannot dissolve nitrocellulose and is, therefore, only mechanically incorporated into the colloidal mass.

Two operations in the manufacture of solventless powder are of particular importance:

- (1) Careful mixing of the ingredients.
- (2) Uniform, hot pressing of the powder tubes.

Mixing. Mixing is conducted first by making a slurry of the nitrocellulose in water and then stirring in the nitroglycerine in which the centralite is dissolved. When, however, solventless powder is prepared with a small amount of nitroglycerine, the "paste" obtained is not sufficiently uniform in spite of continuous stirring. Uniformity is adequate, if the mixture is to be made into ballistite, i.e. if the content of nitroglycerine is relatively large (40–50%). The manufacture of the powder is then concluded by rolling and cutting the sheets. If however, the nitroglycerine content is relatively low (20–30%) and the sheets are to be extruded into tubes, the primitive method described above gives insufficient uniformity and this is not improved by mixing in kneaders. The most effective method is to allow the paste to stand in a wet condition (after removing the water by filtering or centrifuging) for some time, usually two weeks. In this "ripening" period, the composition of the mass is partially equalized by the diffusion of liquid nitroglycerine, the swelling of the nitrocellulose and its partial dissolution in the nitroglycerine.

It is obvious that this method has some serious disadvantages:

- (1) The manufacturing process is considerably prolonged.
- (2) Large concrete pits must be installed for storing the ripening paste.

The difficulties in obtaining a uniform paste were completely eliminated when nitroglycerine or dinitrodiethyleneglycol was used in the form of an aqueous emulsion for mixing with nitrocellulose under water (see pp. 647 and 661). Nitrocellulose adsorbs nitroglycerine very uniformly from an aqueous medium, so the paste thus obtained may be utilized for further processing immediately after the removal of water. This is best achieved in centrifuges. They reduce the water content to about 30%, while for further reduction (to 8–10%) screw presses are preferable.

Rolling. The paste intended for the manufacture of solventless powder is first rolled between drying rollers (at 50–60°C) and then between gelatinizing rollers, as in the manufacture of ballistite. This operation must be very carefully controlled.

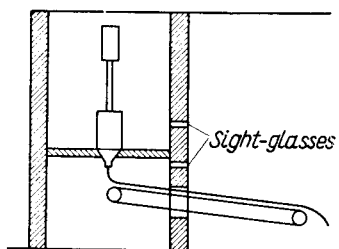

FIG. 261. A press for the extrusion of solventless powder tubes.

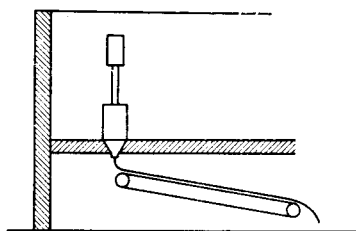

FIG. 262. A press for the extrusion of solventless powder tubes.

The powder paste should always contain the same proportion of water. The rollers used for a given powder paste should always be heated to the same temperature and their peripheral speed should also be constant (the diameter of the rollers should be directly proportional to their angular speed). The distance between the rollers, the amount of material to be rolled and the number of passages between the rollers must not be changed during the operation. Rolling of the paste should be more prolonged than with ballistite, since this improves the uniformity of the tubes extruded by the press, and gives them a smoother surface. An increase in the number of passages, however, may lead to difficulties in pressing, primarily in an increase of the pressure required for pressing since the paste becomes more gelatinized.

Powder containing dinitrodiethyleneglycol is much safer to roll than that containing nitroglycerine powder.

Pressing. This is an operation of the greatest importance since the quality of the powder tubes and their ballistic properties depend to a high degree on its proper execution. It should be carried out under a uniform but moderate pressure to give tubes with an even, smooth surface, and identical dimensions.

The tubes are extruded from the hot material, under high pressure (200–700 kg/cm²) using hydraulic presses, with the cylinders heated with hot water to a temperature of 90°C. Since the pressing operation is rather dangerous and sometimes leads to explosion, the cylinders are usually fairly small and hold at most 10–25 kg of paste. As a safety precaution the press should be separated by a wall from the conveyor

receiving the extruded tubes (Figs. 261 and 262). In addition, the press itself may be fitted with safety devices protecting it from explosion. There are presses, for example, in which the die is joined to the cylinder by crocodile clips. If the pressure inside the cylinder increases to above 1200 kg/cm^2 it exceeds the mechanical strength of the clips so that they are broken, the die is thrown out and the gases inside the cylinder can expand freely.

The causes of explosions during the pressing of hot, solventless powder have not yet been fully explained. They may include: discharge of electricity accumulated

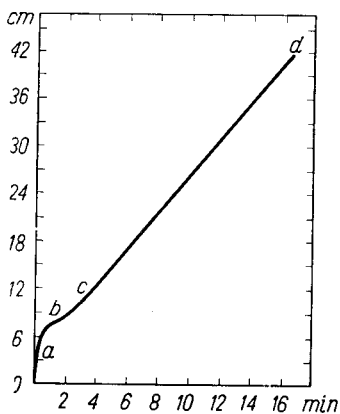

FIG. 263. Piston speed during pressing.

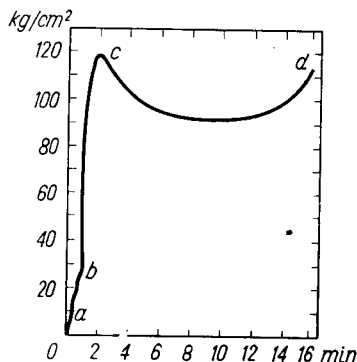

FIG. 264. Hydraulic pressure in terms of time.

by intensive friction, friction itself, and compression of hot air present between the layers of paste. Fleury [38] suggests that almost all the piston work is converted into heat energy which may lead to local overheating, up to the initiation temperature of the mass.

In fact, the material is pressed at such a high temperature that explosive ingredients particularly sensitive to friction and impact such as nitroglycerine and nitrocellulose may be exploded by a minute initiating thermal or mechanical impulse.

The mechanism of the pressing process should be known in great detail in order to recognize the dangerous moments. Fleury [38] investigated the pressing of solventless powder, and recorded the following:

- (1) A diagram of the piston speed (Fig. 263).
- (2) A diagram of the variation of hydraulic pressure with time (Fig. 264).
- (3) Diagrams of piston acceleration (curve V in Fig. 265) and of piston work (curve P in Fig. 265).

Two distinct sections ab and cd of different piston speed can be seen in Fig. 263. The speed for the first section ab is distinctly high. This is followed by a short, transitory section bc , that passes into the third section cd in which the speed becomes steady. The diagram in Fig. 264 shows that from the point b a sudden rise of pressure begins and persists for the first two minutes, while curve P in Fig. 265 shows that

during the first 30 sec the piston work increases violently with intense heat emission and then falls almost to zero, soon increasing again. These changes correspond to the following stages: first the kneading of the mass continues for half a minute,

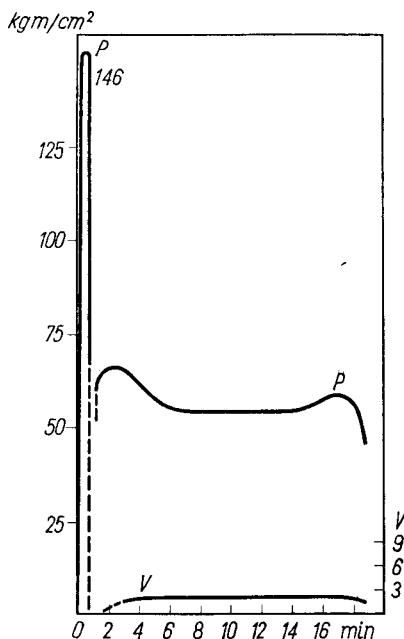

FIG. 265. Piston work in terms of time P ; V —acceleration of piston motion.

when the piston is slowed down, since the pressure is still too low to cause the outflow of the mass through the die. Next the pressure increases and the mass commences to flow out.

Fleury used the above diagrams to explain some explosions which occurred in an experimental factory at Sevran-Livry, in September and October, 1929.

In all these accidents the explosions occurred during the first stage of pressing (points b on diagrams in Figs. 263 and 264), when the pressure (*ca.* 40 kg/cm²) was considerably lower than the maximal one, but when the piston speed was fairly high (section $a-b$ in Fig. 263) and the amount of heat from the transformation of its work into heat energy was very large (curve P in Fig. 265).

Fleury concluded that it is necessary to determine experimentally the most appropriate piston speed for a given press and a given powder mass. During the whole process the speed of the piston should be so adjusted as not to produce an excessively large quantity of heat that might lead to an explosion. The danger is particularly great during the initial period of pressing since the quantity of heat than produced may be exceptionally large.

The most important factors influencing the pressing process are listed below.

Uniformity of the paste is a prerequisite for good pressing. This depends chiefly on the uniformity with which the ingredients are mixed under water and on the uniform gelatinization of the mass between the rollers. Insufficient accuracy or defective execution of either operation can be highly detrimental to the pressing process, sometimes rendering it impossible.

In addition the results of pressing also depend upon filling the cylinder with the sheets of gelatinized substance as completely as possible and upon the maintenance of a uniform temperature inside the cylinder (for nitroglycerine pastes about 90°C, for nitrodiethyleneglycol pastes about 70°C). The cylinder is properly filled by competent loading. There are two methods which differ in economy of materials. In the first method disks with a diameter equal to that of the inner diameter of the cylinder are cut from a sheet and are then piled onto each other ("sandwich loading"). In the other method the sheet is coiled into a rouleau (roll) with a diameter as above ("carpet loading"). The first of these methods is less economical since cutting the disks from the sheet leaves a considerable amount of waste clippings. Although they are recycled for rolling, this leads to an increase of running costs. Carpet loading gives only an insignificant quantity of clippings, when the edges are cut from a big sheet, and this method is therefore the more widely used.

To maintain a steady and uniform temperature within the cylinder the surface of the disks or rouleaux must not be allowed to cool during cutting or other operations preceding loading. To prevent such cooling, in many factories the powder sheets are cut or rolled on tables heated with hot water and the material is then immediately loaded into the cylinders of the press. If the disks or rouleaux should happen to cool down, the tubes extruded by the die are uneven, often shredded, and should be rejected.

Uniformity of pressure depends upon the uniformity of the charge in the press. The amount of pressure applied depends on a number of factors. For example, a higher temperature of the paste enhances its plasticity thus facilitating extrusion and making it possible to carry out the pressing under a lower pressure.

On the other hand there are a number of factors which lead to an increase in pressure, i.e.: a reduction in the dimensions (diameter) of the openings of the die, an elongation of the outlets of the die or a large number of passages between the rollers as described above.

The pressure is also greatly influenced by the composition of the powder mass, in particular by the nitrogen content of the nitrocellulose. The highest pressure should be applied to nitrocellulose with a 12.0–12.3% nitrogen content. With a lower or higher nitrogen content a lower pressure is required. An increase of the content of gelatinizing agent (e.g. over 9% centralite) may also involve increased pressure during the pressing operation. Similarly the pressure increases when a paste with a larger content of nitrocellulose is used.

However, the pressure may be considerably reduced by the addition to the powder mass of substances such as graphite, or magnesium oxide, or both, that act as a lubricant by reducing the internal friction. The presence of graphite also diminishes

the danger of electrification of the powder tubes during extrusion. Pressing is also facilitated if a certain percentage of water is left in the sheets coming from the rolls.

The uniformity (smoothness) of the surface of the tubes extruded by the press is favourably influenced by the following factors:

An increase in the number of passages in rolling;

An increase in the length of the die.

The use of nitrocellulose with a nitrogen content below 12% also increases the smoothness of the surface of the tubes. The addition of higher nitrated cellulose is not detrimental in this respect if the production process is well managed.

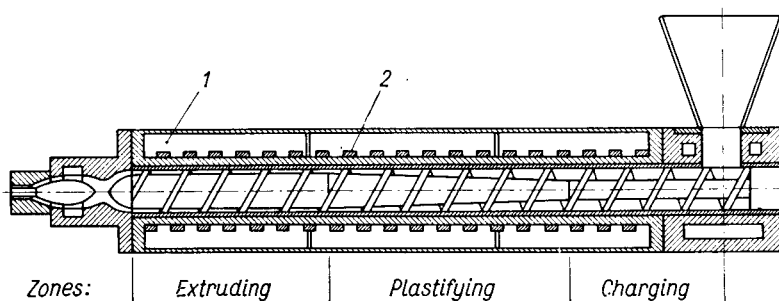

FIG. 266. Diagram of a screw press, according to Schenkel [40]. 1—heating and cooling jacket, 2—heating elements.

The surface becomes less smooth due to:

- (1) An increase in the extrusion speed of the tubes;
- (2) A rise in temperature of the mass in the cylinder.

The surface of the tubes often loses smoothness if the centralite content in the powder is increased above 9%, while it is improved when the content of nitrocellulose is increased above 50%. It was ascertained experimentally that a well gelatinized paste, containing 50% nitrocellulose of 12% N content may give tubes with a rough, uneven surface, while a paste containing nitrocellulose with the same nitrogen content but composed of a mixture of lower nitrated (about 11% N) and higher nitrated (about 13% N) nitrocellulose gives a smoother surface.

The outer diameter of the tubes extruded by the die is somewhat larger and the inner diameter somewhat smaller than the corresponding dimensions of the die. This is due to the fact that the paste is to a certain extent elastic and therefore expands after the pressure is discontinued. The shorter the die, the greater the expansion, but a longer die requires a higher pressure. Thus, under a pressure of about 230 kg/cm², with a die about 1 mm long, the tubes may expand by about 12%. When using a considerably longer die—about 25 mm—the pressure must be raised to approximately 400 kg/cm² for the same paste, to obtain the same speed of extrusion of tubes. Under these conditions, the expansion barely amounts to 5% (the above figures relate to a definite type of powder only—they may differ for other types).

The expansion of the tubes also depends on other factors. It increases with an increase in the speed of extrusion, a rise of temperature of the mass in the cylinder, and an increase in its centralite content. An increase in the number of passages between the rollers may also lead to a greater expansion of the tubes. The expansion also depends on the nitrogen content in the nitrocellulose, being nearly inversely pro-

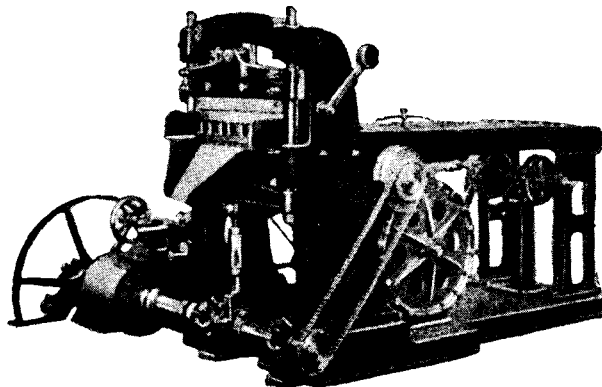

FIG. 267. "Guillotine" cutter for powder tubes [7].

portional to it. Thus, when using nitrocellulose which contains approximately 11% N, the expansion is much greater than with nitrocellulose which contains 12.3% N.

The uniformity of the diameter of the powder tubes is also influenced by different factors. Greater uniformity is obtained with longer dies and an increased number of passages between the rollers. A decrease in the nitrocellulose content to 50% reduces the uniformity of the tube dimensions as does an increase in the centralite content.

Recently a new technique of extrusion of solventless powder dough was introduced, in which extrusion is effected by a worm screw extruder instead of a hydraulic press.

A few patents have been issued covering the use of screw presses [39], but they do not include details of the design of the presses. However these do not differ from the screw presses widely used for extrusion of plastic rods, tubes and other shapes. A detailed description of the screw presses used in plastics technology can be found in monographs [40, 41]. A diagrammatic representation of a screw press is given in Fig. 266.

Cutting. Tubes extruded as described above are cut on a "guillotine" (Fig. 267). The powder should be warm when cut (about 50°C), and the trough of the guillotine is therefore heated externally with warm water. This makes it possible to maintain an adequate temperature and elasticity of the powder and prevents it from cooling down and cracking when being cut.

THE MANUFACTURE OF SOLVENTLESS POWDER IN GERMAN FACTORIES [42]

Notation

German nitroglycerine powders were all marked with letters Ngl. at the beginning of the code name. This was followed by letters denoting the form, e.g. R.P. for tubular powder, Bl.P. for square plates powder etc., as described earlier (nitrocellulose powder, p. 572). After that a figure denoting the calorific value in hundredth of kcal/kg was given, followed by the dimensions in brackets. E.g. Ngl. Bl.P.-12,5-(4·4·1) meant: nitroglycerine powder in square plates with a calorific value 1250 kcal/kg and the dimensions 4 mm × 4 mm × 1 mm; Ngl. R.P.-8,2-(100.2/1) meant: nitroglycerine tubular powder of 820 kcal/kg, 100 mm long, with external and internal diameters 2 and 1 mm, respectively.

Diglycoldinitrate powders had the same notation as nitroglycerine powders with only one difference, the calorific value was marked with letters for the sake of secrecy.

The letter A denoted calorific value 930 ± 25 kcal/kg

E denoted calorific value 740 ± 10 kcal/kg

K denoted calorific value 690_{-10}^{+40} kcal/kg

G denoted calorific value 690_{-10}^{+20} kcal/kg

E.g. Digl. R.P.-G. followed by dimensions in brackets meant diglycoldinitrate tubular powder of calorific value 690_{-10}^{+20} kcal/kg.

DGDN powder usually contained flash reducing salts. Their quantity was indicated by a figure following the letter denoting the calorific value, e.g. G.0. meant no salts are present, G 1,5 denoted 1.5% salts.

Flashless powder containing nitroguanidine was called "Gudol Pulver" and was marked with an abbreviation Gu. This was followed by the usual notation giving the form of the powder grain. Next was the letter giving the calorific value (usually A in nitroguanidine powders) followed by a figure indicating the amount of flash reducing salts. The absence of such salts was indicated by O; e.g. Gu.Bl.P.AO meant Gudol square plates powder, calorific value 930 ± 25 kcal/kg, without flash reducing salts; Gu.R.P.A. 1,2 meant Gudol tubular powder, of 930 ± 25 kcal/kg with 1.2% flash reducing salt.

Manufacture

The following method has been described as that used in Krümmel and Düneberg during World War II. First the crude powder paste was prepared. The ingredients comprised (weight of dry substance):

Nitrocellulose	70%
Explosive oil (nitroglycerine or nitrodiethyleneglycol or nitrotriethyleneglycol or nitrometriol)	30%

The nitrocellulose used for the manufacture of the mass consisted of a mixture of two qualities: high-nitrated nitrocellulose S (13.15–13.25% N), with a solubility of about 10% and a degree of fineness of about 85 cm * and low-nitrated nitrocellulose EH (11.3–11.45% N), with a solubility of 100% and a degree of fineness of about 90 cm.

For nitrocellulose supplied in hermetically-sealed containers (35–10% of water) the water content was determined by drying for 12 hr at a temperature of 45°C. Both

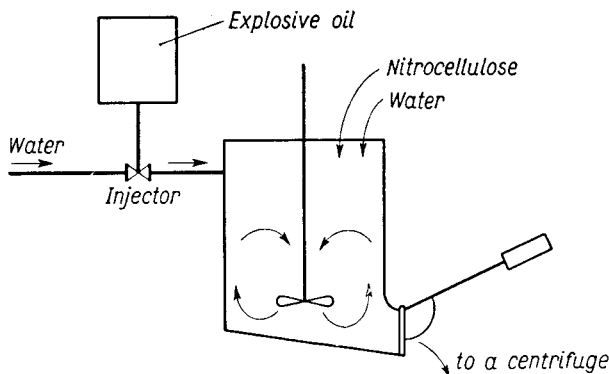

FIG. 268. Schematic view showing an arrangement for mixing powder with an injector for producing the explosive oil-in-water emulsion.

types of nitrocellulose were then mixed to obtain the required nitrogen content. In Krümmel, mixtures were used with the following nitrogen contents:

I	11.5% N	IV	12.6% N
II	12.0% N	V	12.75% N
III	12.2% N	VI	13.0% N

Mixtures II, IV and VI were used most frequently.

The nitrocellulose was weighed in rubberized bags and conveyed by electric trucks to the mixer.

The explosive oil (usually dinitrodiglycol) was used in the form of an aqueous emulsion. It was drawn from a wooden container lined with lead and introduced through a feeder into a water injector in which the aqueous emulsion formed. This emulsion was introduced into the mixer, filled with an aqueous suspension of nitrocellulose (Fig. 268).

Incorporating. Approximately 1.6 m³ of water and 280 kg of nitrocellulose (weight of dry substance) were poured into a mixer 3 m³ in capacity and a mechanical stirrer was set into vigorous motion. After 10 min of stirring, when both modifications of nitrocellulose were uniformly incorporated and a slurry was formed in water,

* The figures characterize the volume of a layer of nitrocellulose settling from a suspension of 10 g in 250 ml of water. The finer the nitrocellulose the smaller the figure.

120 kg of the aqueous emulsion of explosive oil was introduced. The whole was stirred for a further 10 min and then poured into a centrifuge. After centrifuging the paste contained about 35% of water. The centrifuge discharged its contents from below into rubber bags which were placed into larger cloth sacks and transported by electric trucks to the store where the crude paste was kept.

The water flowing from the centrifuge was collected in large tanks in which particles of crude paste carried out with the water settled on the bottom. The clear

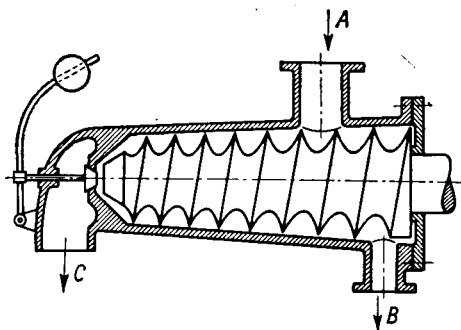

FIG. 269. Worm drying and mixing machine: *A*—inlet for introduction of dough with a 30% water content, *B*—water discharge outlet, *C*—exit for the mass containing 8% water.

water was returned to the mixer and the sediment from the bottom of the tanks was removed from time to time, when larger amounts had collected.

Storage. The crude paste was emptied out of the bags in thin layers into large wooden boxes of 10,000 kg capacity. To attain a uniform sample, the mass for processing into powder was taken in vertical layers.

The crude powder paste was conveyed to the adjacent factory in Düneberg, where it was processed into charges ready for use in the following way:

To make the crude paste uniform in composition it was mixed in a large wooden drum and loaded into Werner-Pfleiderer kneaders heated to about 50°C. The remaining ingredients of the powder (Centralite or Acardite, graphite, magnesium oxide etc., depending on the type of powder) were then added. From the kneaders the mixture was placed in air-tight cans. To ensure good results in subsequent operations, the paste was allowed to ripen for about a week. After ripening the mixture may be rolled, but its moisture content should first be reduced from 30 to 8% by passing it through a worm press (Fig. 269) to facilitate subsequent rolling operations.

Rolling. It was carried out using horizontal rollers 40 cm dia. and 100–120 cm in length, rotating with a speed of 11 r.p.m. For paste made with dinitroglycol it was sufficient to maintain a temperature of 70–80°C. A charge of about 15 kg was rolled for 18–30 min. The sheets issued from the rollers completely gelatinized. In cannon powders 3–5% water was left in the sheets since this facilitated the formation of tubes.

To load the press one or two sheets, with the edges evened-off, were coiled around a brass rod approximately 4 cm dia. This gave charges of 15–30 kg which were placed into the cylinders of a hydraulic press. The diameter of the cylinders ranged from 17–24 cm, and the temperature when pressing dinitrodiglycol powder was 70–80°C.

For pressing powder of large dimensions the Mamut press was used. This had a cylinder with 52 cm dia., a charge height of 65 cm and a charge weight of 210 kg. The pressure applied was 60–70 kg/cm². If the powder extruded was damp (3–5% of moisture) it had to be dried to 1.0–1.2% moisture content.

SOLVENTLESS POWDER IN JAPAN

The manufacture of solventless double base powder began in Japan in 1924.

It appears that the Japanese Army and Navy used two types of double base powders [33] (Table 186).

TABLE 186

Ingredients	Names	
	G OTSU Mk I	G OTSU Mk II
Nitrocellulose	63.9–64.3 (11.85% N)	58.9–59.3 (12.79% N)
Nitroglycerine	27.0	35.0
Centralite	4.0	2.5
Formyldiphenylamine	4.0	2.5
Inert compounds in proportion:		
Ammonium oxalate 50	1.1–0.7	1.1–0.7
Sodium bicarbonate 50		
Graphite 10		
Properties		
Heat of explosion (kcal/kg)	726–734	960–967
V_0 (l./kg)	979–980	892–893
t (°C)	2410–2427	3006–3025
f (m)	9946–10,016	11,077–11,148

Powder G OTSU Mk I was designed for general ordnance use. It was characterized by low corrosion.

Powder G OTSU Mk II was mainly used in naval revolving turret guns.

FLASHLESS CHARGES AND FLASHLESS POWDERS

The first flashless charges were made during World War I. They were developed from an observation of Dautriche [43] that addition of blackpowder reduces and attenuates flash or even entirely prevents the formation of a secondary flame. The French therefore added blackpowder to nitrocellulose powder and during World War I regularly loaded part of their machine gun ammunition with a mixture con-

sisting of nine parts of smokeless powder and one part of blackpowder. In their cannon they used silk anti-flash bags filled with potassium hydrogen tartrate. Since this substance reduced the muzzle velocity, an extra charge of smokeless powder was used. E.g. in 155 mm naval guns, 305 g of BM₇ powder were added to restore the muzzle velocity to a charge of 10 kg of BM₇ powder with a priming of 115 g of blackpowder, when three bags of 500 g of potassium hydrogen tartrate were used.

Another method used in France was to add anti-flash pellets, consisting of four parts of potassium nitrate and one part of DNT, to propellant charges. The pellets weighed one gramme each and were about 2 mm thick and 15 mm dia. They were sewn in silk bags, in numbers depending on the calibre e.g. 200–300 were used for a 155 mm gun. Such pellets behaved as a propellant charge and did not reduce the muzzle velocity.

The Germans used anti-flash charges containing potassium chloride in their cannon propellants. The charges, in bags of artificial silk or cotton cloth, were loaded between the base of the projectile and the propellant. Obviously, all the additions described above increased the smoke formed when the rounds were fired.

After World War I FNH powder was produced in the U.S.A. It was flashless, and non-hygroscopic and according to one of the relevant patents [44] consisted of:

Nitrocellulose (13.15% N)	76–79%
DNT	21–24%
Diphenylamine	1%

or

Nitrocellulose	84%
DNT	10%
Butyl phthalate	5%
Diphenylamine	1%

Flashlessness was attained by reducing the heat of explosion with an addition of DNT. At the same time, however, smoke was increased.

Other patents of the interwar period include several that specified addition of substances rich in carbon, e.g. of powdered hydrocellulose, to obtain flashless charges. In the U.S.S.R. nitroglycerine powder was used in which a part of the nitroglycerine was replaced by aromatic nitro compounds. During World War II the most widely used flashless powder contained nitroguanidine (in Germany called "Gudol" powder).

The idea of adding nitroguanidine to smokeless powder had been already considered by Vieille [45]. He suggested adding nitroguanidine to reduce the erosiveness of the powder (see p. 548)

The idea was revived by various authors (e.g. Recchi [46]).

It was difficult to manufacture since the nitroguanidine had to be introduced into the powder mass in a state of fine subdivision, otherwise the powder was not uniform. In some factories, therefore, methods were worked out to obtain nitroguanidine in the form of fine dust.

The introduction of a large amount of nitroguanidine would be very difficult, were it not for the replacement of the nitroglycerine by dinitrodiethyleneglycol which

TABLE 187
FLAKE POWDER FOR TRENCH MORTARS, HOWITZERS AND FIELD GUNS [42]

No.	Purpose	Dimensions	Composition (%)														
			Nitrocellulose		Nitroglycerine	Nitrodiglycol	Nitroguanidine	Centratite	Acardite	Graphite	Magnesium oxide	Potassium sulphate	Other ingredients*	Calorific value (kcal/kg)			
				Nitrogen %													
1	8 cm trench mortar	Flakes 1 × 1 × 0.2	54.5	13.0	44.0	—	—	—	1.1	—	—	—	—	—	—	—	1250
	7.5 cm infantry gun	Rings 0.4 × 60/30	54.5	13.0	44.0	—	—	—	1.1	—	—	—	—	—	—	—	1250
	7.5 cm infantry gun	Rings 73.5 × 0.8	54.5	13.0	44.0	—	—	—	1.1	—	—	—	—	—	—	—	1250
2	10.5 cm field howitzer	Flakes 3 × 3 × 0.8	60.2	13.0	—	39.0	—	—	0.3	—	—	—	—	—	—	—	1050
	10.5 cm field howitzer	Flakes 4 × 4 × 1.2	60.2	13.0	—	39.0	—	—	0.3	—	—	—	—	—	—	—	1050
	10.5 cm field howitzer	Flakes 10 × 10 × 0.2	60.2	13.0	—	39.0	—	—	0.5	—	—	—	—	—	—	—	1050
4	Heavy howitzer	Rings 1.9 × 15/4	59.1	13.0	—	40	—	—	0.3	—	—	—	—	—	—	—	1050
5	No full information	?	63.65	13.0	—	35.8	—	—	—	—	—	—	—	—	—	—	1050
6	No full information	?	54.4	13.0	—	44.5	—	—	—	—	—	—	—	—	—	—	1050
7	No full information	?	38.0	13.0	—	31.2	—	—	—	—	—	—	—	—	—	—	1050
8	To reinforce the primer	?	54.2	13.0	44.4	—	—	—	—	—	—	—	—	—	—	—	1250

* No full information.

TABLE 188
TUBULAR POWDER WITHOUT NITROGUANIDINE FOR ANTI-AIRCRAFT AND HEAVY GUNS [42]

No.	Purpose	Composition (%)										
		Nitrocellulose		Nitrogen %	Nitrodiglycol	Centralite	Butyl phthalate	Graphite	Magnesium oxide	Potassium sulphate	Vaseline	Dimensions
1	3.7 cm anti-aircraft gun	68.2	12.0	29.2	2.2 or 1.7 +0.5 of acardite	—	0.1	0.1–0.25	0.05–0.2	—	195 × 2/0.85	820–870
2	8.8 cm anti-aircraft and 10 cm K18 heavy gun	67.65	12.0	29.0	3.0	—	0.1	0.25	—	—	490 × 4.9/2.1	825
3	8.8 cm anti-aircraft gun	64.1	12.0	27.5	5.3	0.90	0.1	0.25	—	1.85	?	730
4	7.5 cm (40) tank-mounted gun	61.5–64.1	12.0	26.4–27.0	7.5–8.0 or 9.25 and 0.8 of diphe- nylureth- ane	0.65–0.8	0.1	0.25	2.0	1.6–1.8	420 × 3.8/1.5	690–700

TABLE 189
CANNON TUBULAR POWDER WITH NITROGUANIDINE [42]

No.	Purpose	Composition (%)										Calorific value (kcal/kg)	
		Nitrocellulose		Nitroglycerol	Nitroguanidine	Ethylphenylurethane	Diphenylurethane	Acardite	Graphite	Magnesium oxide	Potassium sulphate		Dimensions
1	8.8 cm anti-aircraft gun	43.5	12	18.65	30	3.75	3.25	0.5	0.1	0.25	—	?	750
2	8.8 cm anti-aircraft gun	39.5	12	16.9	30	5.0	4.25	—	0.1	0.25	4.0	?	750

TABLE 190
TUBULAR POWDER WITH SUBSTITUTES [42]

No.	Purpose	Nitrocellulose		Composition (%)													Calorific value (kcal/kg)
			Nitrogen %	Nitrodiglycol	Nitroguanidine	DNT	Nitronaphthalene	Centralite	Acardtite	Ethylphenylurethane	Diphenylurethane	Hydrocellulose	Graphite	Magnesium oxide	Potassium sulphate	Dimensions	
1	8.8 cm anti-aircraft and other ground guns	69.7-69.9	12	14.8-15.0	-	10	2	3	-	-	-	-	0.1	0.15	-	490 × 4.9/21	690-730
2	All guns, commonly used (Universal powder)	60.55	12	25.95	-	4	2.5	3.75	-	-	3	0.1	0.15	-	-	?	730
3	Various guns	44.0	12	18.85	20.0	3.5	2.0	-	0.4	1.5	4.0	0.1	0.15	4.0	?	?	720

TABLE 191
TUBULAR POWDER FOR NAVAL GUNS [42]

No.	Purpose	Nitrocellulose		Composition (%)												Calorific value (kcal/kg)				
		Nitrogen %	Nitrodiglycol	Nitrotriglycol	Nitroguanidine	Nitronaphthalene	Centralite	Acardite	Ethylphenylurethane	Diphenylurethane	Butyl phthalate	Graphite	Magnesium oxide	Potassium sulphate	Dimensions					
1	All guns, commonly used	69.38	25.27	12.2	—	—	—	—	5	—	—	—	—	—	0.1	0.25	—	—	?	820
2	All guns, commonly used	65.5	23.9	12.2	—	—	—	—	9	—	—	—	—	1.25	0.1	0.25	—	—	?	730
3	All guns, commonly used	65.7	23.95	12.2	—	—	—	7	2.5	0.5	—	—	—	—	0.1	0.25	—	—	?	730
4	Signal rescue charges	58.55	—	12.2	—	—	—	—	12	—	—	—	—	—	0.1	0.25	4	—	?	650
5	37 cm gun SKC/32	35.5	21.75	12.2	—	—	—	—	—	0.5	0.7	0.7	—	—	0.1	0.25	0.5	—	?	820
6	Most important guns	42.45	18.2	12.0	—	—	—	—	—	—	4.5	4.5	—	—	0.1	0.25	5.0	—	?	730

imparts a higher elasticity to the powder. This enabled the "foreign" substance to be incorporated into the powder mass while retaining its crystal form.

Powder containing nitroguanidine has certain disadvantages. It is more fragile than the ordinary solventless powder, due to the presence of nitroguanidine, i.e. a substance which is not included in the powder colloid. On the other hand it has the advantage that it does not increase the smoke to a marked degree. Small amounts of other anti-flash substances such as potassium nitrate or sometimes powdered hydrocellulose are added to this powder. The compositions of powder of this type and of other solventless powders manufactured in Germany during World War II, are summarized in Tables 187-191.

In Great Britain small amounts of sodium or potassium cryolite (potassium aluminium fluoride) were added to nitroglycerine powder containing nitroguanidine. According to Pring [47] a powder with 55% nitroguanidine and cryolite gives no flash in all calibres of cannon up to 16 in. (40 cm). Charges of this powder, however, are harder to ignite and thus require a larger quantity of blackpowder as a primer. This, in turn, increases the smokiness, since the majority of smoke in firing with smokeless powder derives from the blackpowder primer.

Other substances suggested for flashless powder instead of nitroguanidine included aminotetrazole which was, however, rejected due to its hygroscopicity, and methyleneurea.

Recently it was found that caesium salts prevent the formation of secondary flame.

SMOKELESS POWDER WITH PENTHRITE

During World War II, the German tried using penthrite as an ingredient of smokeless powder. Penthrite, in spite of being a nitric ester, does not dissolve nitrocellulose and thus retains its crystal structure in the powder mass, and causes brittleness (like nitroguanidine). The introduction of a large amount of penthrite into the powder mass was possible only when dinitrodiethyleneglycol was used, which, as is known, gives a more elastic and mechanically resistant powder. Powder containing penthrite (Nipolit) has been manufactured on a small scale. The manufacture never passed beyond pilot plant scale. The production process was the same as in other nitroglycerine powders. The composition of Nipolit is given in Table 192.

TABLE 192
THE COMPOSITION OF NIPOLIT

Ingredients	Tubes	Cords
	80 × 27/9.1	50 × 9.1
Nitrocellulose (12.6-12.7% N)	34.1	29.1
Dinitrodiethyleneglycol	30	20
Penthrite	35	50
Magnesium oxide	0.05	0.05
Graphite	0.1	0.1
Centralite or urethane	0.75	0.75

SMOKELESS POWDERS CONTAINING NITROALIPHATIC COMPOUNDS

Hexanitroethane was recommended as an ingredient of smokeless powder [48]. It is a good solvent of nitrocellulose and due to its high energy of explosion it could produce a high energy propellant.

It was believed that the German Army used smokeless powder containing hexanitroethane for the long range artillery that bombarded Paris in 1915.

The complicated and costly manufacture of hexanitroethane prevented further use of this substance as an ingredient of smokeless powder.

There is now a trend towards the use of nitroaliphatic compounds more readily available from simple nitroparaffins. Thus Aerojet-General in Sacramento, California [49] suggested using a 50/50 mixture of bis-(2,2-dinitropropyl)-formal (I) and bis-(2,2-dinitropropyl)-acetal (II) as a "nitroplasticizer". The mixture of the two compounds is liquid. The products are obtained from nitroethane through the following sequence of reactions:

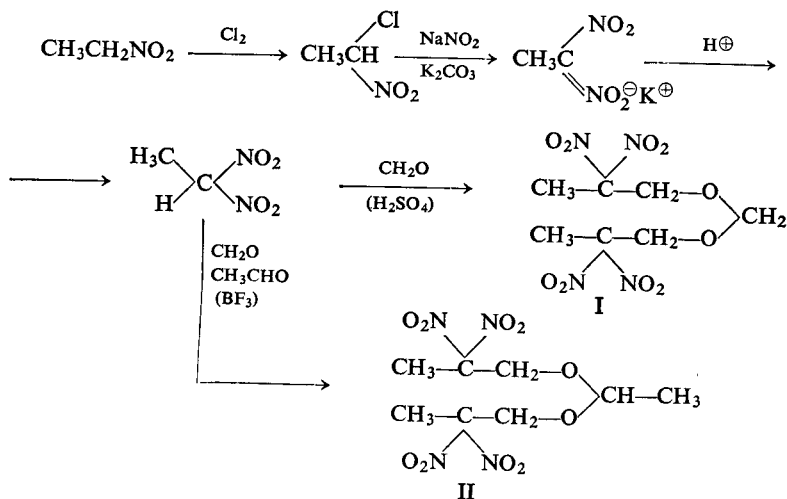

The composition of the propellant was not revealed. It is only known that the propellant contains ammonium perchlorate as an oxidizer and has a very high density.

SMOKELESS POWDERS FOR ROCKETS

In the interwar period, after 1930, a number of countries (e.g. Germany, Great Britain) began to manufacture double base powder for rockets. In Great Britain (according to Wheeler, Whittaker and Pike [37]) it was manufactured in the form of tubes 2 in., 3 in. and 4.3 in. dia. The composition of German rocket powders is given in Table 193. Tubes of larger diameter were also made.

Due to the great web thickness the burning time of the powder tubes was considerable: about 3–4 sec under a pressure of about 10 kg/cm².

In composition, nitroglycerine powder (with a relatively low content of NG or DEGN without solvent) is the same as that commonly used without a volatile solvent for firearms; it has, however, a characteristic which calls for an examination of its use for rocket propulsion.

(1) The gases evolved on burning are intensely luminous. Non-transparent dark-coloured particles, often not visible to the naked eye, e.g. undissolved nitrocellulose, fibres or various impurities which are always present in the powder grains, adsorb this radiation more readily than the colourless or light-coloured powder mass. The temperature in the neighbourhood of these dark spots is therefore higher than that in the whole mass and even may be high enough to produce ignition of the surrounding powder. This creates the danger of irregular burning at many points inside the powder mass, causing the powder grains to crack. It also causes a sudden increase in the surface of the burning grains and a rise in pressure that may lead to the explosion of the rocket (blowing out the steel rocket case). Accidents of this kind have been noted with nitroglycerine smokeless powders of a web thickness of over 15 mm. After a certain time it was found that the addition of a darkening agent prevents the premature burning of the powder mass below the surface. Nigrosine and lamp black were used for this purpose. The darkening agent finally adopted was carbon black in the extremely fine form used in the rubber industry with a grain diameter from 0.025–0.5 μ . It is added to the powder in an amount of 0.01–0.2% by weight. It is also advisable to add some graphite, as was used formerly to facilitate the extrusion of a powder mass without a volatile solvent.

(2) Powder for rockets is usually in the form of perforated grains with a large diameter, considerably larger than that of the tubes used for cannon charges. This makes the production process for extruding the powder mass very complicated.

(3) The powder in rockets burns under much lower pressure than that in firearms (usually below 2000 lb/in²) and its burning rate is also considerably lower. The low pressure and the low burning rate, together with the shape of the powder and of the combustion chamber, specific for rockets, lead to a reaction, totally unknown in firearms, called "resonance burning", which is characterized by certain periodic pressure oscillations. It may well be that this is caused by unevenness of the powder and the presence in it of droplets of nitroglycerine, which was discussed earlier (p. 647). Irregular burning may be alleviated by drilling radial holes in a spiral pattern along the length of the powder tube, or a non-combustible rod may be inserted into the perforation. This "stabilizing rod" is used in many current rockets.

Experience in using large charges of nitroglycerine powder has shown that powder tubes with a large diameter are unsafe to use due to the internal stresses which arise in them during cooling. While the powder is burning the tube may crack due to the local weakening of the walls and the pressure of the gases. The burning surface of the powder then increases, the pressure rises and the rocket may be blown up.

In small Soviet and German rockets a powder charge made of a bundle of small diameter powder tubes (e.g. to 20 mm) has been used. The internal stresses in these charges were not sufficiently strong to be dangerous.

In Great Britain and the U.S.A. cruciform, non-perforated powder grains have been used for rockets of heavy calibre. In these charges the mechanical stresses are far less important than in tubular charges. Another modification, consisting in the very slow cooling of the charges after extrusion and cutting up, necessitated new installations and prolonged the flow process, so a new method was introduced in which the charges were cast. This is discussed further on.

The composition of nitroglycerine powder for rocket propulsion is similar to that of conventional powder.

The composition of German rocket propellants manufactured during World War II are given in Table 193.

TABLE 193
ROCKET POWDER [42]

No.	Purpose	Composition (%)												
		Nitrocellulose		Nitroglycerol	Acardite	Ethylphenylurethane	Diphenylurethane	Hydrocellulose	Wax E	Vaseline	Magnesium oxide	Potassium sulphate	Dimensions	Calorific value (kcal/kg)
			Nitrogen %											
1	"Universal" powder for all rocket launchers	60.0-60.2	12.6	35.3	—	1.4	1.0	1.5	0.35	0.25	0.25	0.8	?	900
2	For 30 cm rocket launcher	59.05	12.6	34.8	0.5	1.9	—	3.0	—	0.5	0.25	—	?	865

Serebryakov [50] reported the following composition for rocket powders:
J.P.N. (U.S.A.) rocket powder consists of:

Nitrocellulose (12.2% N)	51.5%
Nitroglycerine	43.0%
Diethyl phthalate	3.25%
Carbamite	1.0%
Potassium sulphate	1.25%
Wax	0.08%
Carbon black	0.2%
Moisture	0.6%

M.R.N. (U.S.A.) rocket powder consists of:

Nitrocellulose (12.2% N)	56.5%
Nitroglycerine	28.0%

Diethyl phthalate	3.0%
Aromatic nitro compounds	11.0%
Carbamite	4.5%
Wax	0.08%
Moisture	0.6%

German powder:

Nitrocellulose (12.2% N)	64.5%
DGDN	29.0%
DNT	11.0%
Centralite	3.5%
Candelilla wax	1.0%
Carbon black	0.35%
Moisture	0.5%

According to Ley [51] British smokeless powder for 2 in. rockets consisted of:

Nitroglycerine	50%
Nitrocellulose	41%
Centralite	9%

The powder was in the form of tubes about 4 cm dia. and about 1 m long.
Japanese 10–20 cm rockets were loaded with powder consisting of:

Nitroglycerine	27%
Nitronaphthalene	7%
Nitrocellulose	60%
Centralite	3%
Potassium sulphate	4%

Much attention is now paid to the mechanical properties of smokeless rocket powder [52]. This stems from the requirement for physical integrity during manufacture, storage and firing. Any imperfection, such as a crack or deformation or a stress which may lead to a crack in the course of burning can cause serious ballistic malfunction. This defective behaviour is particularly liable to occur in large double base powder grains, hot extruded under pressure.

According to Steinberger [53] the main problems, dependent on the physical properties of the propellant, are:

(1) Thermal variations. A solid propellant grain may be exposed to temperature extremes ranging from conditions of low temperature in the upper atmosphere, to tropical heat. The grain must not be too brittle at low temperature nor too soft at high temperature. The problem can be aggravated by "case-bonding" since different coefficients of expansion of the metal-case and the propellant can produce a very harmful effect.

(2) Grain collapse. This is a problem which exists in some rockets where an appreciable pressure difference can develop between the forward and aft ends of the rocket. The latter is subjected to compressive forces which can squeeze it. A propellant of high tensile strength is therefore desirable.

(3) Grain expansion. This is the problem opposite to (2). It can be serious in some rockets. The propellant must be sufficiently flexible to accommodate expansion without cracking.

Steinberger [53] suggested that propellants for case-bonded units should possess a tensile strength greater than 50 lb/in² and elongations greater than 15%. According to Boynton and Schowengardt [54] many applications require an ultimate tensile strength of 120 lb/in² and elongation of *ca.* 30%.

The difficulty in the manufacture of large grains may be overcome by substituting the classical method for the extrusion of powder by a novel technique whereby cast charges of double base propellant are produced.

CAST DOUBLE BASE PROPELLANTS

The process consists of loading a mould with granules of nitrocellulose powder and filling the interstices between the granules with a solution of a nitroglycerine plasticizer. This causes the nitrocellulose powder to swell and to gelatinize with the ingredients of the liquid phase to form a horny solid on heating the mould.

This technique seems to have been developed in various countries during World War II.

In Germany, owing to the short supply of nitroglycerine and nitrocellulose, TNT was used as the main constituent [55] (p. 681).

The composition of various more modern cast double base propellants (according to Sutton [56] and J. Taylor [57] is shown in Table 194. Table 195 gives the physico-chemical properties of propellant I.

TABLE 194

Ingredients	Propellant numbers (given by the author of this book)			
	I	II	III "OV"	IV
Nitrocellulose	45-55	47.0	58.6 (12.6% N)	60.0
Nitroglycerine	25-40	37.7	24.2	37.8
Plasticizer (mainly dimethylphthalate)	12-22	14.0	9.6	-
DNT	-	-	6.6	-
Ethyl centralite	-	1.0	1.0	0.9
Diphenylamine	1-2	-	-	0.2
Carbon black or graphite	-	0.3	0.1	0.2

TABLE 195

Constants	Figures
Adiabatic flame temperature (°F)	2600-4000
Typical sea level specific impulse, (sec)	160-220
Burning rate of 1000 lb/in ² (kg/cm ²) and 70°F (21°C) (in./sec)	0.22-0.3
Burning rate exponent (equation $V=k.p^n$)	0.1-0.8

The main advantage of cast propellant charges consists of the ease with which very large charges may be made without very costly equipment.

The safety of the process is higher than that of the conventional extrusion process and the labour cost is relatively low.

According to Sutton [56] the amount of additives in the cast double base charges varies from 5–30%. Their object is to improve the physical properties of the powder, facilitate manufacture, confer better stability under various storage conditions, suppress flash and inhibit ignition caused by the radiation of energy through the translucent grain. According to Sutton, an increase in the nitrocellulose content of the charge usually improves its mechanical strength.

A description of the technology of the process is given below.

Technology of casting

According to published information [52, 54, 58] two methods are in use: (1) powder casting process, and (2) slurry casting.

Powder casting process. This is the most versatile process for manufacturing double base powder charges of any size and shape.

The first step consists of making a "casting powder" composed of nitrocellulose, all the solid ingredients and a part of the non-explosive gelatinizer, such as carbamite (centralite), phthalates, etc. Solvent (alcohol-ether) is added to this mixture and threads of *ca.* 1 mm dia. are made by the usual extrusion method and cut to the length of *ca.* 1 mm. The solvent is removed by drying.

This casting powder is poured into a mould with a core of the shape required for the future charge ("grain") (Fig. 270). The mould is usually lined internally with a cellulose acetate or ethyl cellulose sheet which forms the inhibitor for the finished grain, if the grain is to burn from the inside outwards (as in most solid propellant grains used in large rockets). The thickness of the sheet of inhibitor may range from 3–12 mm. The bottom of the mould may also be covered with the same material. The mould should be provided with an equipment for the evacuation and pressurization of the assembly.

The casting powder fills *ca.* $\frac{2}{3}$ of the mould. Then the inside of the mould is evacuated to remove air and residual solvent vapours.

The interstitial spaces between the granules of the casting powder are slowly filled with the "casting solvent" composed of a mixture of plasticizers such as: nitroglycerine, diglycol dinitrate and a further quantity of carbamite (centralite) and esters. Introducing the solvent too fast can disturb the packed bed of granules. Filling can be done from the top, from the bottom or radially from the core (if perforated) and the advancing solvent front sweeps out the air, which is evacuated through a vent (at the bottom on Fig. 270).

The filled mould is sealed, sometimes pressurized and placed in an oven at moderate temperature (usually 60°C) to cure for a period ranging from 8 hr to several days.

The curing action consists of diffusion of the plasticizers into the casting powder, resulting in swelling and partial dissolution of the granules, thus consolidating the whole into a reasonably homogeneous mass. This should be tested by X-ray examination before firing.

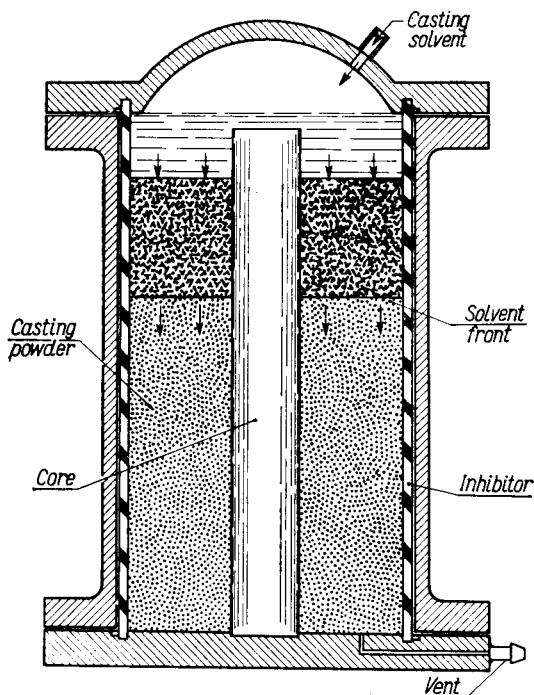

FIG. 270. Mould for casting a rocket powder grain [53].

The process has the great advantage that very large charges can be made this way. Grains up to 4 tons have been prepared.

Its main disadvantage consists in the fact that the process is slow.

Slurrying process. The main aim of this process is to avoid the necessity of making casting powder. Granular nitrocellulose is used instead, a fibrous form being unacceptable because of the high rate of swelling and solution which makes the gel insufficiently uniform.

Nitrocellulose granules, partially colloided, of sizes ranging from a few microns to a fraction of millimetres are suggested. The best known of the described methods was developed by the Hercules Powder Company [54]. It uses "densified" nitrocellulose originally developed for the lacquer industry, with an average particle size of 0.25 mm.

The basic idea of slurry casting consists of preparing the propellant in one simple mixing operation. The plasticizer is poured into a mixing pot and the solid ingredi-

ents, including the nitrocellulose, are added. The mixture is stirred for a few minutes (usually 15 min), poured into a mould or a rocket case and cured. Figure 271 gives a diagrammatic presentation of the main parts of the arrangement. When hoppers

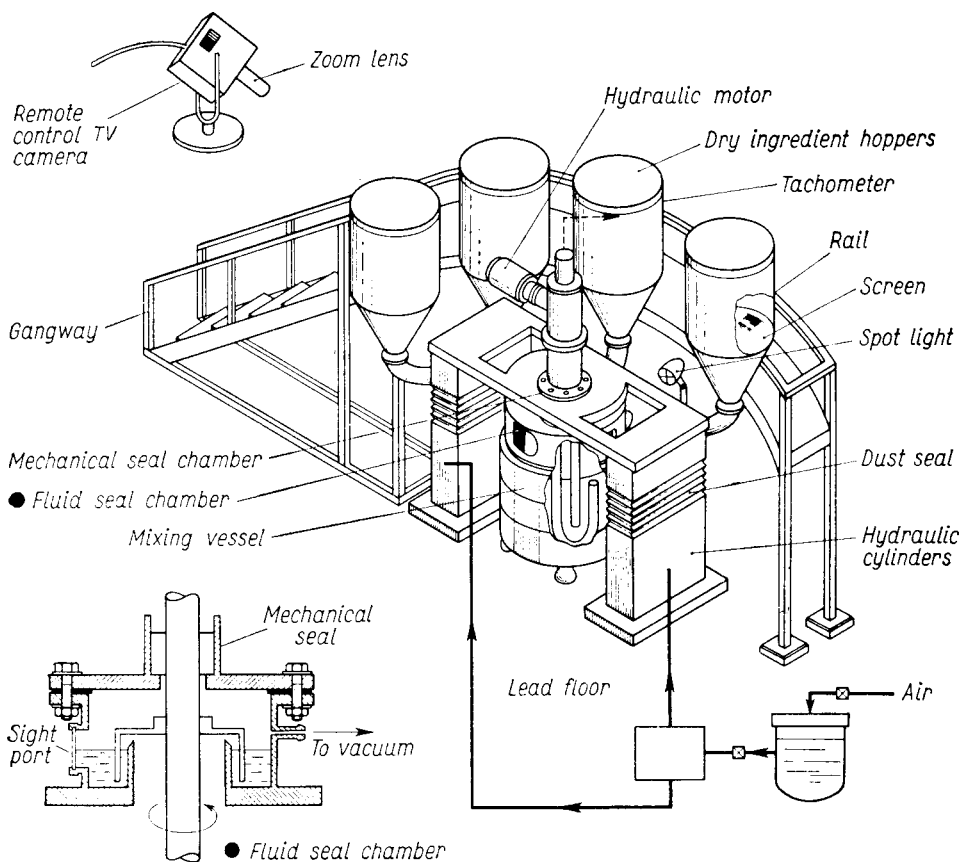

FIG. 271. Diagram of a slurry mixing arrangement at Hercules Powder Co., Bacchus Work [54].

are charged and the mixers are operated, the personnel are withdrawn from the building and all is operated by remote control.

This method can be used to make propellant charges of ammonium perchlorate, RDX, nitroglycerine and triacetate.

Physical properties of cast propellants

Steiberger [53] gives a number of diagrams which illustrate the change of mechanical properties: tensile strength, elongation and modulus of elasticity with nitrocellulose content (Figs. 272, 273 and 274). It is evident that nitrocellulose exerts a great influence on the properties of the system.

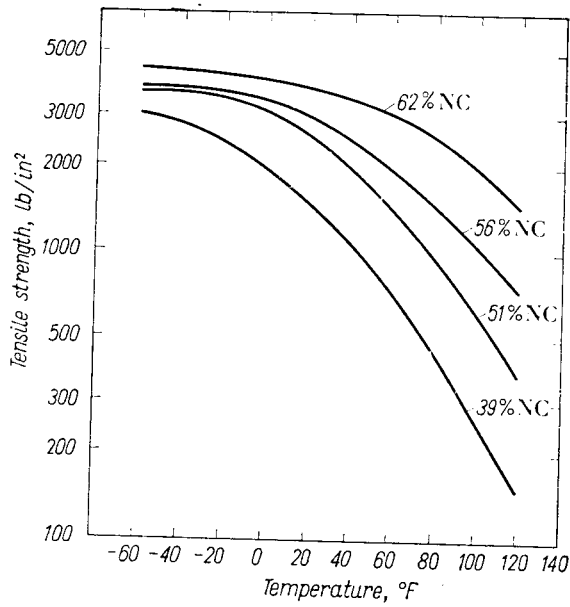

FIG. 272. Tensile strength of cast double base powder as a function of nitrocellulose content [53].

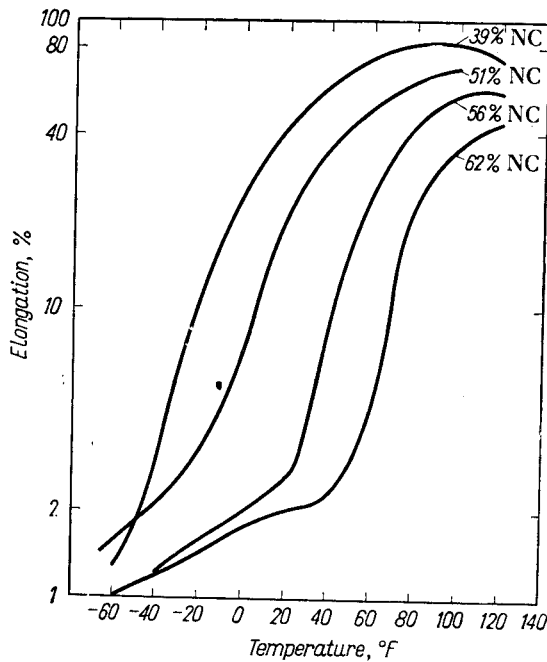

FIG. 273. Elongation of cast double base powder as a function of nitrocellulose content [53].

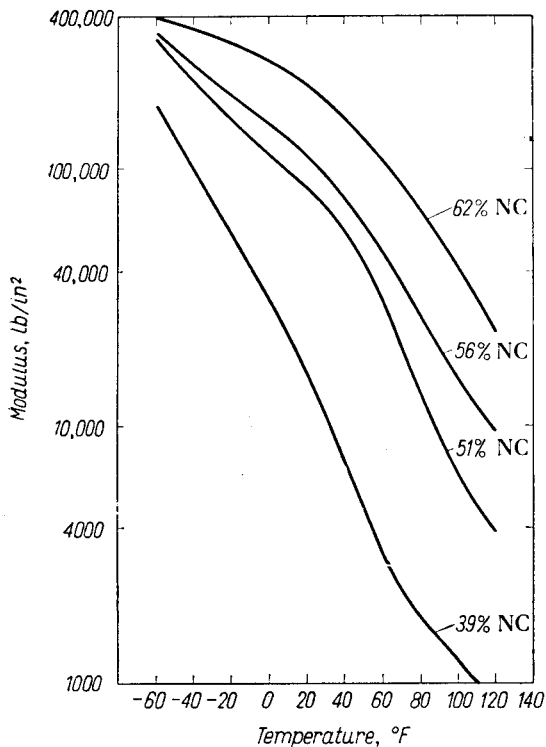

FIG. 274. Modulus of elasticity of cast double base powder as a function of nitrocellulose content [53].

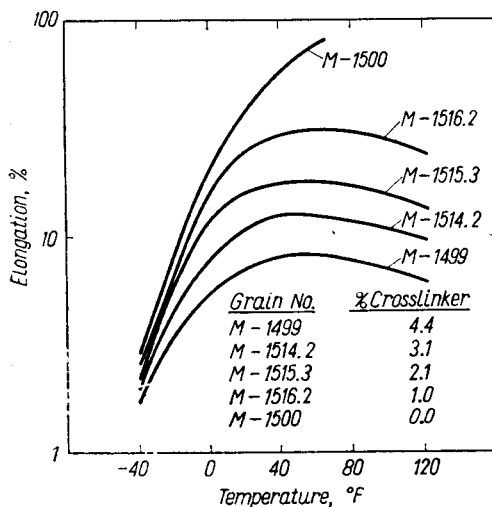

FIG. 275. Influence of cross-linking of nitrocellulose on physical properties of cast charges [53].

Variations in the viscosity of nitrocellulose have only negligible effect on the physical properties of the propellants. On the contrary, cross-linking the nitrocellulose by adding polycarboxylic acid anhydrides, di-isocyanates or metallic salts may produce a profound influence as shown on Fig. 275. Elongation is significantly decreased especially at high temperature. The modulus is increased correspondingly, while the tensile strength is unaffected. A low degree of cross-linking may be particularly beneficial, decreasing deformation or flow at high temperature while leaving the low temperature properties unchanged.

According to Boynton and Schowengardt [54] the ultimate tensile strength of double base rocket charges should be 120 lb/in² and elongation *ca.* 30%. The propellant which gives these properties contains less binder than the maximum imposed by the casting powder process, but it can be produced by the slurry process.

Grosse [55] indicated that a typical NG double base powder on static testing should produce a maximum stress of 200 kg/cm². When the loading rate is increased to 0.23 sec and 0.15 sec until fracture, the stress is 360 and 442 kg/cm², respectively.

German cast propellants for rockets

Originally this powder (Giessling Pulver) consisted of:

TNT	50-52%
Nitrocellulose	28-30%
DGDN (Diethyleneglycol dinitrate)	17-18%
Centralite	0.5%
Diphenylamine	0.5%

The propellant was in the form of tube or plain grain, the latter having a diameter up to 50 cm and a length of about 100 cm.

Finely ground nitrocellulose of low viscosity was used. It was impregnated with DGDN under water in the usual way. After dehydration in a centrifuge to a moisture content of 18-22%, the blend was stirred into molten TNT. The vat was evacuated to evaporate the water and to produce a homogeneously gelatinized grain.

These propellants had rather poor physical properties produced by a high proportion of TNT: they were too brittle and unsuitable for spin stabilized rockets.

A ridged, block-shaped propellant with nine perforations was later used for 21 cm Nebelwerfer rockets. It was 12.5 cm in diameter, about 40 cm long and weighed about 6.5 kg. Its composition was:

Nitrocellulose	63%
Diethyleneglycol dinitrate	35%
Centralite	0.5%
Wax	0.2%
Graphite	1.2%

The disadvantages of smokeless powder as a rocket propellant, the difficulty in manufacturing very large charges and the high operating expenses led to a search for explosives based upon another principle: plastomers or elastomers with an oxygen carrier.

GENERAL SAFETY CONSIDERATIONS IN THE MANUFACTURE OF SMOKELESS POWDER

The safety aspects of the manufacture of smokeless powder have already been mentioned when describing manufacturing methods.

There are however some safety aspects which can be considered in general terms. They can be classified into two main groups according to the origin of the danger:

- (1) The use of combustible solvents;
- (2) The sensitiveness of nitrocellulose or nitroglycerine and similar esters to thermal or mechanical factors or to electric discharge.

Solvents

A number of unexplained accidents were encountered in nitrocellulose powder factories associated with handling alcohol and particularly ether.

Thus, the simple opening of a valve closing a pipe bringing ether from a tank placed at a certain height may cause the ether to catch fire. Investigation of the origin of this phenomenon at the beginning of the XXth century led to the conclusion that inflammation of the ether occurred when the static charge acquired by the solvent flowing along the pipe was discharged on contact with an earthed object.

The first experimental work on the production of static charges in liquid during its flow along insulated pipes were carried out at the end of the last century [59].

Freytag [60] collected the data on the subject obtained by various authors. Some of the figures referred to solvents used in the manufacture of powders are given in Table 196, according to Dolezalek [61].

An electric discharge from other sources can also ignite solvents.

The following accident was described in a cordite factory. A worker wearing rubber shoes wanted to clean his hands which were soiled with powder dough. He rubbed his hands together and held them towards a bucket filled with acetone standing on the concrete floor. A spark between the hands and the surface of the acetone ignited the latter.

In this instance, the worker's body became charged by the friction generated on rubbing his hands. According to Freytag [60] this kind of friction may charge the human body to a potential of 10,000–14,000 V.

Because of these accidents all tanks containing solvents and all pipes were earthed. This prevented further accidents.

Another danger associated with solvents has already been mentioned (pp. 601, 607), i.e. the explosibility of mixtures of combustible vapours with air.

These mixtures can be exploded by an electric discharge or by sparks from steel tools etc. Bronze is much safer in that respect and bronze tools should be used wherever possible. Beryllium bronze was strongly recommended at one time. However the toxic properties of beryllium limit its application.

The inflammability of gas mixtures were investigated by early workers, such as Davy, Bunsen and particularly the French School of Le Chatelier and M. Berthelot.

TABLE 196
POTENTIAL OF THE ELECTRIC CHARGE
PRODUCED BY MOVING LIQUIDS ALONG
METAL TUBES AT THE RATE OF 3 m/sec
(DOLEZALEK [61])

Liquid	Metal	Potential (V)
Moist ether	Fe	3100
	Al	2500
	Cu	2000
	Brass	1200
	Pb	700
Dry ether	Fe	3100
	Al	2200
	Cu	3000
	Brass	1300
	Pb	2200

Investigation of the limits of flammability and of self-propagation of flame through a gaseous explosive medium became one of the main subjects of research on the combustion of gaseous mixtures.

Early results are collected in the monograph of Bone and Townend [62].

The investigations of White [63] were particularly important. He discovered that the limits of flammability depend not only on the chemical nature of the vapours but also on the direction of propagation of the flame. Figures for combustion in glass tubes 7.5 cm dia. are collected in Table 197.

TABLE 197

Vapour	Limits of propagation of flame in air	
	Upward (%)	Downward (%)
Methyl alcohol	7.05-36.5	7.45-26.5
Ethyl alcohol	3.56-18.0	3.75-11.5
Ethyl ether	1.71-48.0	1.85-6.40
Acetone	2.89-12.95	2.93-8.60
Benzene	1.41-7.45	1.46-5.55

In his later experiments White [64] found that the limits vary with the diameter of the tube, being wider in tubes of larger diameter.

Although considerable research has been carried out after these classic experiments, and a number of excellent monographs has appeared dealing with explosions of gas mixtures [65-68] little has been added to our knowledge of the limits of gas explosions.

Recent data given by Lewis and von Elbe [66] are collected in Table 198.

It is now well established that in large tanks and large compartments the limits of gas explosions are wider than in relatively narrow tubes.

Powder grains

Powder grains are sensitive to impact and friction. This is due to the sensitiveness of the main ingredients, nitrocellulose and nitroglycerine. The sensitiveness of these compounds was discussed in Vol. II.

It should be born in mind that the sensitiveness to impact and friction increases with temperature. Hence any handling of warm powder (e.g. immediately after drying) should be avoided.

Another danger is produced by the ease with which a powder (particularly warm one) can be charged with static electricity. This can be produced by the friction of warm air passing through the layer of powder grains in the course of drying. It can also be produced in the course of mixing and screening, and in the polishing drum.

The last operation should be considered particularly dangerous because of the high potential of the electric charge which can be created under prolonged friction at an elevated temperature. According to the literature [60] celluloid (which possesses properties very similar to nitrocellulose powder) can be charged to 40,000 V by simple friction.

All machinery for powder manufacture should therefore be carefully earthed.

TABLE 198
LIMITS OF VAPOUR-AIR MIXTURE INFLAMMABILITY [66]

Vapour	Limits of inflammability	
	Lower (%)	Upper (%)
Methyl alcohol	6.72	36.50
Ethyl alcohol	3.28	18.95
Amyl alcohol	1.19	—
Isoamyl alcohol	1.20	—
Diethyl ether	1.85	36.50
Acetone	2.55	12.80
Ethyl acetate	2.18	11.40

Buildings and their lay-out

In the manufacture of smokeless powder the primary danger lies not in explosion but in an outbreak of fire. For this reason the buildings usually have walls of a standard thickness, with the exception of those in which a large quantity of powder is accumulated. In drying houses, for instance, a blow-out construction, with one

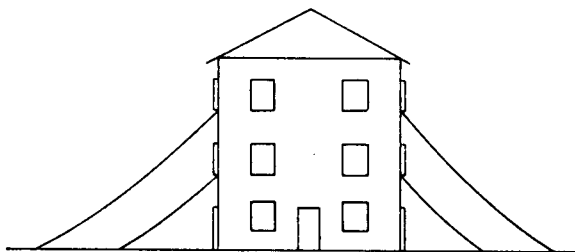

FIG. 276. A rescue ramp in a multistoreyed building.



FIG. 277. General view of a smokeless powder factory (Western Cartridge Company, Division of Olin Industries, Inc., East Alton, Illinois, U.S.A.).

light wall, may be adopted. Buildings in which there is a risk of explosions of a mixture of solvent vapours with air are of similar construction. All buildings are usually one storied, although sometimes there are installations requiring a multi-storied design. These buildings are provided with emergency chutes (Fig. 276) for rapid exit from the upper floors. In some countries to permit the rapid escape of workers in case of fire, the regulations demand that no part of the premises should be further than 4.5 metres from a door. As in all factories or laboratories where explosives are dealt with, the doors open outwards.

Cement basins filled with water are placed by buildings in which particularly dangerous work is carried on. The water is heated in winter. If a workman's clothes should catch fire he can immediately jump into one of the basins. The water should be changed frequently and kept clean to prevent the risk of infection of burns.

Electric installations should be hermetically sealed and non-sparking. The bulbs should be enclosed in safety shields. Electric motors should not be installed in premises in which powder is manufactured.

The distance between the buildings should be large enough to prevent transmission of a fire from one building to another. A typical lay-out of a powder factory is given in Fig. 277.

LITERATURE

1. A. G. GORST, *Porokha i vzryvchatyye veshchestva*, Oborongiz, Moskva, 1957.
2. U. GALLWITZ, *Die Geschützladungen*, Heereswaffenamt, 1944.
3. C. LUNDHOLM and J. SAYERS, Ger. Pat. 53296 (1889).
4. I. N. ZAKHAROV (1892), according to V. A. BOLDYRYEV and S. A. BROUNS, *Kratkii kurs tekhnologii porokha*, p. 108, Gosnatekhizdat, Moskva-Leningrad, 1932.
5. D. I. MENDELEYEV, *Sochineniya* (1890-1894), Vol. IX, Izd. Akad. Nauk SSSR, Leningrad-Moskva, 1949.
6. E. BERL and I. M. DELPY, *Z. ges. Schiess- u. Sprengstoffw.* 8, 129 (1913).
7. H. BRUNSWIG, *Das rauchlose Pulver*, W. de Gruyter & Co., Berlin & Leipzig, 1926.
8. P. PASCAL, *Explosifs, poudres, gaz de combat*, Hermann, Paris, 1924.
9. PONCHON, *Mém. poudres* 19, 81 (1922).
10. L. G. SVETLOV, *Piroksilin i bezdymnyi porokh* (Ed. L. G. SVETLOV and N. S. PUZHAI) 2, 308 (1935) (ONTI, Moskva).
11. T. S. YEGOROV, *Proizvodstvo bezdymnogo piroksilinovogo porokha*, Moskva, 1935.
12. T. L. DAVIS, *The Chemistry of Powder and Explosives*, Wiley, New York, 1943.
13. L. VENNIN, E. BURLLOT and H. LÉCORCHÉ, *Les poudres et explosifs*, Béranger, Paris-Liège, 1932.
14. CLAUDE, according to *Celluloide de Oyonnax*, 1910.
15. J. H. BRÉGEAT, Fr. Pat. 502882, 502957 (1916); 503728 (1917); Technical Records of Explosives Supply 1915-1918, No. 8, *Solvent Recovery*, H.M.S.O., London, 1921.
16. C. SUDLITZ, unpublished results (1932).
17. Poudrerie du Ripault, *Mém. poudres* 21, 178 (1924).
18. R. BRUN and ROTOUIS, *Mém. poudres* 36, 163 (1954).
19. A. V. SUKHINSKII (1892-1894), according to V. A. BOLDYRYEV and S. A. BROUNS, *Kratkii kurs tekhnologii porokha*, Gosnatekhizdat, Moskva-Leningrad, 1932.

20. E. BAZYLEWICZ-KNIAŻYKOWSKI and K. PARTYKA, Ger. Pat. 570459 (1932); Swedish Pat. 73851 (1931).
21. PASSBURG, Ger. Pat. 28971, 40844 (1884); 56330 (1890).
22. BONNEAUD, unpublished report (1918).
23. N. L. HANSEN, *Z. ges. Schiess- u. Sprengstoffw.* **6**, 461 (1911).
24. According to L. VENNIN and G. CHESNEAU, *Les poudres et explosifs et les mesures de sécurité dans les mines de huille*, Béranger, Paris-Liège, 1914.
25. T. L. DAVIS, *Army Ordnance* **2**, 9 (1921); *Ind. Eng. Chem.* **14**, 1140 (1922).
26. J. A. ZAEHRINGER, *Solid propellant rockets*, Amer. Rocket Co. Box 1112, Wyandotte, Michigan, 1955.
27. F. OLSEN, G. C. TIBBITTS and E. B. W. KERONE, U.S. Pat. 2027114 (1936); 2111075 (1938); 2175212 (1939); 2206916 (1940).
28. T. R. OLIVE, *Chem. Engineering* **53**, 136 (1946).
29. Olin Industries Inc., East Alton, Ill., U.S.A.
30. P. BROWN, *The American Rifleman*, p. 17, December, 1952.
31. According to D. R. CAMERON, in *Encyclopedia of Chemical Technology*, Ed. R. E. KIRK and D. F. OTHMER, Vol. 6, Interscience, New York, 1951.
32. R. ROBERTSON and W. RINTOUL, Brit. Pat. 25994 (1901).
33. BIOS/JAP/PR/1292/Report. Japanese Propellants—Research on Non-volatile Solvent Powders, H.M.S.O., London.
34. M. MARQUEYROL and FLORENTIN, *Mém. poudres* **18**, 150 (1921).
35. J. D. HUFFINGTON, *Trans. Faraday Soc.* **47**, 864 (1951).
36. *Engineer (London)* **185**, 286 (1948).
37. W. H. WHEELER, H. WHITTAKER and H. H. M. PIKE, *J. Inst. Fue* **20**, 137 (1947).
38. G. FLEURY, *Mém. poudres* **24**, 49 (1930–1931).
39. H. FREYER and Dynamit Nobel A.G. Troisdorf, Ger. Pat. 1013555 (1957); 1053373 (1959); 1082175 (1960).
40. G. SCHENKEL, *Schneckenpressen für Kunststoffe*, Hanser, München, 1959.
41. K. WRÓBEL and J. ŁUCZAJ, *Wytłaczanie tworzyw sztucznych*, PWT, Warszawa, 1961.
42. CIOS XXVII-72, Manufacture of Solventless Type Smokeless Powder and Nipolit, Deutsche Sprengchemie G.m.b.H.; Technical Report P.B. 925, Explosive Plant D.A.G. Krümmel, Dünneberg, Christianstadt, U.S. Dept. of Commerce, Washington, 1945.
43. H. DAUTRICHE, *Compt. rend.* **146**, 535 (1908); Fr. Pat. 385769 (1907).
44. E. S. GOODYEAR, U.S. Pat. 2228309 (1941).
45. P. VIEILLE, *Mém. poudres* **11**, 157 (1901).
46. V. RECCHI, *Z. ges. Schiess- u. Sprengstoffw.* **1**, 285 (1906).
47. J. N. PRING, *Industr. Chem. Manuf.* **24**, 467 (1948); *Chem. Trade* **122**, 473 (1948).
48. Köln-Rottweil Pulverfabrik, Ger. Pat. 277594 (1913).
49. *Chemical & Engineering News* **41**, No. 8 (February 25) 29 (1963).
50. M. E. SEREBRYAKOV, *Vnutrennaya ballistika*, Oborongiz, Moskva, 1962.
51. W. LEY, *Rockets, Missiles and Space Travel*, The Viking Press, New York, 1954.
52. *20th Meeting Bulletin, Joint-Army-Navy-Air-Force-ARPA-NASA Panel on Physical Properties of Solid Propellants*, 1961, Riverside, California, Vol. I and II, John's Hopkins University, 1963.
53. R. STEINBERGER, Preparation and properties of double base propellants, in *The Chemistry of Propellants*, AGARD Panel, Paris, 1959 (Ed. S. S. PENNER and J. DUCARME), Pergamon Press, Oxford, 1960.
54. D. E. BOYNTON and J. W. SCHOWENGARDT, *Chemical Engineering Progress* **59**, 81 (1963).
55. H. GROSSE in *The Chemistry of Propellants*, AGARD Panel, Paris, 1951 (Ed. S. S. PENNER and J. DUCARME), p. 303, Pergamon Press, Oxford, 1960.
56. G. P. SUTTON, *Rocket Propulsion Elements*, Wiley, New York, 1956.
57. J. TAYLOR, *Solid Propellants and Exothermic Compositions*, Newnes, London, 1959.

58. F. A. WARREN, *Rocket Propellants*, Reinhold, New York, 1958.
59. RICHTER, *Angew. Chem.* **6**, 218, 502 (1893).
60. H. FREYTAG, *Raumexplosionen durch statische Elektrizität*, Verlag Chemie, Berlin, 1938.
61. DOLEZALEK, *Chem. Ind.* **33**, 147 (1913).
62. W. A. BONE and D. T. A. TOWNEND, *Flame and Combustion in Gases*, Longmans, Green & Co., London, 1927.
63. A. G. WHITE, *J. Chem. Soc.* **121**, 1244, 1688, 2561 (1922).
64. A. G. WHITE, *J. Chem. Soc.* **125**, 2387 (1924); **127**, 48, 672 (1925).
65. W. JOST, *Explosions- u. Verbrennungsvorgänge in Gasen*, Berlin, 1939; W. JOST and H. O. CROFT, *Explosion and Combustion Processes in Gases*, McGraw-Hill, New York, 1946.
66. B. LEWIS and G. VON ELBE, *Combustion, Flames and Explosions in Gases*, Academic Press, New York, 1951.
67. V. N. KONDRATYEV, *Kinetika khimicheskikh gazovykh reaktsii*, Izd. Akad. Nauk SSSR, Moskva, 1958.
68. A. S. SOKOLNIK, *Samovosplomenenye, plamya i detonatsia v gazakh*, Izd. Akad. Nauk SSSR, Moskva, 1960.

AUTHOR INDEX

Page numbers in parentheses denote references to Literature lists

- AARONSON, H. A. (243)
ABEL, F. A. 335, 336, 340 (363), 402 (495),
530, 563 (568, 569)
ABERNETHY, C. L. 45, 49 (75)
ABRAMS, A. J. J. 15, 29 (38)
ADAMS, R. (200)
ADICOFF, A. (394)
ADRYANOV, N. F. (526)
AHRENS, H. 421 (496, 497)
AKRE, R. L. 482 (497)
ALBERTUS MAGNUS 323
ALEKSEYEV, D. 168 (198)
ALLEN, C. F. H. 51 (75)
VAN ALPHEN, J. 19 (38)
ALTERMAN, Z. 380 (394)
ALTMAN, D. 295 (320)
ALVISI, U. 280 (287)
AMBLE, E. 162 (197)
AMOS, A. A. (39)
AMSTER, A. B. (394)
ANDERSEN, W. H. 381, 391 (393)
ANDERSON, J. D. C. 201 (241)
ANDREWS, D. H. 256 (286)
ANDREYEV, K. K. 55 (75), 86 (125), 171 (198),
342 (364)
ANDREYEVSKII 130
ANDRUSSOW, L. (285), 290 (319)
ANGELI, A. 222 (242), 555, 556 (569)
ANGELICO, F. 136 (159)
APIN, A. YA. 85 (125)
ARISTOFF, E. (126)
ASHDOWN 562, 563 (569)
ASKEY, P. J. 305 (320)
ASSONOV, V. A. 424, 425 (496)
ATKINSON, A. 121 (126)
ATZWANGER, H. 313 (321)
AUBERTEIN, P. 33 (39), 84, 121, 122 (125,
126), 268 (287)
AUDIBERT, E. 184 (199), 398, 409, 411 (495, 496)
AUDRIETH, L. F. 169 (198), 307 (320)
AUNIS, G. 30 (39)
AVOGADRO, M. 83, 84 (125)
AVRAMENKO, L. J. 547 (568)
AZÁROFF, L. V. 169 (198)
BACCHUS (363)
BACHMANN, W. E. 18 (38), 112, 114, 118,
121 (126)
BACKER, H. J. 2, 4 (14, 75)
BACON, ROGER 323
BADOCHÉ, M. 122 (127)
BADOWSKI 493
BAEYER, A. 225 (242)
BAILEY, B. M. 316 (321)
BAIN, C. J. 58 (76)
BAKER, B. E. (320)
BAKER, L. L. 295 (319)
BALDWIN, R. R. 303 (320)
BALY, E. C. C. 2 (13), 24 (39)
BAMBERGER, E. 5, 7, 10, 13 (14), 201 (240)
BAMFORD, C. H. 305 (320)
BARAB, J. 6 (14)
BARANGER, P. 226 (242)
BARCIKOWSKI, J. 217 (242)
BARON, L. I. (526)
BARRÈRE, M. 294 (319)
BARROT, J. 6 (14)
BARTLETT, B. E. 143 (159), 184 (199)
BARTON, S. S. 26, 27 (39)
BAUER, W. 296 (320)
BAZYLEWICZ-KNIAŻYKOWSKI, E. 617 (687)
BECK, W. 133 (158)
BECKER, E. D. 167 (198)
BECKER, F. 35 (39), 83 (125)
BECKMAN, A. O. 167 (197, 198), 305 (320)
BEDARD, M. (126)
BEDNARCZYK, M. (241)

- BEHRENS, H. 298, 299 (320)
 BELAYEV, A. F. 49 (75), 139, 147 (159), 204 (241), 537 (568)
 BELAYEVA, A. E. 147 (159), 204 (241)
 BELL, R. P. 15, 16 (38)
 BELLAMY, L. J. 3, 4 (14), 25 (39), 165 (197)
 BELLINGER, F. 296 (320)
 BELLOT 129
 BENNETT, G. M. 70 (76)
 BENTON, A. F. 224 (242)
 BERCHTOLD, J. 146 (159), 171, 182 (198)
 BERG, A. 11 (14)
 BERGER, E. 560 (569)
 BERGMANN, E. 558 (569)
 BERL, E. 573 (686)
 BERMAN, L. 92 (126)
 BERNARD, M. L. J. 295 (320)
 BERNARDINI 254 (286)
 BERTHELOT, D. 557 (569)
 BERTHELOT, M. 138, 148 (159), 190 (199, 200), 201, 224, 227, 228, 229 (240, 242, 243), 326, 336 (363), 397, 683
 BERTHMANN, A. 137 (159)
 BERTHOLLET, C. 274 (287), 334 (363)
 BEYERSDORFER, P. 420 (496)
 BEYLING 409, 410, 412 (496)
 BHADURI, K. 228 (243)
 BICHEL, C. E. 281 (287), 398, 400 (495)
 BICKFORD 130 (131)
 BILLS, K. W. 381, 391 (393)
 BINNIE, W. P. 108 (126)
 BIQUARD, P. 543 (568)
 BLACKWOOD, J. D. 326, 338, 339, 341 (363)
 BLANCHARD, K. C. 15, 33, 34 (38)
 BLANKSMA, J. J. 63, 65, 66 (76)
 BLINOV, I. F. 276 (287)
 BLOCHMANN, R. 228 (243)
 BLOKHSHEIN, F. I. 193 (200)
 BOBOVICH, YA. 3 (14)
 BOGDAL, S. 46 (75)
 BOGOYAVLENSKII, A. (75)
 BOGUSH, O. F. 256 (286)
 BOILEAU, J. (287)
 BOLDYRYEV, V. A. (686)
 BOMBRIINI-PARODI, DELFINO 258 (286)
 BONE, W. A. 683 (688)
 BONHOEFFER, K. F. 547 (568)
 BONNEAUD 621 (687)
 BOUCARD, J. 432 (497)
 BOUDET, J. 138 (159)
 BOURJOL, G. 31, 32 (39)
 BOWDEN, F. P. 144 (159), 172, 183, 184 (198, 199), 211 (241, 242), 326, 338, 339, 341 (363)
 BOWDEN, R. C. (126)
 BOWERSOCK, D. C. 316 (321)
 BOYD, N. C. 254 (285)
 BOYER, J. H. 164, 194, 196 (197, 200)
 BOYNTON, D. E. 675, 681 (687)
 BRADT, P. 167 (198)
 BRATTAN 303 (320)
 BRAUDE, E. A. 163 (197)
 BRAUN, E. 163 (197)
 BRÉGEAT, J. H. 603, 604 (686)
 BREYRE, A. (495)
 BRIAN, R. C. 11 (14), 17 (38)
 BRINKLEY, S. R. (497)
 BROCHET, A. 121 (127)
 BROCKMANN, F. J. 81, 122 (125)
 BROUNS, S. A. (686)
 BROWN, F. W. 176 (199), 314 (321), 543 (568)
 BROWN, H. R. 217 (242)
 BROWN, P. 635, 636 (687)
 BRUGÈRE 335 (363)
 DE BRUIN, G. 554, 556 (569)
 BRUN, R. 616 (686)
 BRUNET, P. E. 25 (39)
 BRUNSWIG, H. 532, 533, 535 (536, 539, 551, 552, 553, 554, 563, 566 (568), 574 (686)
 BRUSON, H. A. 73 (76)
 BRYAN, G. J. 172 (199), 216 (242, 394)
 BUDNIKOV, M. A. 150, 152, 153 (160)
 BUISSON, A. 551 (569)
 BULL, W. 296 (320)
 BUNSEN, R. 336 (363)
 BURIKS, R. S. (200)
 BURLET, G. 44, 45 (75)
 BURLLOT, E. 154 (160), 236, 237 (243, 527), 541 (568, 686)
 BURTON, O. E. 208 (241)
 BUSHNELL, V. C. (320)
 BYSTROV, I. V. (160)
 CALDIN, E. F. 16 (38)
 CALUS, H. 552, 556 (569)
 CAMBIER, R. 121 (127)
 CAMERON, D. R. (568, 687)
 CAMPBELL, C. 280 (287), 382 (394)
 CANRIGHT, R. B. 293 (319)
 CANTER, F. C. 196 (200)
 CARLETON, L. T. 365, 366 (393)
 CARLSON, O. F. 280 (287), 473

- CARLTON SUTTON, T. 54 (75)
 CARMACK, M. 2 (14), 223 (242)
 CARRUCCINI, R. J. (320)
 CARRUTHERS, A. 88 (125)
 CARSTANJEN, E. 140 (159)
 CASON, J. 120 (126), 223 (242)
 CATELAIN, E. 228 (243)
 CAVE, G. A. 32 (39)
 CHAIKEN, R. F. 391 (393)
 CHALON, P. F. (363)
 CHANDELON 150 (160)
 CHAO, T. S. (197)
 CHAPMAN, F. 116 (126)
 CHAPMAN, J. C. 374 (394)
 LE CHATELIER, H. 396, 397 (495), 683
 CHAYLAN, E. 268 (287)
 CHELTSOV, I. M. 258 (286)
 CHESNEAU, G. (687)
 CHETYRKIN, W. N. 93 (126)
 CHEVALIER 149 (160)
 CHEVREUIL, M. 336 (363)
 CHICHIBABIN, A. E. 8 (14)
 CHRETIEN, A. 211 (241)
 CHUTE, W. J. (14), 36 (39), 92 (126)
 CIRULIS, A. 185 (199)
 CLAESSEN, C. 530 (568)
 CLARK, L. V. 70, 71, 72 (76), 202, 203, 204 (241)
 CLARKSON, C. E. 41, 42 (74)
 CLAUDE 603 (686)
 CLIFT, G. D. (243)
 CLUSIUS, H. 168 (198)
 CLUSIUS, K. 15 (38), 162 (197)
 COHEN, H. L. 108 (126)
 COHEN, J. (39)
 COLLI, A. J. 389
 COOK, M. A. 31 (39), 54 (75), 85 (125), 290 (319)
 COOPER, P. D. (39)
 COPE, W. C. 6 (14), 55 (76), 233
 COPP, J. L. 261 (286)
 COREY, B. B. 2 (14)
 COSTAIN, W. 2 (13)
 COURTNEY-PRATT, J. S. 182, 183 (199)
 COWARD, H. F. 545 (568)
 COX, E. G. 2 (13)
 COX, R. F. B. 70 (76)
 DE CRATER, W. C. 48 (75, 125)
 CRAWFORD 522
 CRIEGEE, R. (243)
 CROFT, H. O. (688)
 CUNNINGHAM, G. L. 224 (242)
 CURTIUS, T. 161, 166, 168, 185, 190, 191,
 192 (196, 197, 200)
 CYBULSKI, W. 407, 410, 411, 413, 417, 418,
 419, 420, 461, 477 (496, 497)
 VON DAHMEN 266 (286)
 DAILEY, B. P. 162 (197)
 DAMON, G. H. (497)
 DARAPSKY, A. 166 (197)
 DAUTRICHE, H. (287), 398 (495), 541, 546
 (569), 663 (687)
 DAVIDSON, S. H. 490 (497)
 DAVIDSON, W. B. 201 (240)
 DAVIES, A. G. 227 (243)
 DAVIES, D. A. 324 (363)
 DAVIS, N. S., Jr. 300 (320)
 DAVIS, T. L. 15, 24, 28, 29, 33, 34 (38, 39),
 48, 49, 51, 67 (75, 76), 152 (160), 174
 (199), 210, 236, 238 (241, 243), 562, 563
 (569), 590, 597, 622, 624, 646 (686, 687)
 DAVY, HUMPHREY 396
 DEB, S. K. 164, 165, 187, 188, 196 (197, 199)
 DEBENEDETTI, B. 559 (569)
 DEBUS, H. 337 (363)
 DEFFET, L. 431, 432 (497)
 DEISSLER 266 (286)
 DEKKER, A. O. 2 (14), 387, 388 (394)
 DELAY, A. 165 (197)
 DELÉPINE, M. 81, 122 (125, 127)
 DELPY, I. M. 573 (686)
 DEMELENNE, E. 489 (497)
 DEMIDYUK, G. P. (526)
 DEMOUGIN, P. 560 (569)
 DENNIS, L. M. 166, 185 (197)
 DENO, N. C. 121 (126)
 DESCARTES, RENÉ 335 (363)
 DESCH, C. M. 2 (13), 24 (39)
 DESIGNOLLE 334 (363)
 DESMAROUX, J. 561 (569)
 DESSEIGNE, G. 61 (76), 256 (286)
 DESVERGNES, L. 23 (39), 46, 51, 53 (75)
 DEWAR 530 (568)
 DIBELER, V. H. 167 (198)
 DICKEY, J. B. (14)
 DICKINSON, R. G. 167 (197, 198)
 DICKSON, G. 326 (363)
 DIETL 141 (159)
 DIETZ, W. (321)
 DIMROTH, O. (200), 326 (363)
 DITTMAR, P. 35 (39), 83 (125, 287)
 DIXON, W. J. 445 (497)
 DOBRZYŃSKI 217 (242)
 VAN DOLAH, R. W. 446 (497), 508 (526)

- DOLE, S. H. 319 (321)
DOLEZALEK 682 (688)
DOLEŽEL, Z. 122 (127)
DOLLFUS, F. E. (14)
DOMAŃSKI, T. 37 (39)
DOUGHERTY, C. F. 389 (394)
DOWNING, D. C. 81, 123 (125, 126)
DOWS, D. A. 164, 167 (197, 198)
VAN DREBBEL 129
DUBNOV, L. V. 413, 420, 427, 428, 429
(496)
DUBSKY, J. V. 9 (14)
DUCARME, J. (321, 687)
DUDEN, P. 121 (126)
VAN DUIN, C. F. 53, 64, 65 (75, 76)
DUNN, G. E. (14)
DUNNING, K. W. 92 (126)
DUNNING, W. J. 92, 94, 96 (125, 126)
DUTOUR, M. 122, 123, 124 (127)
VON DUTTENHOFER, M. 529 (568)
DUVAL, C. 165 (197)
DWYER, J. 547 (568)
DYKSTRA, P. R. 372, 376, 377, 378 (394)
- EASTERFIELD, T. H. 326 (363)
EASTES, J. 296 (320)
EBELE 109
EDWARDS, G. 78 (125)
EFFENBERGER, E. (198)
EGG 129
EGGERT, J. 145 (159), 171, 182, 183 (198)
EHRENBERG, A. 140 (159)
EJSMUND, J. (241)
VON ELBE, H. 538 (568), 684 (688)
ELDERFIELD, R. C. 28 (39)
ELDRED, D. N. 134 (158)
ELGIN, J. C. 305 (320)
ELLIOT, M. A. 314 (321)
ENGELBRECHT, A. 313 (321)
EPHRAIM, F. 230 (243)
EPSTEIN, S. 82, 118, 119 (125, 126)
VAN ERP, H. 4, 6 (14)
ESCALES, R. 266 (286), 352 (363, 364)
ESPENSCHIED, R. 229 (243)
EULER, H. 4 (14)
EVANS, B. L. 163, 164, 169, 183, 186, 191
(197, 198, 199)
EVANS, J. I. 145 (159), 172 (199), 216
(242)
EVANS, W. M. 261 (286)
EYSTER, E. H. 162, 164 (197)
- FARMER, R. C. 51, 52, 53 (75), 139, 142, 146 (159)
FARREL 522
FAVEAU, J. 546 (568)
FEDOROFF, B. T. 231 (243, 287)
FEDOSYEV, W. I. 294, 298, 308, 309, 311 (319)
FEITKNECHT, W. 178 (199)
FELDHAUS (131)
LE FÈVRE, R. J. W. 201 (241)
FICHEROULLE, H. 121 (126), 189, 190 (199)
FIERZ, H. E. (200)
FIEDOROV, N. P. 336 (363)
FISCHER, C. N. (76)
FLEMING, J. S. B. 432 (497)
FLEURY, G. 655, 656 (687)
FLORENTIN 645 (687)
FLYGARE, H. 231 (243)
FONER, S. N. 168 (198)
FONG, L. L. (569)
FÖRG, R. 269 (287)
FORST, W. 303 (320)
FORSTER, A. (126)
FÖRSTER, F. 529 (567)
FORSTER, M. O. 191 (200)
FORSYTH 129
FRANCE, A. D. G. (200)
FRANCHIMONT, A. P. N. 2, 5, 6, 7, 9, 10 (14),
18, 25, 34, 36 (38, 39, 75)
FRANKLIN, E. C. 161 (197)
FRANKLIN, J. L. 167 (198)
FRANZEN, H. 230 (243)
FREAMO, M. 167 (198)
FREIWALD, H. 253 (285)
FREVEL, L. K. 161 (197)
FREYER, H. (687)
FREYTAG, H. 131 (131), 682 (688)
FRIEDMAN, H. 296 (320)
FRIEDRICH, W. 230, 231 (243)
FRIESE, P. 224 (242)
FRIPIAT, J. 407 (495)
- GAENS 331 (363)
GALAS, T. 85 (125), 540 (568)
GALINOWSKI, S. 68 (76)
GALLOWAY, R. L. 401 (495)
GALLWITZ, H. 531, 540 (568), 572 (686)
GANAPATHI, K. 8 (14)
GANTZ, E. S. C. 26 (39)
GARFIELD, F. M. 202 (241)
GARNER, W. E. 45, 49 (75), 142, 143 (159),
165, 169, 171, 172, 177, 182, 186, 187
(197, 198, 199), 215 (242)

- GAY, P. F. 396, 397, 401, 414, 415, 416, 419,
422, 433, 463, 464, 465, 466, 467, 468,
490 (495), 522, 524 (527)
- GAY, W. A. 290 (319)
- GAYDON, A. G. 167 (198)
- GAY-LUSSAC, J. 335 (363)
- GAUDECHON 557 (569)
- GIBSON, F. C. 176 (199), 543 (568)
- GIBSON, J. W. 446 (497)
- GIGUÈRE, P. A. 303 (320)
- GILBERT, E. C. 305 (320)
- GILLETTE, R. H. 164 (197)
- GILLIBRAND, M. I. 4, 6 (14)
- GILLIES, A. 116 (126)
- GILMAN, H. (39)
- GILPIN, V. 95, 112 (126)
- GIRARD, C. 253 (285)
- GIRSEWALD, C. 225, 226 (242)
- GIUA, M. 52 (75), 256 (286)
- GLASSMAN, J. 310 (320)
- GLEN, K. 168 (198)
- GŁOWIAK, B. 195 (200), 202, 205, 206
(241)
- GNEHM, R. 73, 74 (76)
- GÖBEL, G. 369 (394)
- GOLDSCHMIDT 266 (286)
- GOMBERG, M. 222 (242)
- GOMM, A. S. 165, 169, 172, 186 (197), 215
(242)
- GOODYEAR, E. S. 664 (687)
- GORDON, A. S. 307 (320)
- GORDON, S. 280 (287), 382 (394)
- GORDON, W. E. (497)
- GORST, A. G. (131), 146 (159), 234 (243, 285,
286), 324 (363), 559, 571 (596, 686)
- GOWAN, J. E. (200)
- GRAHAM, J. A. (126)
- GRANT, R. L. 212, 233 (241), 446 (497)
- GRAY, P. 164, 165, 167, 169, 170, 183, 186,
187, 188, 191, 196 (197, 198, 199)
- GREEK, B. F. 389 (394)
- GREENSPAN, F. P. 300, 302, 304, 305
(320)
- GREENSPAN, J. 15 (38)
- GRIESS, P. 121 (126), 202, 214 (241)
- GRIFFITH, R. L. 224 (242)
- GRIGOROVICH, P. 139 (159)
- GRIMSHAW, H. C. 420, 446 (496, 497)
- GRODZINSKI, J. 280 (287), 381, 382 (394)
- GROLLIER-BARON, R. 293, 294 (319)
- GROOOCK, J. M. 171 (198)
- GROSSE, H. 681 (687)
- GROTTANELLI (126)
- GRUNDMAN, C. 190 (200)
- GÜNTHER, P. 289 (319)
- GÜNTHER, P. L. 171, 190 (198, 199)
- GUTTMANN, O. (364, 527)
- HACKEL, J. 265, 260, 262 (263, 286)
- HACKSPILL, L. 421 (496)
- HAGUI, J. 256 (286)
- HAD, A. 35 (39), 53 (75), 83 (125), 147 (160),
172, 195 (199), 492, 494 (497)
- HAILES, H. R. 142 (159), 215, 216 (242)
- HAÏSSINSKY, M. 171 (198)
- HALE, G. C. 19, 20 (38), 77, 87 (125)
- HALL, R. H. 26, 27 (39), 217 (242)
- HANCOCK, J. C. 416, 490 (496, 497)
- HANNA, N. E. (497)
- HANNUM, J. A. 299 (320)
- HANSEN, N. L. 622 (687)
- HANTKE 278 (287)
- HANTZSCH, A. 4, 6 (14), 34 (38, 39), 201, 222
(240, 242)
- HARRIS, S. R. 21 (38), 212 (241)
- HARRISON, P. L. 173 (199)
- HARROW, G. 121 (126)
- HARTIG 529 (567)
- HARTMANN, I. 217 (242)
- HARTWELL, F. J. 545 (568)
- HASLAM, R. 490 (497)
- HATTON, W. G. 212 (241)
- HAWKES, A. S. 173 (199)
- HAYCOCK, E. W. 142 (159), 184 (199)
- HEIDENREICH, K. 192 (200)
- HEIN, F. 232 (243)
- HELLHOFF 290 (319)
- HELMHOLZ 522
- HENDRICKS, L. B. 161 (197)
- HENNING, G. F. 77 (125)
- HENRI, V. 163 (197)
- HENRY, R. A. (39)
- HERRING, K. G. (14), 36 (39)
- HERRON, J. T. 167 (198)
- HERSH, C. K. 309 (320)
- HERZ, E. 37, 38 (39), 70 (76), 201, 214 (240,
241)
- HERZ, G. C. V. 77, 80 (125)
- HERZBERG, G. 162 (197)
- HESS 141 (159)
- HILGERT, H. 305 (320)
- HINO, K. 423, 435, 436 (496, 497)
- HINSHELWOOD, C. N. 53 (75), 224 (242)

- HIRST, E. L. 17 (38), 88, 91 (125)
 HISCOCK 409 (496)
 HOARE, D. E. 303 (320)
 HOARE, F. R. I. 231 (243)
 HOCK, H. (241)
 HODGKINSON, W. R. 231 (243)
 HODGSON, H. H. 42 (74), 201 (241)
 HOERGER, E. (569)
 HOFFMAN, C. W. W. (197)
 HOFFMANN, K. A. 206, 207 (241), 337 (364)
 HOFMAN, W. 327 (363)
 HOFMANN, A. W. 19 (38)
 HOLDEN, I. G. 41, 42 (74)
 HOLLEMAN, A. F. 138 (159)
 HOLZNAGEL, W. 191 (200)
 HORTON, W. J. (38, 126)
 HORWITZ, J. P. 207 (241)
 HOWARD 129 (131)
 HRYNAKOWSKI, K. 256 (286)
 HUBER, H. (126)
 HUDSON, R. L. 168 (198)
 HUFFINGTON, J. D. 538 (568), 647 (687)
 HUGGETT, C. 375 (394)
 HUGHES, A. M. 305 (320)
 HUGHES, E. D. 5 (14)
 VAN HÜLLEN 581
 HULTGREN 78 (125)
- ILOSVAY, L. 228 (243)
 INGOLD, C. K. 5 (14)
 ISHAM, H. 166, 185 (197)
 ISSOIRE, J. 44, 45 (75)
 IZZO, A. 86 (125)
- JACOBS, P. W. M. 163, 183, 187, 188, 189
 (197, 199)
 JACQUET, P. A. 314, 315 (321)
 JAFFE, I. 393 (394)
 JAHN, A. 169 (198)
 JAHNSEN, A. 230 (243)
 JANNASCH, P. 169 (198)
 JARRY, R. L. 313 (321)
 JEFFREYS, R. A. (200)
 JENKINS, H. P. 295 (319)
 JENNER, E. L. (38, 126)
 JOLLES, Z. E. 555, 558, 559 (569)
 JONES 306, 307 (320)
 JONES, E. 54 (75)
 JONES, J. K. N. (125)
 JONES, R. N. 2, 3 (13), 24 (39), 222 (242)
- JONES, W. 136 (159)
 JONES, W. H. 82 (125)
 JOST, W. (688)
 JOUSSELIN, L. 22, 25 (38)
 JOVINET, P. L. 256 (286), 564 (569)
 JOYNER, A. R. (197)
 JUETTNER, B. 326 (363)
 JUNK, A. 558 (569)
- KAHANE, E. (321)
 KAHOVEC, L. 164 (197)
 KALINOWSKI, P. 74 (76)
 KAPUŚCIŃSKI, Z. 25, 30, 31, 34 (39), 256 (286)
 KARNOJITZKI, V. (243)
 KAROLYI, M. 336 (363)
 KARPUKHIN, P. P. 93 (126)
 KAST, H. 49, 53, 54 (75), 85 (125, 131), 136,
 137, 138, 147, 148, 151, 152 (159, 160),
 172, 195 (199, 241), 248, 264, 266, 267,
 277, 282 (285, 286), 289 (319), 340
 (364), 456, 492, 494 (497), 540 (568)
 KATCHALSKY, A. 380 (394)
 KAUFMAN, J. V. R. 146 (159), 171, 176 (198),
 203, 217 (241)
 KEDESZY, E. (495)
 KEEFE, J. H., Jr. 300 (320)
 KEISER, E. H. 228 (243)
 KENNEY, J. F. (241)
 KERKOVIVS, B. 326 (363)
 KERONE, E. B. W. (687)
 KHAIBASHEV, O. K. 52 (75), 256 (286)
 KIELCZEWSKI 217 (242)
 KILPATRICK, M. 295 (319)
 KIRCHHOFF, C. 224 (242)
 KIRK, R. E. (241)
 KIRKWOOD, M. W. 26 (39)
 KIRMREUTHER, H. (241)
 KIRPAL, A. 10 (14)
 KIRSCH, M. 97 (126)
 KIRST, W. 484 (497)
 KLEIN, R. 538 (568)
 KLEMENC, A. 201 (241)
 KLOBBIE, E. A. 18 (38)
 KNAGGS, I. E. 162 (197)
 KNIGHT, H. C. 535 (568)
 KNOFF, H. (198)
 KOCH, A. W. 253 (285)
 KOCHMYERZHEVSKII, W. 323 (363)
 KOEHLER, A. 54 (75)
 KÖENEN, H. (287)
 KÖFFLER 105, 111

- KOHLRAUSCH, K. W. F. 164, 165 (197)
KOŁODZIEJCZYK, S. 257 (286)
KOMAR 526
KONDRATYEV, V. N. 547 (568, 688)
KORCZYŃSKI, A. 192 (200)
KOTOWSKI, A. 228 (243)
KOVACHE, A. 121 (126), 189, 190 (199)
KOWALCZYK, M. 224 (242)
KRAUSE, E. 276 (287)
KRAWCZYK, W. 83 (125)
KREMANN, R. 256 (286)
KREYENBUHL, A. 421 (496)
KRIEGER, A. (14)
KROTINGER, N. J. 32 (39)
KRUPKO, W. 170, 171, 173, 176, 185 (198)
KRUSKA, E. 310 (320)
KRUSZYŃSKA, K. 213, 215, 216, 220 (241)
KUHN, W. 163 (197)
KUMLER, W. D. 4, 26 (39)
KUNKEL 129 (131)
KURITA, M. 256 (286)
KUSLER, D. J. 176 (199), 543 (568)
KÜSPERT, F. 228 (243)
KUSTRIA, B. D. 193 (200)
KWIATKOWSKI, B. 79 (125), 251, 256 (285),
566 (569)
- LACHMAN, A. 15, 34 (38, 39)
LAFFITTE, P. 85 (125), 145 (159), 251, 259, 260
(285)
LAMBERTON, A. H. 4, 6, 7, 11, 12 (14), 17
(38), 88, 114 (125, 126)
LANDEL, R. T. 368 (394)
LANDERL, J. D. (569)
LANDON, M. 560 (569)
LANDSTEINER, K. 5 (14)
LANG, F. M. 44, 51 (75, 287)
LANGEVIN, A. 543 (568)
LANGHANS, A. 140, 141, 144 (159), 331 (363)
LANGSETH, A. 162 (197)
LATHAM, A. 316 (321)
LAUFFENBURGIER 421 (496)
LEAVITT, J. J. 2 (14), 223 (242)
LEBEDEV, YU. A. 85 (125)
LEBRUN, F. (496)
LECOMTE, J. 165 (197)
LÉCORCHÉ, H. 154 (160), 236, 237 (243, 257),
564 (569, 686)
LEE, H. B. 482 (497)
LEFEVRE, R. 226 (242)
LEGLER, L. 225 (242)
- LEHMAN, H. A. 191 (200)
LEHMSTEDT, K. (14)
LEITMAN, YA. I. 248 (285)
LEMAIRE, E. 398, 407, 429 (495, 496)
LENK VON WOLFSBURG 528 (567)
VAN LENNEP, B. C. R. 64, 65 (76)
LENZE, F. 53 (75), 77 (125), 130, 202 (241)
LEPIN, L. K. 171 (198)
LEULIER, A. 226 (242)
LEVERING, D. R. 3 (14, 197)
LEVKOVICH, N. A. (160)
LEVY, R. 291 (319)
LEWIS, B. 295, 306, 307 (320, 394), 538 (568),
684 (688)
LEY, W. 302 (320), 674 (687)
LIEBER, E. 3, 4 (14), 164 (197), 207 (241)
LIEBER, F. 28 (39)
LIEBIG, J. 135 (158)
LILLY, C. H. 334 (363)
LINCK, J. 336 (363)
LINDE, C. 288 (319), 491 (497)
LINDLEY, C. (14, 38, 126)
LINHARD, M. 231 (243)
LINSTAD, R. P. 12 (14), 88
LIU, I. D. 303 (320)
LLEWELLYN, F. J. 2 (13), 162 (197)
LMOŃOSOV, M. V. 335
LORLETTE, P. 22, 33 (38), 561, 562 (569)
LOUGHRAN, E. D. (286)
LUKIN, A. YA. 53 (75)
LUNDHOLM, C. 573 (686)
- ŁASZCZYŃSKI 278 (287), 475
ŁUCZAJ, J. (687)
- MACAR 264 (286)
MACDONALD, J. Y. 224 (242)
MACKENZIE, J. C. (14)
MACMULLEN, C. W. 73 (76)
MACNAB, W. 407, 489 (496)
MACNAUGHTON, N. W. (38, 126)
MADOR, J. L. 167 (198)
MAGGS, J. 171, 182, 187 (198, 199)
MAI, J. 192 (200)
MAJRICH, A. 79, 83 (125), 139 (159), 170 (198)
MAKOSKY, R. C. 33 (39)
MAKÓWKA, O. 228 (243)
MALENDOWICZ, W. 84 (125)
MALESKY, J. S. 508 (526)
MALKIN, T. 41, 42 (74)
MALLARD 396 (495)

- MALMBERG, E. W. 2 (14, 569)
 MANUELI, C. 254 (286)
 MARCHENKO, L. N. (526)
 MARCUS GRAECUS 322
 MARCUS, R. A. 116 (126)
 MARGOLIS, M. A. 319 (321)
 MARKE, D. J. B. 187 (199), 334 (363)
 MARLIES, C. A. 15 (38)
 MARQUEYROL, M. 22, 33 (38), 561, 562, 564
 (569), 645 (687)
 MARSCH, H. E., JR. (394)
 MARSDEN, E. 201 (241)
 MARSHALL, A. 138 (159)
 MARSHALL, J. 54 (75)
 MARTIN, F. 55 (76), 158 (160), 185, 186 (199)
 MASON, L. M. (497)
 MASSEY, F. J. (497)
 MATTER, O. 201 (240)
 MATYUSHKO, N. 49 (75), 139 (159)
 MAXIM, H. 248 (285)
 MAXWELL, C. E. (38, 126)
 MAXWELL, W. R. (395)
 MAYER, F. 121 (126)
 MAYER, O. V. 230 (243)
 MAYES, H. A. 227 (243)
 MAYOR, L. 302 (320)
 MAZUR, J. 221 (242)
 MCAUSLAN, J. H. 172, 183 (198, 199), 217
 (242)
 MCCAULEY, J. D. 32 (39)
 MCCOY 484 (497)
 MCCRONE, W. C. 117 (126)
 MCCULLOGH, F., JR. 295 (319)
 MCKAY, A. F. 24, 27, 28 (39), 92 (126), 211,
 212 (241)
 MCKENZIE, R. G. (320)
 MCLAREN, A. C. 164, 170 (197, 198)
 MCLARREN 308 (320)
 MÉDARD, L. 67, 70, 71 (76), 84, 122, 123, 124
 (125, 127), 255, 256 (286), 290, 314 (319,
 321), 505 (526), 541 (568)
 MEEN, R. H. 20 (38), 92 (126)
 MEERKAMPER, B. 171, 182 (198)
 MEISSNER, J. 179, 180, 181 (199), 219, 220 (242)
 MENDELEYEV, D. I. 166 (197), 530 (568, 686)
 MENSTER, M. 538 (568)
 LA MER, V. K. 15 (38)
 MERCHANT, M. E. 314 (321)
 MERTENS, K. H. 40, 42 (74)
 MESROBIAN, R. B. (243)
 METCALF, W. V. 6 (14)
 METTENGANG 398 (496)
 METZ, L. 227 (243)
 MEYER, H. 326 (363)
 MEYER, K. F. 36 (39)
 MEYER, R. 166 (197)
 MEYERS, J. L. (126)
 MICHLER, W. 40, 47 (74, 75)
 MIESZKIS, K. 37 (39)
 MILES, F. D. 136, 138, 139 (159), 169, 173,
 186 (198)
 MILLARD, B. 94, 96 (126)
 MILLON 331 (363)
 MIŁADOWSKI, W. 251 (285), 566 (569)
 MISHUCK, E. 365, 366, 381, 391 (395)
 MITCHELL, D. 54 (75)
 MOE, G. 381, 391 (393)
 MOHLER, H. 163 (197)
 MONNI 549
 MONTAGU-POLLOCK, H. M. 211 (241)
 MOOD, A. M. 445 (497)
 MORAN, E. C. 70 (76)
 MORAY, R. 324 (363)
 MORGAN, J. D. 228 (243)
 MORRIS, F. 543 (568)
 MORRIS, G. 217 (242)
 MOUTET, A. 294 (319)
 MURAOUR, H. 30 (39), 195 (200, 286), 561 (569)
 MURATA, T. 415, 422, 425, 428, 429 (496)
 MUNDY, W. J. 389 (394)
 MUNROE, C. E. (243)
 MURBACH, W. J. (394)
 MURDOCK, H. D. (76)
 MYERS, G. S. 11 (14), 88, 92, 120 (126)
 NAGY, J. 217 (242)
 NAMYSŁOWSKI, S. (200)
 NAOÚM, PH. 36 (39), 282 (287)
 NAPOLY, C. 392 (394)
 NASH, H. 542 (568)
 NAUKHOFF, S. 281 (287)
 NEF, J. U. 135, 136 (158)
 NEWMAN, S. H. (200)
 NEWTON, I. 335
 NICOLARDOT, P. 138 (159)
 NIELSEN, I. R. 162 (197)
 NIKOLSKII 559
 NISHIZAWA, E. (39)
 NISSER 280 (287)
 NOBEL, A. 130 (131), 280 (287), 395 (495), 530,
 559 (568, 569)
 NOBLE, ANDREW 331, 336, 337, 340 (363, 364),
 535 (568)

- NOONAN, E. C. 172 (199), 217 (242, 394)
 NORRBIN, J. H. 259 (286), 395 (495)
 NORRISH, R. G. W. 167 (198), 547 (568, 569)
 NUSSBAUMER 576
 NUTT, C. W. 94, 96 (126)
- OGG, B. S. 307 (320)
 OHLSSON, C. J. 259 (286), 395 (495)
 OHSE, E. 194 (200)
 OLDENBERG, O. 547 (568)
 OLIN, J. M. 169 (198)
 OLIVE, T. R. 632, 637 (687)
 OLSEN, F. 632, 633 (687)
 OLSZEWSKI, K. 288 (319)
 ORTH, H. 154, 499, 500, 502, 503
 ORTIGUES, M. 84 (125)
 ORTON, K. J. P. 8 (14), 43, 44 (75)
 OSTROWSKI, R. 327 (363)
 OTHMER, D. F. (241)
 OTT, E. 194 (200)
 OWSTON, P. G. (14, 126)
 OZA, T. 338 (364)
- PACK, D. A. 290 (319)
 LE PAIRE 546 (568)
 PANNETIER, G. 167 (198)
 PAPROTSKII (363)
 PARISOT, A. 85 (125), 251, 259, 260 (285, 286)
 PARRY, E. 139 (159), 171 (198)
 PARTINGTON, J. R. 323 (363)
 PARTYKA, K. 618 (687)
 PASCAL, P. 256 (286), 289 (319), 352 (364, 686)
 PASSBURG 618 (687)
 PATART, G. 30 (39)
 PATAT, F. (197)
 PATINKIN, S. H. (39), 207 (241)
 PATRY, M. 138, 146, 147, 148 (159)
 PATTERSON, L. J. 3 (14, 197)
 PATTISON, S. 47 (75)
 PAULING, L. 161 (197)
 PAUSHKIN, YA. M. 301, 304, 305 (320)
 DE PAUW, P. F. M. 554 (569)
 PAYMAN, W. 398, 409, 410, 411, 412, 415 (495,
 496), 523 (527)
 PEACOCK, J. 16 (38)
 PEARSON, J. (287, 497)
 PEASE, R. N. 295 (320, 394), 547 (568)
 PELIZZARI, G. 25 (39)
 PELOUZE, J. H. 528 (567)
 PENNER, S. S. 295 (320, 687)
- PENNY, E. 227 (243)
 PERROTT, G. S. J. 412 (496)
 PHILIPPI, E. 326 (363)
 PHILIPS, R. 28 (39)
 PHILLIPS, L. 142, 143 (159), 203, 204 (241)
 PICARD, J. R. 20, 25 (38, 39)
 PIETRZYK, C. 221, 223 (242)
 PIETSCH, E. 228 (243)
 PIKE, H. H. M. 653, 671 (687)
 PILLICH, J. 83 (125), 284 (287)
 PIMENTEL, G. C. 164, 167 (197, 198)
 PIOBERT, G. 335 (363)
 PISKORZ, M. 221, 223 (242)
 PLATZ, G. M. 309 (320)
 PLUCIŃSKI, J. 202, 203, 204 (241)
 PODBELSKII, G. N. 526 (527)
 PODGORNOVA, A. A. (497)
 PONCHON 579, 581 (686)
 PONZIO, G. 205, 206 (241)
 POPPENBERG, O. 534 (568)
 PORGER, J. (199)
 PORTER, G. (198), 547 (568)
 PRAVDIN 161 (196)
 PRENTISS, A. M. 49 (75)
 PRETTRE, M. 428 (496), 546 (568)
 PRICE, D. 393 (394)
 PRING, J. N. 670 (687)
 PRITCHARD, E. J. 23 (39)
 PROTHERO, J. B. (320)
 PROUT, E. G. 142 (159), 224 (242)
 PROUT, F. S. 223 (242)
 PURGOTTI, A. 192 (200)
- QUELLET, C. (320)
 QUILICO, A. 206 (241)
- RABEK-GAWROŃSKA, I. 80 (125), 256 (286)
 RACIBORSKI, M. 307 (320)
 RAMACHANDRA RAO, C. N. (197)
 RASCHIG, F. 329 (363)
 RATHSBURG, H. 141 (159), 192 (200), 207 (241)
 RATOUIS 616 (686)
 RÄTZ, R. 190 (200)
 RAZORENOV, B. 8 (14)
 RECCHI, V. 22 (39, 569), 664 (687)
 RECKLEBEN, H. 228 (243)
 REESE, E. F. (243)
 REGAD, E. D. 48 (75)
 REICHARDT, H. 547 (568)
 REICHLER, W. T. 196 (200)
 REID, W. F. 529 (567)

- REISET 331 (363)
 REITZ, A. W. 164 (197)
 RICE, F. O. 167 (198)
 RICE, G. S. (495)
 RICHE, A. 227 (242)
 RICHTER (688)
 RIDEAL, E. K. 538 (568)
 RIE, G. (363)
 RIMARSKI, W. 226 (243)
 RINEHART, J. S. (287, 497)
 RINKENBACH, W. H. 48, 49, 50, 52, 58 (75),
 118 (126), 184, 195 (199, 200), 208,
 215, 226 (241, 242), 256 (286), 341
 (364), 484 (497)
 RINTOUL, W. 643 (687)
 RISSOM, J. 166, 185 (197)
 RITCHIE, M. 320
 ROBERTS, E. E. (126)
 ROBERTSON, A. J. B. 20 (38), 53 (75), 84, 118
 (125), 538 (568)
 ROBERTSON, R. 54 (75), 148 (160), 643 (687)
 RODMAN, T. J. 360 (364)
 ROGERS, G. F. 164 (197)
 ROGERS, G. T. 173, 182, 183 (199)
 ROGERS, R. N. 285 (287)
 ROGERS, T. A. 402 (495)
 ROGINSKII, S. Z. 53 (75), 381
 ROLLET, A. P. 421 (496)
 VAN ROMBURGH, P. 40, 42, 45, 46, 47, 52,
 63, 65, 67, 68, 70 (74, 75, 76)
 ROMOCKI, S. J. 129 (131), 322 (363, 567)
 ROSBAUD, P. (199)
 LE ROSEN, A. L. 2 (14)
 ROSENBERG 157 (160)
 ROSENQUIST, E. N. 210 (241)
 ROSIŃSKI, M. 552, 556 (569)
 ROSS, J. H. 109 (126)
 ROSSI, B. D. 424, 425 (496)
 ROSZKOWSKI, J. 544 (568)
 ROTH, G. 266, 269 (286)
 ROTH, I. F. 134 (158)
 ROTH, R. 206 (241)
 ROTH, W. A. 305 (320)
 ROTTWEIL 529
 LE ROUX, A. 254 (286), 505 (526)
 RÜHL, G. 393 (394)
 RUPE, H. 228 (243)
 RUSECKI, A. 191 (200)
 SAH, P. P. T. 26 (39)
 SABANEYEV, A. 169 (198), 228 (243)
 SAHLI, M. 178 (199)
 SALATHÉ, F. (74)
 SALCEWICZ, J. (569)
 SALVADORI, R. 230 (243)
 SALLYAMON, G. S. 3 (14)
 SANDISON, R. 224 (242)
 SAPOZHNIKOV, A. 553
 SARTORIUS, R. 273 (287), 290, 314 (319, 321),
 421 (496)
 SATTERFIELD, C. N. 305 (320)
 SAUNDERS, W. H. 196 (200)
 SAWKILL, J. 182 (199)
 SAYERS, J. 573 (686)
 SCHARFF, M. 121 (126)
 SCHEIBER, I. 228 (243)
 SCHENKEL, G. (687)
 SCHEPERS 46 (75)
 SCHIESSLER, R. W. 109 (126)
 SCHMIDT, A. 53 (75)
 SCHMIDT, F. 191 (200)
 SCHNURR 87, 95, 104
 SCHOLL, R. 8 (14), 140 (159)
 SCHÖNBEIN, C. F. 528 (567)
 SCHOWENGARDT, J. W. 675, 681 (687)
 SCHRADER, F. 192 (200)
 SCHROEDER, W. A. 2 (14), 563 (569)
 SCHUCK, M. 53, 63 (75)
 SCHULTZ, G. (76)
 SCHULTZ, R. D. 381, 391 (395)
 SCHULTZE, E. 528 (567)
 SCHUMACHER, H. J. 166 (197)
 SCHUMACHER, J. C. (321)
 SCHUMB, W. C. 305 (320)
 SCHWAEBEL, R. 168 (198)
 SCHWANKE, C. 456 (497)
 SCHWARTZ (363)
 SCHWEITZER, C. E. 18 (38)
 SCHWINN, E. 231 (243)
 SCHWOB, R. 299 (320)
 SCOTT, J. 306, 307, 310 (320)
 SCOTT, L. B. (126)
 SEEL, F. 168 (198)
 SEGAY 411 (496)
 SEIDLER, P. (363)
 SELEZNEV 432
 SELL, E. 567 (569)
 SELLE, H. 54 (75)
 SEMEŃCZUK, A. 42, 43, 72 (74, 75, 76)
 SEMISHIN, V. I. 305 (320)
 SEREBRYAKOV, M. E. (568), 673 (687)
 SHAH, S. 338 (363)
 SHAKHNOVSKAYA 161 (196, 197)

- SHANLEY, E. S. 300, 302, 304, 305 (320)
 SHEEHAN, J. C. 114 (126)
 SHEFFIELD, O. E. (243)
 SHEINKER, YU. N. 64, 163 (197)
 SHEKHTER, B. I. (160)
 SHEPHERD, W. C. F. 420 (496)
 SHERMAN, E. (39)
 SHISHKOV, L. 138 (159), 336 (363)
 SHORYGIN, P. P. 43 (75)
 SHPITALSKII, E. (276, 287)
 SIEGENS, S. 225, 226 (242)
 SIERSCH 398
 SILLITTO, G. P. 383 (394), 421 (496)
 ŠIMEČEK, J. 81, 82, 122, 123 (125, 127)
 SIMMONS, W. H. (126)
 SIMONS, J. H. (320)
 SINGH, K. 89 (126), 139, 143, 144 (159), 172, 187 (198, 199)
 SINYARYEV, G. B. 294, 298, 308, 309, 311 (319)
 SIROTINSKII, V. F. (160)
 SKRZYNECKI, J. 24 (39), 254, 257 (286)
 SMART, G. N. R. 11 (14)
 SMITH, L. C. (286)
 SMITH, P. A. S. (200)
 SMITH, T. L. 368 (394)
 SMOLEŃSKI, D. 46 (75), 202, 203, 204 (241)
 SNELLING, W. O. 233, 341 (364)
 SOCCI, M. 555, 559 (569)
 SOFIANOPOULOS, A. J. 166 (197)
 SOKOLNIK, A. S. (688)
 SOKOLOV, A. M. 56, 57, 59 (76)
 SOLONINA, A. 50, 135, 137, 138, 139 (159), 170 (198)
 SOMLO, F. 82 (125)
 SÖRENSEN, J. U. 162 (197)
 ŠORM, F. 192 (200)
 SOUBEIRAN (243)
 SPAETH, S. P. 227 (242)
 SPEAKMAN, J. C. (14, 38, 126)
 SPILL, D. 529 (567)
 SPRENGEL 278 (287), 288 (319)
 SPRINGALL, H. D. (125)
 ŠRAMEK 123 (127)
 STARKE, E. A. 335 (363)
 STASSART 398
 STEDMAN, G. 168 (198)
 STEIN, T. W. (320)
 STEINBERGER, R. 674, 675, 678 (687)
 STEINER, A. 140 (159)
 STEINER, K. 326 (363)
 STEINKOPF, W. 224 (242)
 STEPHAN 534 (568)
 STERN, R. 161 (196)
 STETTbacher, A. 148 (160), 214 (241), 282 (287), 311 (320)
 STEVENS, T. S. 7 (14)
 STEWART, K. 167 (197)
 STORCH, L. (14)
 STORM, C. 553 (569)
 STRASSER, E. 222 (242)
 STRAUMANIS, M. 185 (199)
 STRECKER, W. 231 (243)
 STREET (287)
 SUDLITZ, C. 607 (686)
 SUDO, H. 172, 174, 176 (199)
 SUGGITT, J. W. 11 (14)
 SUKHINSKII, A. V. 617 (686)
 SUNDERMEYER, W. 191 (200)
 SUTTON, G. P. 675, 676 (687)
 SVETLOV, L. G. 581 (686)
 ŚWIĘTOSŁAWSKI, W. 552, 556 (569)
 SYRKIN, YA. K. 163, 164 (197)
 SZYC-LEWAŃSKA, K. 53, 74 (75, 76), 106 (126), 203, 225 (241, 242)
 TABOUIS, F. 84 (125)
 TAFFANEL, J. 398, 425 (495, 496)
 TAIT, C. W. 296, 297 (320)
 TAMBURRINI, V. 256 (286)
 TANATAR, S. 169 (198)
 TATE, F. G. G. 324 (363)
 TAYLOR, C. 184, 195 (199, 200), 226 (242)
 TAYLOR, C. A. 49, 50, 52 (75), 256 (286), 484 (497)
 TAYLOR, G. B. 233
 TAYLOR, G. W. C. 174, 176 (199)
 TAYLOR, H. S. 295, 305 (320, 394)
 TAYLOR, J. (197), 217 (242), 324, 334 (363), 383 (394), 396, 397, 401, 413, 414, 415, 416, 419, 421, 422, 432, 433, 463, 464, 465, 466, 467, 468, 490 (495, 496, 497), 522, 524, 525 (527), 539 (568), 675 (687)
 TAYLOR, W. 55 (76)
 TAYLOR, W. G. 212 (241)
 TEODOROWICZ, K. 135 (158)
 TERPSTRA, P. 78 (125)
 TĘSIOROWSKI, E. 326 (363)
 THELEN, R. (363)
 VAN THIEL, M. 167 (198)
 THIELE, J. 15, 25, 34 (38, 39), 161, 169 (197, 198)
 THOMAS, A. T. 174, 176, 186 (199)
 THOMAS, H. 331, 340 (363)
 THOMAS, J. G. N. 171 (198)

- THOMAS, M. 122 (127)
 THORN, G. D. 2, 3 (13), 24 (39), 222 (242)
 THRUSH, B. A. 167 (198)
 TIBBITS, G. C. (687)
 TIFFANY, J. E. 212, 233 (241, 243)
 TIKHOMIROVA, A. (75), 256 (286)
 TITMAN, H. 414 (496)
 TOBOLSKY, A. V. (243)
 TODD, G. 139 (159), 171 (198)
 TOGGWEILER, U. (200)
 TOMPKINS, F. C. 142, 143, 145, 146 (159),
 163, 164, 171, 183, 184, 187, 188, 189
 (197, 198, 199), 216, 220, 224 (242)
 TONEGUTTI, M. 83, 84 (125), 559 (569)
 TOOMBS, L. E. (14), 36 (39)
 TOPCHIEV, A. V. 43 (75)
 TORMEY, J. F. 317 (321)
 TOWNE, E. B. (14)
 TOWNEND, D. T. A. 683 (688)
 TRAUBE, W. 2, 17 (38), 221, 222, 223 (242)
 TROUP, H. B. 56 (76)
 TRUEBLOOD, K. N. (569)
 TRUSH, B. A. (568)
 TSCHINKEL, J. G. 297, 299 (320)
 TUREK, O. 193 (200)
 TURNER, J. 42 (74)
 TURPIN, E. 288 (319)
 TURRENTINE, J. W. 169 (198)
- UBBELOHDE, A. R. 261 (286)
 ULRICH (76)
 URBAŃSKI, J. 73 (76)
 URBAŃSKI, T. 18, 24, 25, 30, 31, 34, 35, 37
 (38, 39), 42, 43, 53, 63, 66, 68, 73, 74
 (74, 75, 76), 79, 80, 83, 84, 85, 98, 106
 (125, 127), 191 (200), 203, 213, 215, 216,
 220, 221, 223, 224, 225 (241, 242), 249,
 250, 251, 254, 256, 257, 258, 259, 264,
 265, 278, 283, 284 (285, 286, 287), 326,
 327 (363), 409, 411, 434, 435, 436, 475
 (496, 497), 540, 552, 556, 566 (568, 569)
 URIZAR, M. J. (286)
- VALENTINUS, BASILIUS 129 (131)
 VÁRI, P. 256 (286)
 VASILEVSKII, V. V. 193 (200)
 VAUGHAN, J. 142, 143 (159), 203, 204 (241)
 VENKATARAMAN, A. 8 (14)
 VENNIN, L. 154 (160), 236, 237 (243, 527),
 609 (686, 687)
- VERLEGER, H. (197)
 VERNAZZA, E. 81 (125)
 VERNEUIL 229 (243)
 VERVOORST, P. 230, 231 (243)
 VIEILLE, P. 22, 30 (39), 138, 148 (159), 190
 (200), 201, 229 (240, 243), 340 (364),
 529, 530, 538, 541, 549, 550, 554, 557,
 558 (568, 569), 623, 664 (687)
 VILLIGER, V. 252 (242)
 VIOLETTE 325 (363)
 VOIGT, A. 330 (363)
 VOLKMANN, F. 529 (567)
 DE VRIES, J. H. 26 (39)
 VROOM, A. H. 88, 91, 94, 95 (126)
 VYSHNEGRADSKII, I. A. 359 (364)
- WADDINGTON, T. C. 164, 165, 167, 170, 183,
 186, 187, 188 (197, 198, 199)
 WAGNER, J. 164, 165 (197)
 WALDEN, P. 305 (320)
 WALDEN, R. J. 171 (198)
 WALKER, M. 134 (158)
 WALLBAUM, R. 141 (159), 172, 177 (198), 208,
 215 (241)
 WALSH, A. D. (320)
 WALTON, D. C. 535 (568)
 WARE, J. C., JR. 196 (200)
 WARREN, F. A. 309, 318 (320), 373, 374, 375,
 387 (393, 688)
 WATERLOT, L. (496)
 WATT, G. W. 33 (39)
 WATTEYNE, V. 398, 407 (496)
 WEISSER, H. R. 162 (197)
 WENNER, R. R. 305 (320)
 WENTWORTH, R. L. 305 (320)
 WESOŁOWSKI, T. 223 (242)
 WESSELS, G. 293, 294 (319)
 WESTWATER, R. (497)
 WETTERHOLM, A. 437, 482 (497)
 WHEELER, R. W. 416 (496)
 WHEELER, T. S. (200)
 WHEELER, W. H. 653, 671 (687)
 WHITE, A. G. 683, 684 (688)
 WHITMORE, F. E. 2 (13), 162 (197)
 WHITMORE, W. C. 120, 121 (126)
 WHITTAKER, A. E. 296, 297 (320)
 WHITTAKER, H. 653, 671 (687)
 WHITTLE, E. 167 (198)
 WIBERG, E. 190 (200)
 WIEGNER, G. 34 (39)
 WIELAND, H. 133, 134 (158, 159)

- WILDE, D. G. 414 (496)
WILDGOOSE, A. B. 468 (497)
WILKOSZEWSKI 398 (495)
WILL, W. 130, 340 (364), 398, 399 (495)
WILLIAMS 296, 297 (320)
WILLIAMS, H. L. 116 (126)
WILLIAMS, H. T. 172, 184 (199)
WILLIAMS, J. F. 28 (39)
WILLIAMS, M. C. 167 (198)
WILLIAMSON, W. O. 252 (285)
WILSON, G. L. 15 (38)
WINKLER, C. A. 82, 88, 91, 94, 95, 97, 109,
112, 116, 117, 118, 119 (125, 126),
173 (199)
WISCHIN, A. 182 (199)
WISLICENUS, W. 168 (198)
WITANOWSKI, M. 327 (363)
WITKOWSKI 56 (76)
WOGRINZ, A. 256 (286)
WÖHLER, L. 134, 135, 137, 158 (158, 159, 160),
170, 171, 173, 176, 185 (198), 201 (240)
WOJCIECHOWSKI, W. 25, 31, 34 (39)
WOLF, W. 529 (567)
WOLFF, L. 201 (241)
WOLFRAM 107
WOOD, W. S. 296, 302, 316 (320)
WOODBURY, C. A. 484 (497)
WOODCOCK, D. 7 (14, 126)
WOODHEAD, D. W. 446 (496, 497)
WORINGER, B. 211 (241)
WRIGHT 129 (131)
WRIGHT, G. F. 9, 10, 11 (14), 23, 25, 26, 27,
36 (39), 81, 88, 90, 91, 92, 108, 109,
114, 116, 117, 120, 123 (125, 126)
WRÓBEL, K. (687)
WRÓBLEWSKI, S. 288 (319)
WYLER, O. 256 (286)
YAMAMOTO, S. 469, 473 (497)
YAROSLAVSKII, N. G. 3 (14)
YEFREMOV, N. N. 52 (75), 256 (286)
YEGOROV, T. S. 588, 592, 610, 611 (686)
YOFFE, A. D. (159), 163, 164, 165, 169, 183,
186, 188, 191, 196 (197, 198, 199, 242)
YOKOGAWA, M. 424, 435, 436, 473 (496, 497)
YONCK 280 (287)
YOUNG, D. A. 143 (159), 164, 184, 189 (197,
199), 216, 220 (242)
YOUNG, G. H. S. (393)
YUILL, A. M. 139, 145 (159), 170, 171, 172,
176 (198, 199), 216 (242)
ZABUDSKII 538
ZACHAREWICZ, J. (38), 221, 223 (242)
ZAEHRINGER, A. J. 368, 393 (393), 629 (687)
ZAKHAROV, I. N. (686)
ZELDOVICH, YA. B. 537 (568)
ZIMMERMAN, G. A. 387, 388 (394)
ZINGARO, R. A. 214, 215, 216 (241)
ZUMSTEIN, O. (14)

SUBJECT INDEX

- Absorption towers for nitric oxides, 101
1-Aceto-3,5-dinitro-1,3,5-triazacyclohexane, 116
1-Aceto-3,5,7-trinitro-1,3,5,7-tetrazacyclooctane, 116
1-Acetoxyethyl-3,5-dinitro-1,3,5-triazacyclohexane, 114
1-Acetoxy-7-nitroxy-2,4,6-trinitro-2,4,6-triazahexane, 91
Acetylene, 227
Acetylides, 227
Aci-form,
 of nitramine, 16
 primary nitramines, 4
Activation energy of thermal decomposition,
 of cyclonite, 83
 ethylenedinitramine, 20
 lead azide, 172
 lead styphnate, 216
 lead styphnate dehydration, 216
 metal azides, 187
 octogen, 118
 silver azide, 184
 tetryl, 53
 thallium styphnate, 220
 thallous azide, 188
 triphenylmethyl azide, 196
Active ingredients in mining explosives, 423
Airdox charges, 526
Aliphatic nitramines—see Nitramines, aliphatic
Amatol 40/60, 261
Amatols, 261
Amines,
 in rocket propellants, 294
 mechanism of nitration, 11
 nitration of, by nitrolysis, 12
 secondary, nitration of, 9
 β -Aminoanthraquinone, nitration of, 8
Aminoguanidine derivatives, 206
Aminomethylnitramines, formation of, 7
N-Amino-N'-nitroguanidine, 28
 α -Aminopyridine, nitration of, 8
Aminotetrazole, 207, 210
Aminothiazole, nitration of, 8, 9
Ammelide, 29, 34
Ammeline, 29, 34
Ammonals, 268, 269
 composition of, 269
 German, 270
 USA, 270
Ammonites, 265, 405
Ammonium azide, 190
Ammonium chloride in mining explosives, 428
Ammonium nitrate, mixtures of, in rocket
 propellants, 383, 389
Ammonium nitrate-fuel oil mixtures, 489
 manufacture of, 508
Ammonium nitrate mining explosives, 447, 448,
 449, 450, 451, 452, 453, 454, 457, 458,
 459, 462, 465, 466, 467, 468, 470, 473,
 476, 477, 478, 481, 483
 manufacture of, 498
Ammonium picrate propellants, 393
Ammonium powder, 331
Aromatic nitramines—see Nitramines, aromatic
Azides,
 containing silicon, 196
 of "ammines", co-ordination compounds of,
 231
 organic, 191
Azidoguanidine, 210
5-Azidotetrazole, 208
Bachmann's reagent, 112
Ball-grain powder, 632
Ballistites, 647
 attenuated, 650
 manufacture of, 647

- Ballistites (*cont.*)
 progressive, 651
 Baratol, 264
 Barbaryt, 411
 Barium nitrocyanamide, 212
 Barium styphnate, 220
 Benzidine, nitro derivatives of, 46
 Benzotrifuroxane, 193
 Beryllium compounds in rocket propellants, 311
 Bis(acetoxymethyl)-nitramine, 114
 Bitetryl—see Hexanitrodiphenylethylenedi-nitramine
 Blackpowder, 323
 composition of, 324
 erosiveness of, 550
 explosive properties of, 340
 manufacture of, 342
 blending, 359
 corning, 354
 finishing, 357
 milling, 345
 mixing, 349
 pressing, 352
 safety in, 361
 theory of burning, 335
 types of, 328
 ammonium powder, 331
 chlorate powder, 334
 modified, 330
 picrate powder, 334
 sulphurless, 331
 Blasting caps—see Detonators
 Blasting powders, composition of, 329
 Bleitrizinat—see Lead styphnate
 Bobbinit, 404
 Boron compounds in rocket propellants, 311
 Bradyt F, 422, 434, 475
 Brattice drier, 155
 "BSX"—see 1,7-Diacetoxy-2,4,6-trinitro-2,4,6-triazaheptane
 Burning of blackpowder, theory of, 335
 Burning rate,
 of composite propellants for rockets, 392
 cyclonite, 86
 dinitrobenzenediazo-oxide, 204
 mercury fulminate, 147
 mixtures of tetranitromethane, 298, 299
 tetryl, 55
 sec-Butylnitramine, preparation of, 11
 Butyltetryl—see 2,4,6-Trinitrophenyl-n-butyl-nitramine
 Cadmium azide, 186
 Cambrite—see Carbonit
 Cannon powder, 360, 540
 Carbonit, 404
 Cardox charges, 522
 Casting, technology of, 676
 Cellulose, thermal decomposition of, 327
 Centralites, 447
 Centrifuges, 574
 Chain reactions, 547
 Charcoal, 325
 chemical structure of, 326
 for blackpowder manufacture, 345
 Cheddites, 277, 280, 403
 Chlorate powder, 334
 Chlorates,
 in mining explosives, 408, 422, 457, 458, 474
 of complex amines, 230
 of hydrazinometals, 231
 Chlorine trifluoride, 312
 in rocket propellants, 312
 Chloroformoxime, 133
 Coal-dust, explosibility of, 420, 421
 Coefficient of the vivacity, 530
 Collodion cotton, 511
 CP₁, 530
 CP₂, 530
 Combustibles in mining explosives, 423
 Complex amines, 230
 chlorates of, 230
 perchlorates of, 230
 Complex compounds of fulminic acid, 134
 Complex metal amines, 231
 Complex salts,
 of cupric azide, 185
 nitroguanidine, 31
 Composite explosives—see Explosives, composite
 Composition Exploding, CE—see Tetryl
 Compositions for explosive rivets, 240
 Cordite MD, manufacture of, 642
 Cordite Mk I, manufacture of, 642
 Cordite RDB, manufacture of, 643
 Cordites, 540
 Corning mills, 345, 355
 Cupric acetylde, 228
 Cupric azide, 185
 basic, 185
 complex salts of, 185
 Cuprous acetylde, 227
 Cyamelide, 134

- Cyanamide salts, 211
 Cyanuric acid, 120, 132
 salts of, 133
 Cyanuric triazide, 194
 Cyclonite, 77
 manufacture of, 87
 British method, 98
 E-method, 109
 German method, 104
 K-method, 105
 KA-method, 105
 W-method, 107
 toxicity of, 86
 Cyclotramethylenetetramine—see Octogen
 Cyclotrimethylenetrinitramine—see Cyclonite
 Cyclotrimethylenetrinitrosamine, 80
- DBX, 272
 DDNP—see Dinitrobenzenediazo-oxide
 Decomposition,
 of cyclonite, 81, 82
 kinetics of, 82
 hydrazine, 306
 hydrazoic acid, 167
 hydrogen peroxide, 301
 lead azide, 171
 lead styphnate, 215
 activation energy of, 216
 mercury fulminate, 142, 143
 rate of, 141
 methylenedinitramine, 17
 nitramines, 16
 nitroguanidine, 27
 primary nitramines, with alkalis, 4, 5, 6
 silver azide, 183
 kinetics of, 184
 tetryl, rate of, 52
- Desensitization—see Phlegmatization
 Detonation rate,
 of acetylene, 227
 Amatols, 261
 T-Ammonal, 269
 cupric azide, 185
 cyanuric triazide, 195
 cyclonite, 85
 Czechoslovakian mining explosives, 450,
 451
 dinitrodi-(β -hydroxyethyl)-oxamide dini-
 trate, 37
 dinitrodimethyldiamide of tartaric dinitrate,
 37
 dinitrodimethyloxamide, 35
 ethylenedinitramine, 20
 French mining explosives, 552, 553, 554
 Gelatine-Donarit 1, 456
 hexamethylenediamine peroxide, 226
 hexanitrodiphenylethylenedinitramine, 70
 Hungarian mining explosives, 469, 470
 Hydrobel, 490
 Japanese mining explosives, 472, 473, 474
 lead azide, 172
 lead styphnate, 218
 mercury fulminate, 147, 148
 nickel ammino perchlorate, 230
 nitroguanidine, 31
 oxyliquits, 492, 494
 Polish mining explosives, 476, 477, 478,
 479
 silver azide, 184
 tetryl, 54
 trimethylenetrinitrosamine, 124
 trinitrophenyl- β -hydroxynitraminoethyl
 nitrate, 71
 trinitrotriazidobenzene, 194
 USSR mining explosives, 485, 486, 487,
 488, 489
 Wetter-Astralit, 460
 Wetter-Carbonit, 460
- Detonator TAT-1, 233
 Detonators, 218, 232
 manufacture of, 236
 1,5-Diaceto-3,7-dinitro-1,3,5,7-tetrazacyclo-
 octane, 116
 1,5-Diaceto-3,7-endomethylene-1,3,5,7-tetraza-
 cyclo-octane, 116
 1,5-Diacetoxy-2,4-dinitro-2,4-diazapentane,
 115
 1,9-Diacetoxy-2,4,6,8-tetranitro-2,4,6,8-tetraza-
 nonane, 115
 1,7-Diacetoxy-2,4,6-trinitro-2,4,6-triazaheptane,
 91, 114
 Diazide of carbonic acid, 192
 Diazo compounds, 201
 oxidation of, 2, 13
 Diazomethane, reaction with primary nitr-
 amines, 7
 Diazonium nitrate, formation of, 7
 4-Diazo-1-oxide, 205
 nitro derivatives of, 205
 2-Diazo-1-oxide, 205
 nitro derivatives of, 205
 Diethanolnitramine dinitrate—see Nitrodietha-
 nolamine dinitrate

- 1-Di(hydroxymethyl)-aminomethyl-3,5-dinitro-1,3,5-triazacyclo-hexane, 90
- Diluter, 100
- "Dimazine"—see 1,1-Dimethylhydrazine
- Dimethylaniline,
nitration of, 41, 56
continuous method, 58
- Dimethylaniline sulphate, production of, 57
- 1,1-Dimethylhydrazine, in rocket propellants, 308
- 2,4-Di-(methylnitraminomethyl)-4-nitrophenol, 72
lead block expansion test of, 73
- DINA—see Nitrodiethanolamine dinitrate
- 2,6-Dinitro-4-amino-*m*-cresol, 205
diazo compound from, 205
- 2,6-Dinitro-2-amino-*m*-hydroxybenzoic acid, 205
diazo compound from, 205
- 2,4-Dinitro-2-aminoresorcinol, 205
diazo compound from, 205
- N,N'-Dinitroammeline, 120
- Dinitroazidophenol, 195
plumbous salt of, 196
- Dinitrobenzenediazo-oxide, 201
- 3,7-Dinitro-3,7-diaza-1,5-dioxacyclo-octane, 90
- 2,5-Dinitro-2,5-diazahexane, 3
- 3,5-Dinitro-3,5-diazapiperidinium nitrate, 91
- Dinitrodiazophenol—see Dinitrobenzenediazo-oxide
- Dinitrodiethylamide, 35
- Dinitrodi-(β -hydroxyethyl)-oxamide dinitrate, 37
- Dinitrodi-(β -hydroxyethyl)-sulphamide dinitrate, 38
- Dinitrodimethyldiamide of tartaric dinitrate, 37
- Dinitrodimethylamide, 34
- Dinitrodimethylsulphamide, 36
- 2,4-Dinitromethylaniline, nitration of, 44, 61
- Dinitrophenylmethylnitramine, rearrangement of, 5
- Dinitrosopentamethylenetetramine, 121, 124
- 3,5-Dinitroso-1,3,5,7-tetrazabicyclo[3,3,1]nonane—see Dinitrosopentamethylene-tetramine
- 3,5-Dinitro-1,3,5,7-tetrazabicyclo[3,3,1]nonane, 90
- 2,4-Dinitro-6[tetrazene-(1-)]-phenylhydrazine salt, 206
- 1,9-Dinitroxy-2,4,6,8-tetranitro-2,4,6,8-tetraza-nonane, 89
- Dinol—see Dinitrobenzenediazo-oxide
- Diphenylamine, as stabilizing agent in smokeless powder, 559
- Diphenylphenazine, 562
- Disk mill, 108, 346
- 1,3-Ditetrazyltriazine, 210
- Ditetryl—see 2,4,6-Trinitro-1,3-di(methylnitr-amino)-benzene or Hexanitrodiphenyl-ethylenedinitramine
- DNPT—see Dinitrosopentamethylenetetramine
- Donarit, 263
- Double base cast propellants, 675
- Double base powder, 641
- Double base powder for rockets, 671
- DPT—see 3,5-Dinitro-1,3,5,7-tetrazabicyclo [3,3,1]nonane
- Driers, 499, 500, 501, 502, 503, 504, 612, 613, 615
infrared, 638, 639
Mamut, 663
- Dynamites, 454, 457, 458, 459, 461, 469, 471, 472, 476, 479, 480, 481
manufacture of, 511
- Dynobel, 405
- Edge runners, 350, 351
- EDNA—see Ethylenedinitramine
- Elastomers in rocket propellants, 368, 380
- 1,5-Endomethylene-3,7-dinitro-1,3,5,7-tetraza-cyclo-octane—see Dinitrosopenta-methylenetetramine
- Energy of activation—see Activation energy
- Erosion bomb, 549
- Erosiveness,
of blackpowder, 550
blasting gelatine, 550
nitrocellulose powders, 550
nitroglycerine powders, 550
nitroguanidine, 550
smokeless powder, 548
- Ethylene-bis-acetamide, 19
- Ethylenediamine, reaction with nitroguanidine, 28
- Ethylenedinitramine, 18
homologues of, 21
- Ethylene oxamide, 19
- Ethylene oxide in rocket propellants, 310
- Ethyltetryl—see 2,4,6-Trinitrophenylethyl-nitramine
- Eutectic mixtures,
with cyclonite, 80
dinitrodimethylamide, 35
nitroguanidine, 24

- Expansion in the lead block test—see Lead block expansion test
- Explosibility of coal-dust, 420
- Explosion, heat of—see Heat of explosion
- Explosions in gas mixtures, 545
- Explosions of lead azide, 174
- Explosive complex compounds, 230
- Explosive mixtures, incompatibility of, 283
- Explosive properties,
 of blackpowder, 340
 composite propellants, 393
 cyclonite with TNT, 250
 dinitrobenzenediazo-oxide, 202
 dinitrodi-(β -hydroxyethyl)-sulphamide dinitrate, 38
 ethylenedinitramine, 20
 hydrogen peroxide, 304
 mercury fulminate, 146
 metal azides, 186
 nitroguanidine, 29
 PETN with TNT, 252
 smokeless powder, 532
 substances containing nitroguanidine, 30
 trimethylenetrinitrosamine, 123
- Explosives,
 composite, 245
 fusible, 247
 high, 247
 infusible, 258
 liquid, 286
 semifusible, 258
- Favier explosives, 403
- Flash, 544
- Flashless charges, 663
- Flashless powders, 663
- Fluorine, in rocket propellants, 312
- Fluorine compounds, in rocket propellants, 312
- Fluorine oxide, in rocket propellants, 312
- Formhydroxamic acid, 158
- Fp 60/40—see Amatol 60/40
- Free atoms, reaction of, 316
- Free radicals, reaction with hydrogen, specific impulse of, 318
- Fuels, mixtures with, in rocket propellants, 293
- Füllpulver 60/40—see Amatol 60/40
- Fulminate ion, 133
 structure of, 133
- Fulminic acid, 132
 complex compounds of, 134
 polymerization of, 134
 salts of, 133, 157
- Furfuryl alcohol in rocket propellants, 294
- Furoxanedialdoxime, 133
- Fusible explosives, 247
- Fusible mixtures,
 manufacture of, 255
 phlegmatization of, 257
- Galleries for testing—see Testing galleries
- Gallery testing of explosives, application of statistics in, 445
- Gelatine-Donarit 1, 655
- Gelignites, 461
- Guanyl azide, 207
- Haleite—see Ethylenedinitramine
- Halogen azides, 191
- HBX, 272
- Heat of combustion,
 of cyclonite, 78
 1,1-dimethylhydrazine, 308
 hydrazine, 305
 tetryl, 49
 trimethylenetrinitrosamine, 122
- Heat of decomposition,
 of mercury fulminate, 148
 metal azides, 189
- Heat of detonation,
 of cyclonite, 84, 85
 mining explosives, 429, 469, 470, 485, 486, 487, 488, 489
 trimethylenetrinitrosamine, 122
 Wetter-Astralit, 460
 Wetter-Carbonit B, 460
- Heat of explosion,
 of ethylenedinitramine, 20
 Gelatine-Donarit 1, 456
 mercury fulminate, 148
 oxyliquits, 492
 smokeless powders, 536
 tetrazene, 208
 tetryl, 54
- Heat of formation,
 of acetylene, 227
 ammonium azide, 190
 chlorine trifluoride, 312
 cyanuric triazide, 195
 cyclonite, 78
 dinitrobenzenediazo-oxide, 204
 fluorine oxide, 312

- Heat of formation (*cont.*)
 of hydrazine, 305
 hydrogen peroxide, 300
 mercury fulminate, 148
 metal azides, 187
 nitrogen selenide, 229
 nitrogen sulphide, 229
 perchloric acid, 313
 perchloryl fluoride, 313
 silver acetylide, 229
 tetryl, 49
 trimethylenetrinitrosamine, 122
- Heat of nitration,
 of hexamethylenetetramine, 95
 hexamethylenetetramine dinitrate, 95
 hexamethylenetetramine nitrate, 95
- Heat of vaporization of hydrogen peroxide, 300
- Heat, specific,
 of cyclonite, 78
 hydrogen peroxide, 300
 mercury fulminate, 139
 tetryl, 49
- Heterocyclic nitramines—see Nitramines, heterocyclic
- Hexamethylenediamine peroxide, 225
 chemotherapeutic action of, 226
- Hexamethylenetetramine,
 action of nitric acid on, 87
 nitration of, 13
 rate of, 94
- Hexamine—see Hexamethylenetetramine
- Hexanitrodiphenylethylenedinitramine, 69
- Hexanitrodiphenyl- β -hydroxynitraminoethyl nitrate, 72
- N-2,3,4,5,6-Hexanitro-N-methylaniline—see 2,3,4,5,6-Tetranitrophenyl-N-methylnitramine
- Hexanitrosobenzene—see Benzotrifuroxane
- 3,5,3',5',3'',5''-Hexanitro-4,4',4''-tri(methylnitramino)-triphenylcarbinol, 68
- Hexogen—see Cyclonite
- High explosives, 247
 mixtures,
 with aluminium and ferro-silicon, 272
 chlorates and perchlorates, 274
 metals, 266
 mixtures of nitrocompounds, 247
- HMTD—see Hexamethylenediamine peroxide
- HMX—see Octogen
- Homocyclonite, 119
- Homohexogen—see Homocyclonite
- Hydrazine, 306
 decomposition of, 306
 in liquid explosives, 295
 in rocket propellants, 305
 oxidation of, 307
- Hydrazoic acid, 161
 manufacture of, 168
- Hydrobel, 490
- Hydrogen peroxide, 300
 in liquid explosives, 290
 in rocket propellants, 299
 thermochemical properties, 303
- Hydrox charges, 523
- Ignitability of smokeless powder, 541
- Ignition temperature,
 of charcoal, 325
 cyanuric triazide, 195
 cyclonite, 83
 dinitrodi-(β -hydroxyethyl)-oxamide dinitrate, 37
 dinitrodimethyldiamide of tartaric dinitrate, 37
 ethylenedinitramine, 20
 hexanitrodiphenyl- β -hydroxynitraminoethyl nitrate, 72
 lead styphnate, 215
 metal azides, 189
 methylenedinitramine salts, 221
 nitrogen selenide, 229
 octogen, 118
 silver azide, 184
 thallos azide, 188
 tetryl, 53
 2,4,6-trinitro-1,3-di(methylnitramino)-benzene, 66
 2,4,6-trinitro-3-methylnitraminoanisole, 65
 2,4,6-trinitro-3-methylnitraminophenetole, 65
 2,4,6-trinitro-3-methylnitraminophenol, 65
- Incompatibility of explosive mixtures, 283
- Inert ingredients in mining explosives, 427
- Inert neutralizing agents in mining explosives, 433
- Inflammability of solvents, limits of, 684
- Infusible explosives, 258
- Initiating ability of priming explosives, 158
- Initiating compositions, 232
- Initiating properties of dinitrobenzenediazoxide, 204
- Initiation temperature,
 of basic cupric azide, 185

- Initiation temperature (*cont.*)
 of fulminates, 157
 lead azide, 172
 metal azides, 186
- Initiators, 129
- Ionic structure of phenyldiazonium nitroformate, 205
- Isocyanuric acid, 133
- "Isonitramines"—see Nitrosohydroxylamines
- KMA mixtures, 271
- Kneaders, 586, 587, 588, 589
- "L-alloy", 248
- Lead azide, 169
 basic, 178
 manufacture of, 178
 continuous method, 179
 neutral, 169
 allotropic forms of, 169
- Lead block expansion test, 85
 of acetylene, 227
- Amatols, 261
- 2,4-di-(methylnitraminomethyl)-4-nitrophenol, 73
- dinitrodiethyloxamide, 35
- dinitrodi-(β -hydroxyethyl)-oxamide dinitrate, 37
- dinitrodimethyldiamide of tartaric dinitrate, 37
- dinitrodimethyloxamide, 35
- dinitrodimethylsulphamide, 36
- Gelatine-Donarit 1, 456
- hexanitrodiphenylethylenedinitramine, 70
- mercury fulminate, 148
- metal azides, 189
- metazonic acid, 224
- mining explosives, 429, 450, 451, 452, 453, 454, 469, 470, 472, 473, 474, 476, 477, 478, 479, 485, 486, 487, 488, 489
- nitrourea, 34
- octogen, 119
- oxyliquits, 492
- Perdit, 264
- tetryl, 54
- trimethylenetrinitrosamine, 124
- 2,4,6-trinitrophenylethylnitramine, 67
- trinitrophenyl- β -hydroxynitraminoethyl nitrate, 71
- trinitrotriazidobenzene, 194
- 2,4,6-trinitro-1,3,5-tri(methylnitramino)-benzene, 67
- Wetter-Astralit, 460
- Wetter-Carbonit B, 460
- Lead dinitroresorcinate, 220
- Lead picrate, 212
- Lead rhodanate, 230
- Lead styphnate, 213
- Lead trinitroresorcinate—see Lead styphnate
- Lignin, thermal decomposition of, 327
- Liquid explosives, 286
 mixtures with
 hydrogen peroxide, 290
 nitric acid, 290
 nitrogen dioxide, 289
 tetranitromethane, 290
- Liquid oxygen explosives—see Oxyliquits
- Macarit, 264
- Manufacture,
 of ammonium nitrate-fuel oil mixtures, 508
 ammonium nitrate mining explosives, 498
 ammonium nitrate powder for rockets, 386
 ballistites, 647
 safety in, 651
 barium azide, 190
 blackpowder, 342
 chlorate and perchlorate explosives, 520
 Cordite MD, 643
 Cordite Mk I, 643
 Cordite RDB, 644
 cyclonite, 87
 E-method, 109
 K-method, 105
 KA-method, 111
 W-method, 107
- detonators, 236
- dynamites, 511
- fusible mixtures, 255
- hydrazoic acid, 168
- lead azide, 178
 continuous method, 179
- lead styphnate, 218
 continuous method, 219
- mercury fulminate, 149
- mining explosives, 498
- nitrocellulose powder, 573
- nitroguanidine, 32, 33
- rocket charges, 373
- salts of hydrazoic acid, 168
- smokeless powder, 570

- Manufacture (*cont.*)
of smokeless powder, safety in, 682
solventless powder,
in German factories, 660
with low content of nitroglycerine, 652
tetrazene, 209
tetryl, 56
- Mechanism,
of amines nitration, 11
cyclonite decomposition, 81, 82
dimethylaniline nitration, 41
N-methyl-N'-nitroguanidine formation, 27
nitramines nitration, 11
phenyl azide formation, 162
triphenylmethyl azide decomposition, 196
- Melamine nitro derivatives, 120
- Mercaptans in rocket propellants, 295
- Mercuric azide, 186
- Mercuric oxalate, 224
- Mercurous azide, 186
- Mercury fulminate, 135
manufacture of, 149
reactions with metals, 140
sensitiveness to sunlight, 146
storage of, 153
toxicity of, 153
- Metafulminuric acid, 134
- Metal azides, 186
- Metals, powdered, in rocket propellants, 311
- Metanits, 410, 450
- Metazonic acid, 224
salts of, 224
- Methylamine, nitration of, 10
- Methylenedi-isonitramine, 17, 18
sodium salt of, 221
thallous salt of, 223
- Methylenedinitramine, 17
homologues of, 17
salts of, 221
- O-Methyl-methylnitramine, 4
hydrolysis of, 4
- Methylnitramine, 16, 51
- N-Methyl-N'-nitroguanidine, mechanism of formation, 27, 28
- N-Methylpicramide, 41, 51, 52
- Methyl polymethacrylate in rocket propellants, 381
- Methyltetryl—see 2,4,6-Trinitro-3-methylphenyl-methylnitramine
- Miedziankit, 403, 408, 422, 475
- Minimum ignition temperature of mining explosives, 428
- Minimum initiating charges,
of lead azide, 177, 233
lead azide-lead styphnate mixtures, 233
lead styphnate, 177, 233
mercury fulminate, 177
metal azides, 186
picric acid, 72
silver azide, 177
tetrazene, 177
tetryl, 72
trinitrophenyl- β -hydroxynitraminoethyl nitrate, 72
trinitrotoluene, 72
- Mining explosives, 395
Belgian, 404, 447, 449, 450
British, 405, 461, 462, 463, 464, 465, 466, 467, 468
chlorate and perchlorate, 408, 457, 458, 474
manufacture of, 520
components of, 420
Czechoslovakian, 448, 450
French, 403, 451, 452, 453, 454
German, 406, 408, 455, 456, 457, 458, 459, 460
Hungarian, 468, 469
Japanese, 468, 469, 470, 471, 472, 473, 474
inert neutralizing agents in, 433
manufacture of, 498
non-permitted, 461
permitted, 461
Polish, 475, 476, 477, 478, 479
sheathed, 461
stability of, 446
tests for, 433
U.S.A. 480, 481, 482, 483, 484
U.S.S.R. 484, 485, 486, 487, 488, 489
- Mixtures,
fusible,
gaseous, with hydrazine, 307
manufacture of, 255
phlegmatization of, 257
of Amatols with cyclonite, 263
cyclonite with TNT, 249
PETN with TNT, 251
S-type, 271
- MNO—see Dinitrodimehyloxamide
- Monobel, 404
- Muzzle flame, 544
- NENO—see Dinitrodi-(β -hydroxyethyl)-oxamide dinitrate
- Nickel ammino perchlorate, 230

- Nitramide-- see Nitramine
- Nitramine salts, 221
- Nitramines, 1
- aliphatic, 15
 - aromatic, 40
 - aromatic-aliphatic, denitration of, 5
 - bond angles in, 2
 - heterocyclic, 77
 - interatomic distances in, 2
 - preparation of, through chloramines, 11
 - mechanism of, 11
 - reduction of, 6
- Nitramines, primary,
- acidic properties of, 4, 16
 - aci-form of, 4
 - decomposition in sulphuric acid, 4, 5
 - decomposition with alkalis, 6
 - reaction with diazomethane, 7
- Nitramines, secondary,
- decomposition in sulphuric acid, 4
 - decomposition with alkalis, 6
- Nitramino-azoxy compounds, 73
- Nitramino-esters of nitric acid, 70
- Nitramino group, structure of, 2
- Nitraminonitrophenols, 72
- Nitrates in mining explosives, 421
- Nitration,
- of amines
 - by nitrolysis, 12
 - mechanism of, 11
 - β -aminoanthraquinone, 8
 - α -aminopyridine, 8
 - aminothiazole, 8, 9
 - dimethylaniline, 41, 56
 - continuous method of, 58
 - 2,4-dinitromethylaniline, 44, 61
 - hexamethylenetetramine, 13, 94
 - methylamine, 10
 - primary amines, by acylation, 10
 - secondary amines, 9
 - 2,4,6-tribromoaniline, 9
- Nitrator, continuous, 99
- Nitrator control panel, 100
- Nitric acid, mixtures with,
- in liquid explosives, 290
 - in rocket propellants, 292
- Nitric esters in rocket propellants, 309
- Nitroaliphatic compounds on smokeless powder, 671
- 5-Nitro-3-aminosalicylic acid, 205
- diazo compound from, 205
- Nitroammelide, 120
- 5-Nitro-3-azidosalicylic acid, 195
- plumbous salt of, 196
- Nitrocellulose,
- dehydration of, 573, 574, 576
 - dissolution of, 583
- Nitrocellulose bulk powder, 640
- Nitrocellulose mixtures preparation, 582
- Nitrocellulose powder, 541
- manufacture of, 573
 - stability of, 555
- Nitrocompounds, mixtures of, 247
- Nitrocyanamide, 21
- salts of, 211
- N-Nitro-N',N''-diacetyl melamine, 121
- Nitroethane in rocket propellants, 296
- Nitroformoxime, 158
- Nitrogen dioxide, mixtures with,
- in liquid explosives, 289
 - in rocket propellants, 291
- Nitrogen selenide, 229
- Nitrogen sulphide, 229
- Nitroglycerine powders, 541
- solventless, 544
 - stability of, 556
 - with a volatile solvent, 642
- Nitroguanidine, 22
- complex salts of, 31
 - manufacture of, 32, 33
 - reaction with ethylenediamine, 28
 - tautomeric forms of, 22
- Nitroguanyl azide, 28
- Nitrolysis, 12
- Nitromethane in rocket propellants, 296
- Nitro Methylene Blue, 73
- Nitromethylisonitramine salts, 223
- Nitronium ion, 12, 26
- Nitroparaffins in rocket propellants, 296
- Nitrophenol salts, 212
- 2-Nitropropane in rocket propellants, 297
- Nitrosamines, 121
- N-Nitrosodiphenylamine, 562
- Nitrosoguanidine, 210
- Nitrosohydroxylamine derivatives, 1
- Nitrosohydroxylamine salts, 221
- Nitrosophenol salts, 221
- m*-Nitrotetryl -- see 2,3,4,6-Tetranitrophenylmethylnitramine
- Nitrourea, 33
- salts of, 34
- Non-permitted mining explosives--see Mining explosives, non-permitted
- Non-volatile solvents, 645

- Octogen, 90, 109, 117
- Octyl—see Hexanitrodiphenylethylenedinitramine
- Organic azides—see Azides, organic
- Organometallic compounds, in rocket propellants, 312
- Oxalic acid, 224
salts of, 224
- Oxamidoazide, 192
- Oxygen balance in mining explosives, 423
- Oxygen carriers in mining explosives, 421
- Oxygen, liquid, in rocket propellants, 309
- Oxyliquits, 290, 491
- Ozone, in rocket propellants, 309
- 2,3,4,5,6-Pentanitrophenyl-N-methylnitramine, 65
- Penthrite, in smokeless powder, 670
- Pentryl—see Trinitrophenyl- β -hydroxynitraminoethyl nitrate
- Pentyl—see Trinitrophenyl- β -hydroxynitraminoethyl nitrate
- Perchlorates,
in mining explosives, 422
of complex amines, 230
- Perchloric acid, in rocket propellants, 313
- Perchloryl fluoride, in rocket propellants, 313
- Perdit, 264
- Permitted mining explosives—see Mining explosives, permitted
- Peroxides, 225
- Phenyl azide, 162
- Phenyldiazonium nitroformate, 205
- Phenyl-O-methylnitramine, 7
- Phenylnitramine, 2
- Phenylnitrosohydroxylamine, 2
- Phlegmatization of cyclonite, 113
- Phlegmatizing substances, 257, 276
- “Phosphorous” azide, 191
- Picrate powder, 334
- Picratol, 266
- Picryl azide, 192
- Picrylmethylnitramine—see Tetryl
- Plastic explosives, 281
- Plastics, in rocket propellants, 381
- Polymerization of fulminic acid, 134
- Potassium chlorate, 274
- Potassium chloride in mining explosives, 428
- Potassium nitrocyamide, 211
- Power of explosives, 439
- Preparation,
of sec-butylnitramine, 11
cyclonite, 13
ethylenedinitramine, 18, 19
methylenedinitramine, 17
nitramine, 16
nitramines, 8
through chloramines, mechanism of, 11
nitrodiethanolamine dinitrate, 36
primer compositions, 235
tetryl, 47
general rules of, 47
- Presses, 576, 577, 578, 581, 590, 593, 594, 595, 596, 658
- Primary amines—see Amines, primary
- Primary explosives—see Initiators
- Production,
of ethylenedinitramine, 19
dimethylaniline sulphate, 57
- Propergols—see Rocket propellants, liquid
- Pyronite—see Tetryl
- Rate of detonation—see Detonation rate
- Rate of nitration of hexamethylene tetramine, 94
- X-Ray analysis,
of dimethylnitramine, 2
ethylenedinitramine, 2
- X-Ray investigation of azides structure, 161
- RDX—see Cyclonite
- Reduction of nitramines, 6
- Rocket propellants,
cast, 675
German, 681
composite, 365, 392
mixing of ingredients in, 389
mixtures of perchlorates with plastics, 380
mixtures with ammonium nitrate, 383, 389
thiokol propellants, 369
liquid, 291
composition of, 317
cryogenic liquids, 319
properties of, 296
storable liquidis, 319
with amines, 294
with beryllium compounds, 311
with boron compounds, 311
with ethylene oxide, 310
with fluorine compounds, 312
with fuels, 293
with fufuryl alcohol, 294

- Rocket propellants, liquid (*cont.*)
 with hydrazine, 295, 305
 with hydrogen peroxide, 299
 with liquid oxygen, 309
 with mercaptans, 295
 with nitric esters, 309
 with nitrogen dioxide, 291
 with nitroparaffins, 296
 with organometallic compounds, 312
 with ozone, 309
 with perchloric acid, 313
 with powdered metals, 311
 with silicon compounds, 311
 with surface-active substances, 295
- Safety explosives,
 in the U.S.A. 484
 U.S.S.R. 489
- Safety,
 in ballistites manufacture, 651
 in blackpowder factories, 361
 in smokeless powder manufacture, 682
- Safety increasing ingredients, in mining explosives, 427
- Safety of mining explosives, 396
- Safety tests for mining explosives, 439
 in Japan, 472
- Safety testing,
 in the presence of coal-dust, 445
 in the presence of methane, 441
- Saltpetre, for blackpowder manufacture, 342
- Saltpetre, Chilean, for blackpowder manufacture, 344
- "SH-Salz", 105
- Saxonite, 404
- Schnéiderite, 260
- Schultze powder—see Nitrocellulose bulk powder
- Semifusible explosives—see Explosives, semifusible
- Sensitiveness to detonation,
 of smokeless powder, 540
 test for, 434
- Sensitiveness to impact,
 of barium azide, 189
 basic cupric azide, 185
 cupric azide, 185
 cyclonite, 86
 dinitrobenzenediazo-oxide, 204
 fulminates, 157
 lead azide, 172, 176
- Sensitiveness to impact (*cont.*)
 of mercury fulminate, 148
 metal azides, 186
 mixtures with ammonium nitrate, 262
 octogen, 118
 phlegmatizing substances, 276
 silver azide, 184
 smokeless powders, 541
 tetryl, 54, 55
 trimethylenetrinitrosamine, 124
 2,4,6-trinitro-3-methylnitraminoaniline, 65
 2,4,6-trinitro-3-methylnitraminoanisoole, 65
 2,4,6-trinitro-3-methylnitraminophenetole, 65
 2,4,6-trinitro-3-methylnitraminophenol, 65
 trinitrophenyl- β -hydroxynitraminoethyl nitrate, 71
- Sensitiveness to γ -radiation of mercury fulminate, 146
- Sensitiveness to sunlight of mercury fulminate, 146
- Sensitiveness to ultra-violet light of mercury fulminate, 146
- Sheathed mining explosives—see Mining explosives, sheathed
- Silicon compounds in rocket propellants, 311
- Silver acetylide, 229
- Silver azide, 182, 184
 decomposition of, 183
 kinetics of, 184
- Silver cyanamide, 211
- Silver fulminate, 157
- Silver nitrocyanoamide, 212
- Silver oxalate, 224
- Silver perchlorate, 232
- Silily-azides, 191
- "Sinoxyd", 218, 235
- Smoke formation, 548
- Smokeless powder, 528
 erosiveness of, 548
 for rockets, 671
 manufacture of, 570
 waste products in, 631
 stability of, 550
 stabilization of, 559
 with nitroaliphatic compounds, 671
 with penthrite, 670
- Sodium nitrate in mining explosives, 428
- Solubility,
 of cyclonite, 79, 80
 ethylenedinitramine, 20
 mercury fulminate, 138

- Solubility (*cont.*)
of tetryl, 50
trimethylenetrinitrosamine, 122
- Solventless powder,
in Japan, 663
manufacture of, in German factories, 660
with low content of nitroglycerine, manufacture of, 652
- Solvent recovery in smokeless powder manufacture, 599
- Specification for cyclonite, German, 105
- Specific heat—see Heat, specific
- Specific impulse, 312
of composite propellants for rockets, 392
mixtures for rocket propellants, 381
- Specific pressure,
of ammonium azide, 190
cyclonite, 84
mercury fulminate, 148
nitroguanidine, 30
- Spectra,
electronic,
of hydrazoic acid derivatives, 163
infrared,
of azides, 162
charcoal, 327
hydrazoic acid, 164
hydrazoic acid derivatives, 164
metal azides, 165
- Raman,
of azides, 162
hydrazoic acid derivatives, 164
metal azides, 165
- rotational,
of azides, 162
- ultraviolet,
of ethylenedinitramine, 3
2,5-dinitro-2,5-diazahexane, 3
methylenedi-isonitramine, 222
nitramines, 2, 3
nitroguanidine, 25
- Spectrographic analysis of hydrazoic acid derivatives, 163
- Spent acid,
in cyclonite manufacture, 108
dinitromethylaniline nitration, 62
- Stability,
of mining explosives, 446
nitrocellulose powder, 555
nitroglycerine powder, 556
nitroguanidine, 27
smokeless powder, 550
- Stability tests for smokeless powder, 557
- Stabilization,
of nitrocellulose powder, 632
smokeless powder, 559
with diphenylamine, 559
with inorganic stabilizers, 563
with organic stabilizers, 564
- Stabilizers, for smokeless powder,
apparent, 567
inorganic, 563
organic, 564
- Storage of mercury fulminate, 153
- Sulphur, for blackpowder manufacture, 344
- Sulphurless powder, 331
- Surface-active substances in rocket propellants, 295
- Surface gelatinization of the nitrocellulose powder, 624
- Temperature of explosion,
of acetylene, 227
ammonium azide, 190
cyclonite, 84
dinitrobenzenediazo-oxide, 204
mercury fulminate, 148
nitroguanidine, 30
- Temperature of ignition—see Ignition temperature
- Temperature of initiation—see Initiation temperature
- Teneres—see Lead styphnate
- Testing galleries, 409, 413, 415, 416, 417, 418, 419, 439, 440, 441, 442, 443, 444, 463
for mining explosives, 397
- Tetra-azido quinone, 192
- Tetralita—see Tetryl
- Tetralite—see Tetryl
- Tetramethylenediperoxidodicarbamide, 226
- 3,3',5,5'-Tetranitro-bis(4,4'-nitromethylamino)-azoxybenzene, 73
- 3,5,3',5'-Tetranitro-4,4'-di(methylnitramino)-benzophenone, 68
- Tetranitromethane,
as oxidant, 297
in liquid explosives, 290
in rocket propellants, 297
- N-2,4,6-Tetranitro-N-methylaniline—see Tetryl
- 2,3,4,6-Tetranitrophenylmethylnitramine, 63
derivatives of, 63
- 1,3,5,7-Tetranitro-1,3,5,7-tetrazacyclo-octane—see Octogen
- Tetraphenylhydrazine, 562

- Tetrazene, 206
 manufacture of, 209
 Tetrazolylguanyltetrazenehydrate—see Tetrazene
 Tetryl, 42
 homologues of, 62
 polycyclic analogues of, 68
 preparation of, 42
 general rules for, 47
 Tetrylit—see Tetryl
 Thallium styphnate, 220
 Thallous azide, 188
 Thiokol, liquid, 369
 manufacture of rocket charges with, 373
 Thiokol propellants, 368
 TMTN—see Trimethylenetrinitrosamine
 Tolyltetryl—see 2,4,6-Trinitro-3-methylphenyl-
 methylnitramine
 Torpex, 271
 Toxicity,
 of cyclonite, 86
 hydrazine, 307
 mercury fulminate, 149
 tetryl, 56
 Transmission of detonation test, 434
 Trialen, 271
 1,3,5-Triazacyclohexanetrissulphonic acid, 108
 Triazide of trimesic acid, 192
 Triazidonitrosaminoguanidine, 207
 Triazoethanol nitrate, 191
 2,4,6-Tribromoaniline, nitration of, 9
 N,N',N''-Trichloro-cyclotrimethylenetriamine,
 81
 2,4,6-Tri-(dimethylaminomethyl)-phenol, 72
 Trimethylenetriamine sulphate, 122
 Trimethylenetrinitrosamine, 121
 Trinitrobenzoyl azide, 193
 2,4,6-Trinitro-1,3-di(methylnitramino)-benzene,
 65
 2,4,6-Trinitrodiphenylamine, 51
 1,3,5-Trinitrohexahydro-sym-triazine—see Cy-
 clonite; trimethylenetrinitrosamine
 Trinitro-N-methylaniline, 5
 2,4,6-Trinitro-3-methylnitraminoaniline, 64
 2,4,6-Trinitro-3-methylnitraminoanisole, 64
 2,4,6-Trinitro-3-methylnitramino-N-methylaniline,
 64
 2,4,6-Trinitro-3-methylnitraminophenetole, 64
 2,4,6-Trinitro-3-methylnitraminophenol, 64
 2,4,6-Trinitro-3-methylphenylmethylnitramine,
 62
 2,4,6-Trinitrophenyl-n-butylnitramine, 67
 2,4,6-Trinitrophenylethylnitramine, 67
 Trinitrophenyl- β -hydroxynitraminoethyl nitrate,
 70
 2,4,6-Trinitrophenylmethylnitramine—see Tetryl
 1,3,5-Trinitro-1,3,5-triazacyclohexane—see Cy-
 clonite
 Trinitrotriazidobenzene, 193
 2,4,6-Trinitro-1,3,5-tri(methylnitramino)-ben-
 zene, 66
 Triphenylmethyl azide, 196
 Tritetryl—see 2,4,6-Trinitro-1,3,5-tri(methyl-
 nitramino)-benzene
 Tritonal, 272
 Trizinat—see Lead styphnate
 T4—see Cyclonite

 UDMH—see 1,1-Dimethylhydrazine

 Vacuum driers, for mercury fulminate, 153,
 154
 Vacuum filters, continuous, 101
 Viking Powder, 405, 410

 Waste substances,
 in mercury fulminate manufacture, 156
 in smokeless powder manufacture, 631

 Yonckites, 447

ERRATA TO VOLUMES I AND II

The author regrets that a few errors occurred in Volumes I and II.

Volume I

p. 15, eqn. (20) should read:

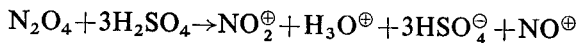

p. 41: the formulas should be replaced by the following:

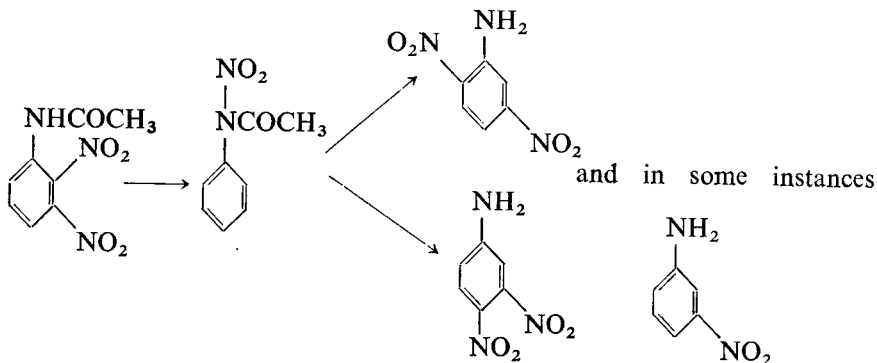

p. 77: the bottom formula should be replaced by the following:

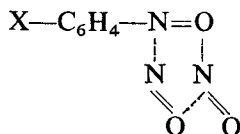

p. 82, lines 11-12 should read:

Wieland [13] of the formation of fulminic acid ...

p. 97, line 7 from the bottom should read:

According to Wieland [79, 79a], the reaction ...

p. 97, last line of the page should read:

1,4-diphenylbutadiene is converted to 1,4-diphenyl-1,4-dinitrobutylene-2 (IX) [79b]:

p. 98, line 8 should read:

Subsequently Wieland [79c] found ...

p. 98, paragraph (3) should read:

(3). The phenyl group when treated with N_2O_4 underwent nitration:

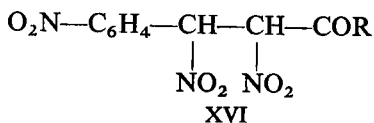

In such a way ...

p. 99, line 13 from the bottom should read:

Shechter and Conrad [49] ...

p. 109, line 13 should read:

On the basis of eqns. (44) and (45) ...

p. 133:

reference 12a should be corrected to 13, reference 13 should be corrected to 14, reference 14, H. Wieland and L. Semper, *Ber.* **39**, 2522 (1906) should be cancelled.

p. 135, reference 79 should read:

H. Wieland and E. Blümich, *Ann.* **424**, 75 (1921).

New references should be inserted:

79a. H. Wieland, F. Rahm and F. Reindel, *Ber.* **54**, 1770 (1921).

79b. H. Wieland and H. Stenzel, *Ber.* **40**, 4825 (1907); *Ann.* **360**, 299 (1908).

79c. H. Wieland, *Ann.* **328**, 154 (1903).

p. 176, lines 6-4 from the bottom should read:

	CCl_4	CCl_3CN
asymmetric vibr.	1506 cm^{-1}	1496 cm^{-1}
symmetric vibr.	1332 cm^{-1}	1320 cm^{-1}

p. 179, line 14 from the bottom should read:

Holder and Kline [38], Schmidt, Brown and D. Williams [40] ...

p. 618 (Author Index)

Schechter H. should be cancelled and on p. 619 items 92, 99 (134, 600) should be added to Shechter H.

Volume II

p. 165, lines 10-14 should read:

The boiling point of isopropyl nitrate is 101-102°C. It was originally believed that the substance can only be obtained from isopropyl iodide and silver nitrate [1]. Direct nitration is difficult due to oxidation at the carbon atom carrying the secondary hydroxyl group.

However a process for the continuous nitration of isopropyl alcohol in the presence of urea has been described in Imperial Chemical Industries patents [20]. Isopropyl alcohol and urea was introduced into nitric acid (over 40% HNO_3) at its boiling temperature and current of air removed unstable products. According to Desseigne [21] the method gave *ca.* 80% yield. He used nitric acid of over 50% HNO_3 at 108-110°C.

Isopropyl nitrate is becoming important as an engine starter fuel [22].

p. 165, new references should be inserted:

20. W. G. Allen and T. J. Tobin (to Imperial Chemical Industries Ltd.), *Brit. Pat.* **696489** (1953); see also *Brit. Pats.* **749734** and **749844** (1956).

21. G. Desseigne, *Mém. poudres* **37**, 97 (1955).

22. *Engineer*, London **200**, 269 (1955).

p. 180, lines 16–15 from the bottom should read:

This is the result of the symmetrical structure of PETN. PETN is completely ...

p. 429, last line on the page should read:

(a) in weight %, (b) in mole %.